

KWT[®]
KING WATT LIGHTING

**Professional
Super-excellent
Commercial
LED Lighting Manufacturer**

2023-2024 Ver.

KWT[®]
SHENZHEN KING WATT OPTO-ELECTRONICS CO.,LTD

Shenzhen company address:

Room 1203, Building 2#A, Skyworth Innovation Valley, Songbai Road,
Shiyan, Bao'an District, Shenzhen, China 518108

Dongguan company address:

5th Floor, No. 21 Industrial Park, DiTangLing Road, DaTang Village,
DaLingShan Town, DongGuan City, China. 523820

Tel: +86-755-86062259

Mobile: +86 134-2432-7320 Fax: +86-755-86062219

E-mail: info@kwtled.com

Web: www.kwtled.com



NO QUALITY CONTROL AND CREDIT
NO BRIGHT FUTURE

BRAND CULTURE

Enterprise Mission

Design and manufacture perfect LED lamps
to improve human being's environment

Enterprise Forecast

To be a leading LED commercial lighting enterprise
satisfying customers' demand in market orientation

Core Value

Customer first, sincerity, responsibility and
innovation

Enterprise Spirit

Confidence, teamwork, responsibility and tolerance

Business Philosophy

Honesty, practice and efficiency

Strategy Core

Quality First, Innovation and Breakthrough

Customer Service Philosophy

To be customers' reliable partner

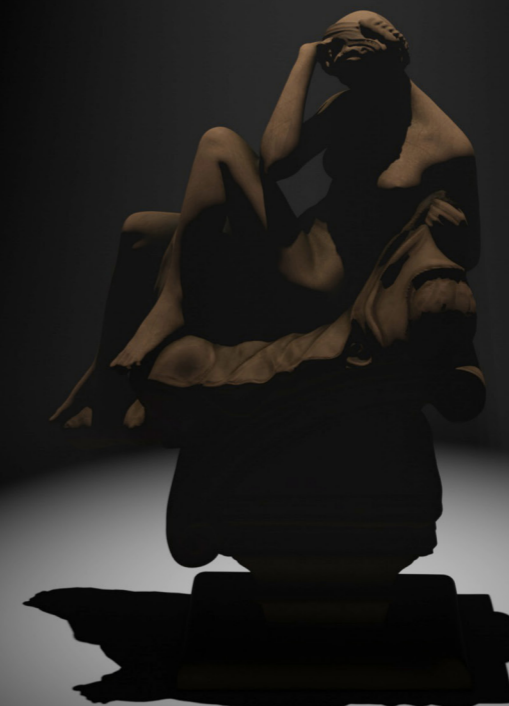



爷爷
于12:45授权远程临时密码

22:25门锁异常, 是否启动报警模式



LIGHTING
is one part of the smart home

LED Digital PWM Dimming

Flicker Free | Dimming minimum to 0.01% | Smooth Dimming | Soft Lighting

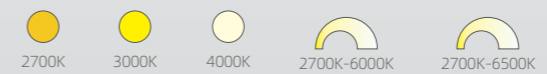
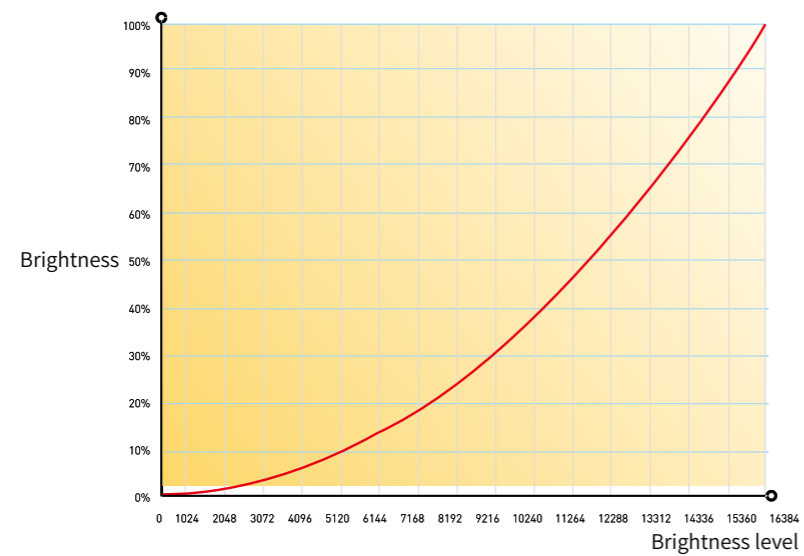

The PWM dimming driver matches all known brand wireless systems perfectly

DEEPLY ANTI GLARE

The both Optical lens and reflectors are designed by KWT , They help to achieve smooth and soft lighting , and deeply anti-glare .

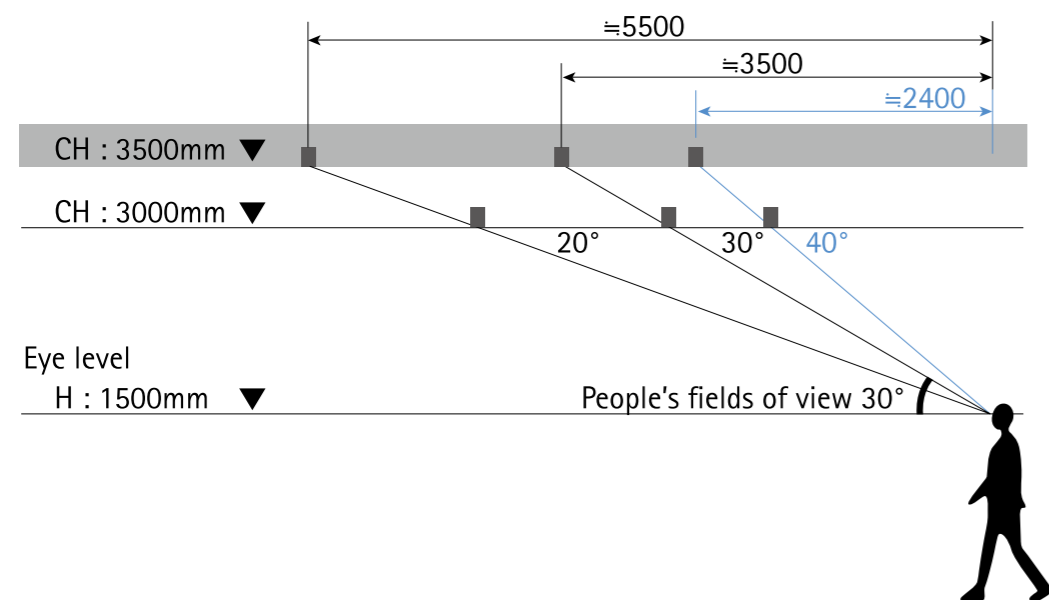
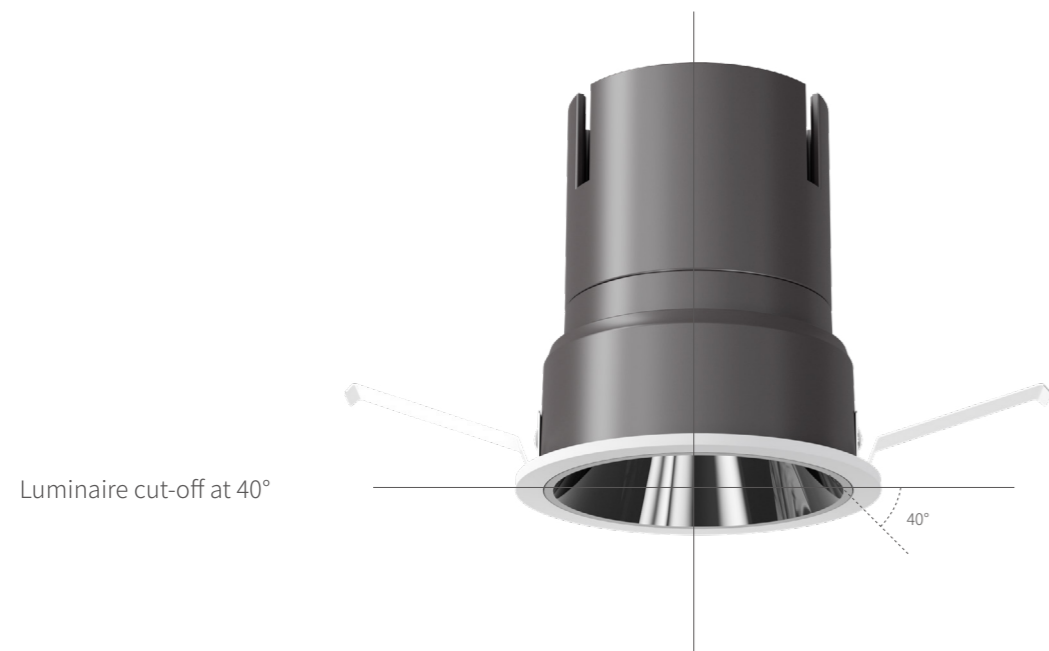

LONG LIFE- SPAN

After mock testing in the special enviroment , we get the result of the light life-span over 40,000 hours

The relationship between LED life time and temperature

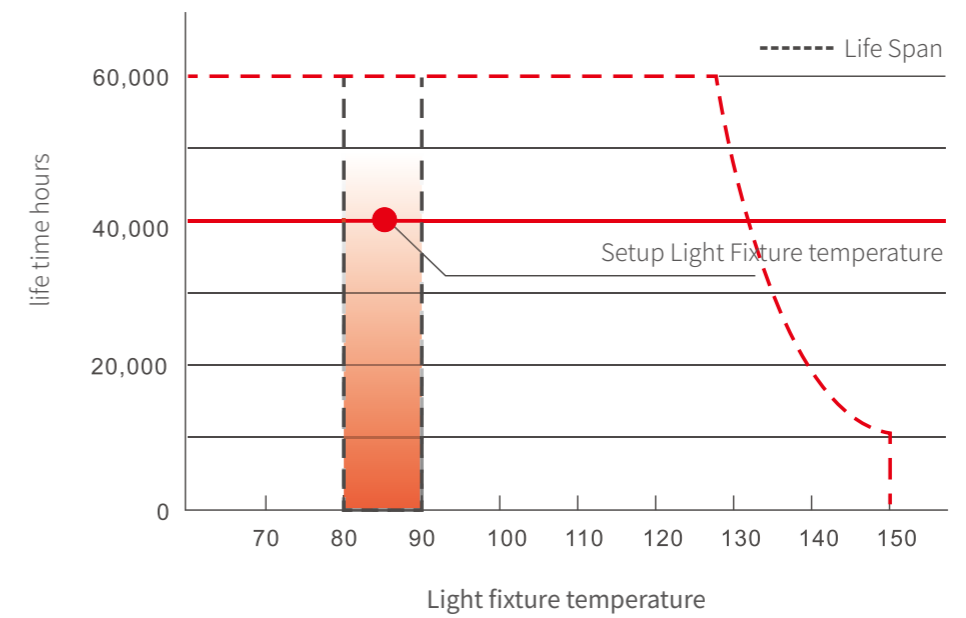

Brightness maintenance rate High brightness maintenance rate , ensure the high lumens of light fixure under life-span

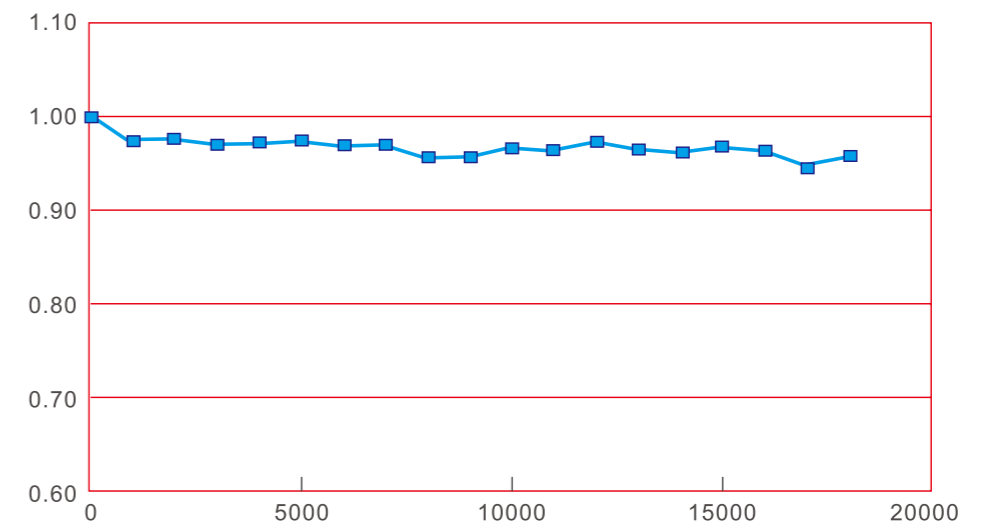

HEAT DISSIPATION

How long the light fixture's life-span, it depend on the performance of heat dissipation . We found a best solution to improve the heat dissipated away faster after mock testing , So the brightness reduction less 6% after 40000 hours .

Mock testing the light fixture works how long hours under highest temperature

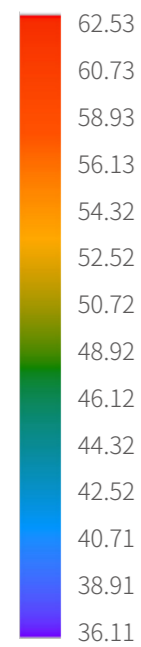

Solid Temperature[°C]

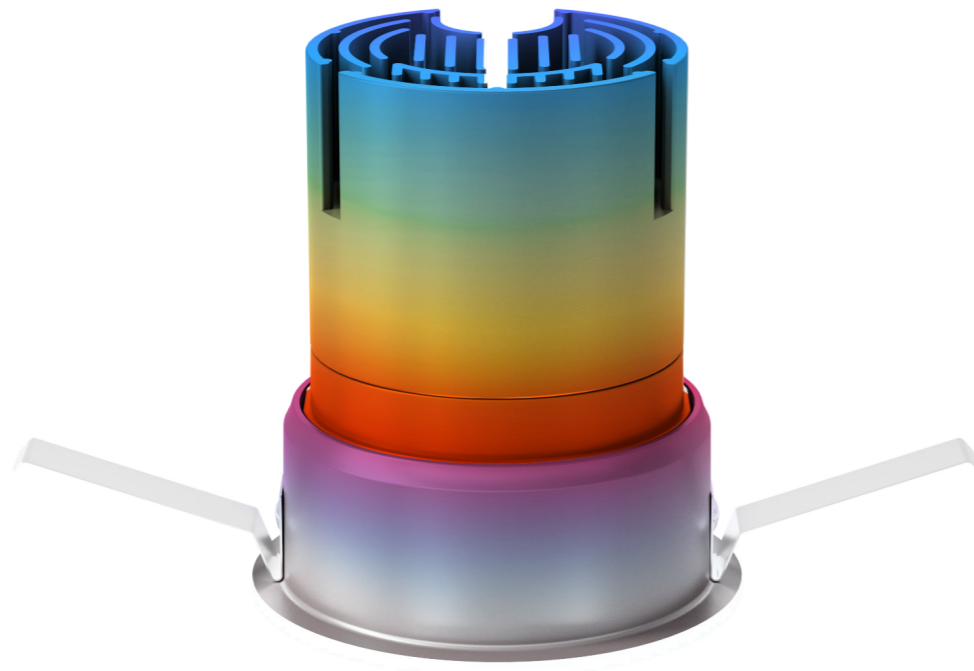

SOLUTION OF FLICKER FREE DRIVER

The driver frequency flicker causes people feel uncomfortable , such as eyes' tired ,headach , have a break down etc .So the flicker free driver is the most important for lighting

Frequency Flicker

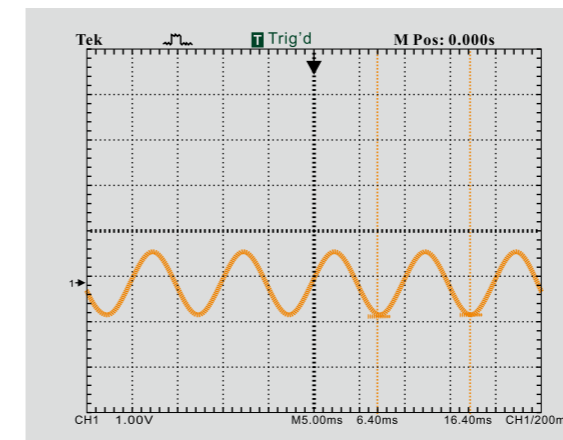

Flicker Free

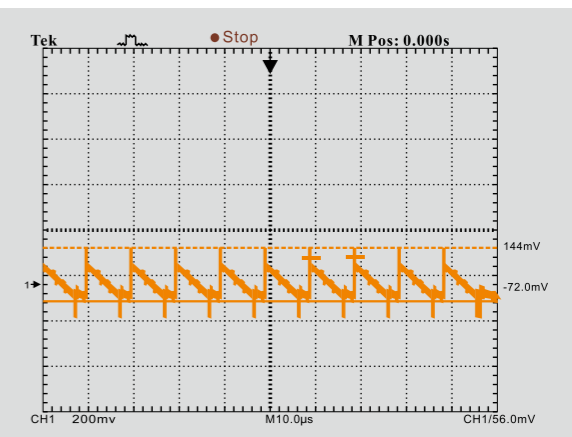
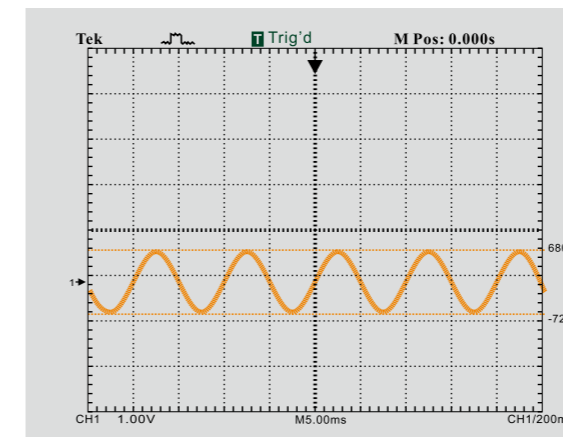
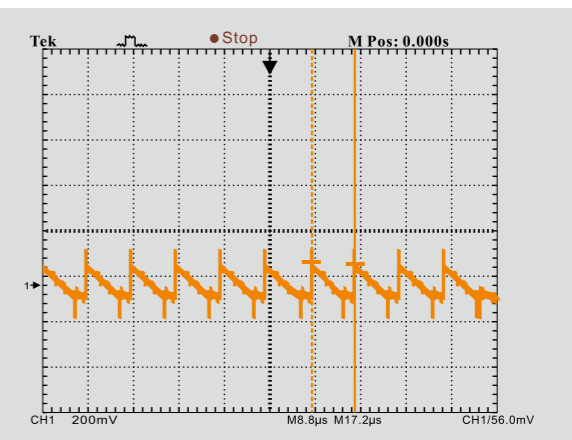

Color Rendering

A color rendering index (CRI) is a quantitative measure of the ability of a light source to reveal the colors of various objects faithfully in comparison with a natural or standard light source. Light sources with a high CRI are desirable in color-critical applications such as neonatal care and art restoration.

Color rendering, as defined by the International Commission on Illumination (CIE), is the effect of an illuminant on the color appearance of objects by conscious or subconscious comparison with their color appearance under a reference or standard illuminant



Scale CRI

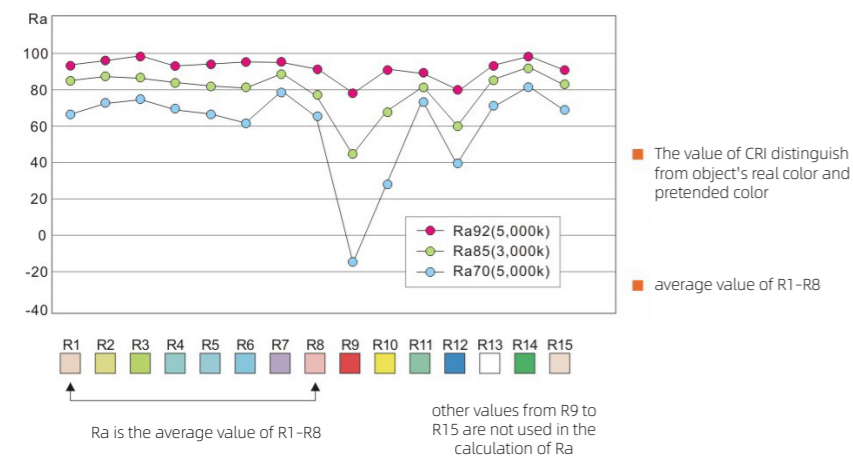

Terminogy	Interpretation
Luminous Flux	Luminous flux is a measure of the power of visible light produced by a light source or light fitting. It is measured in lumens (lm).
Luminous Efficacy	It is the ratio of luminous flux to power, measured in lumens per watt (lm/w) in the International System of Units (SI)
Illuminance	the action of supplying or brightening with light or the resulting state.
Colour Temperature	Color temperature is a way to describe the light appearance provided by a light bulb. It is measured in degrees of Kelvin (K) on a scale from 1,000 to 10,000. Typically, Kelvin temperatures for commercial and residential lighting applications fall somewhere on a scale from 2000K to 6500K.
Junction Temperature	the junction temperature, which is short for transistor junction temperature (semiconductor), is the maximum operating temperature of the actual semiconductor in use in the electronic device. During operation, it is higher than the temperature of the part's exterior and the case temperature

CONTENT

WYNDHAM RECESSED DOWNLIGHT SERIES

P01-P35

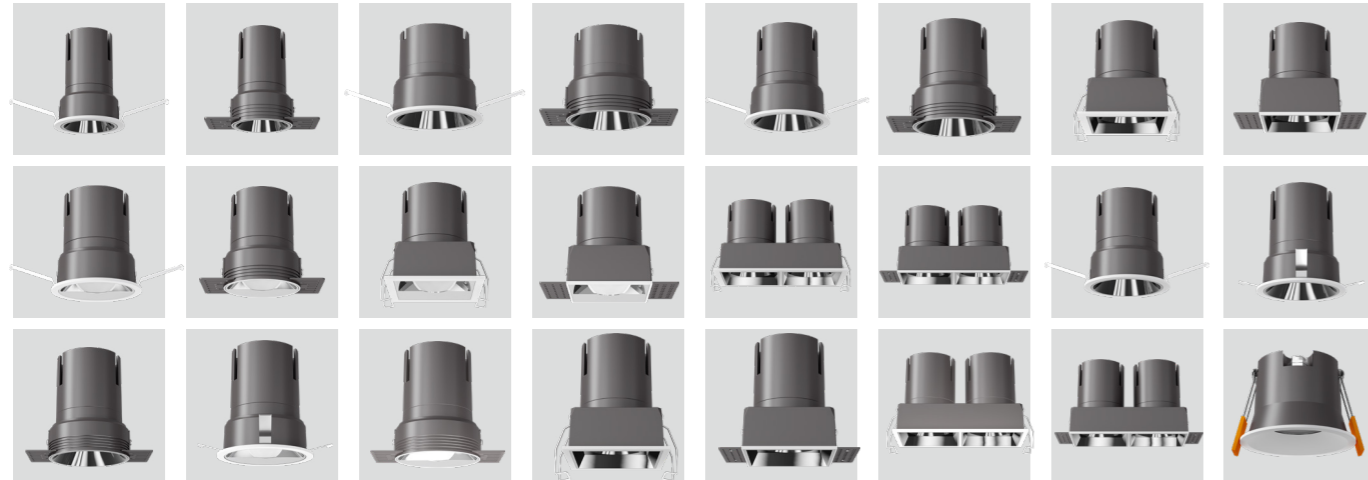

HDM MINI RECESSED DOWNLIGHT SERIES

P36-P41



BULGARI RECESSED DOWNLIGHT SERIES

P42-P59



MGM RECESSED DOWNLIGHT SERIES

P60-P61



DLC RECESSED DOWNLIGHT SERIES

P62-P73



DLD RECESSED DOWNLIGHT SERIES

P62-P73



DLG RECESSED DOWNLIGHT SERIES

P86-P87



DLW & DLS RECESSED DOWNLIGHT SERIES

P88-P90



SURFACE MOUNTED DOWNLIGHT SERIES

P90-P95



PENDANT LAMP SERIES

P96-P99

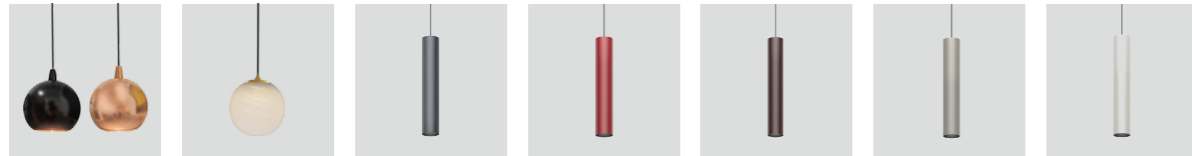

AR111 & GRILLE LIGHT SERIES

P100-P107



LED TRACK LIGHT SERIES

P108-P125



RC RECESSED SPOTLIGHT SERIES

P126-P128



RM SURFACE MOUNTED SPOTLIGHT SERIES

P129-P131



PULL OUT SPOTLIGHT SERIES

P132-P143



MAGNETIC SYSTEM V3.0

P144-P157



MAGNETIC SYSTEM V4.0

P158-P195



MAGNETIC SYSTEM V5.0

P196-P202

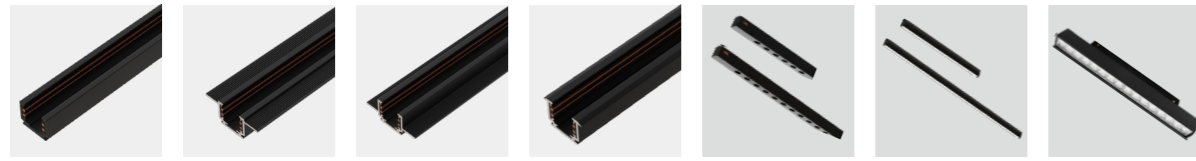

CURVE MAGNETIC SYSTEM V6.0

P203-P205



ARMANI RECESSED LINEAR SERIES

P206-P211

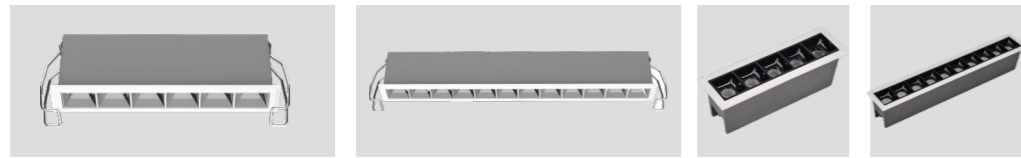

OMEGA RECESSED WALL WASHER LINEAR SERIES

P212-P213



LED FLEXIBLE STRIP SERIES

P214-P221



LINEAR PROFILE SERIES

P222-P239

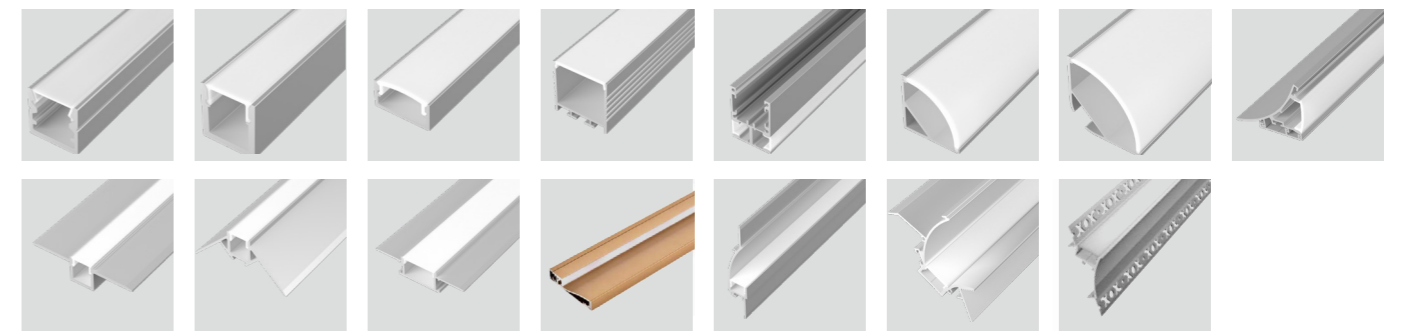

STEP LIGHT SERIES

P240-P243



OFFICE LINEAR LIGHT SERIES

P244-P249

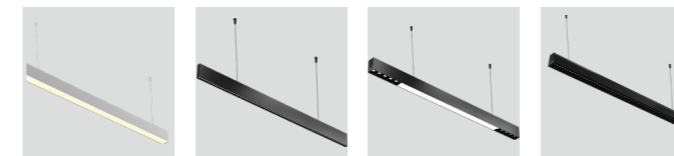

CLASSROOM LIGHT, PANEL LIGHT, HIGHBAY AND STADIUM LIGHT SERIES

P250-P257

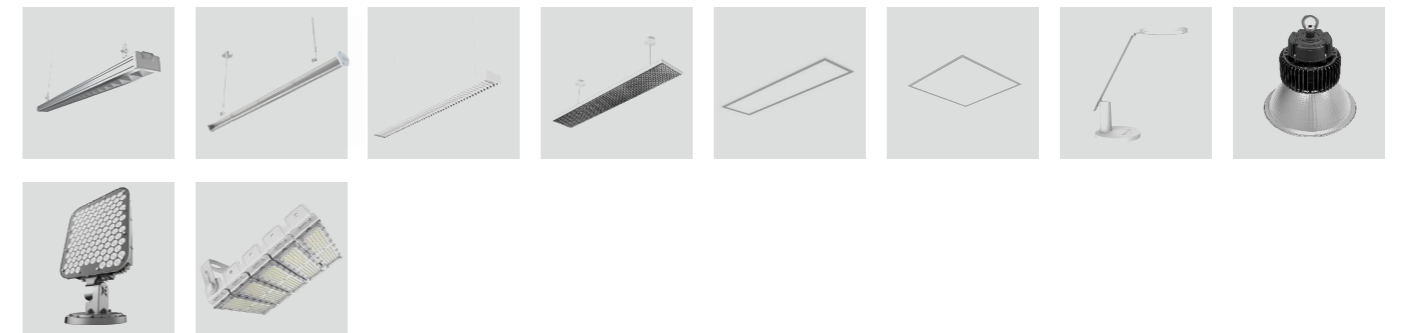

WYNDHAM RECESSED DOWNLIGHT SERIES

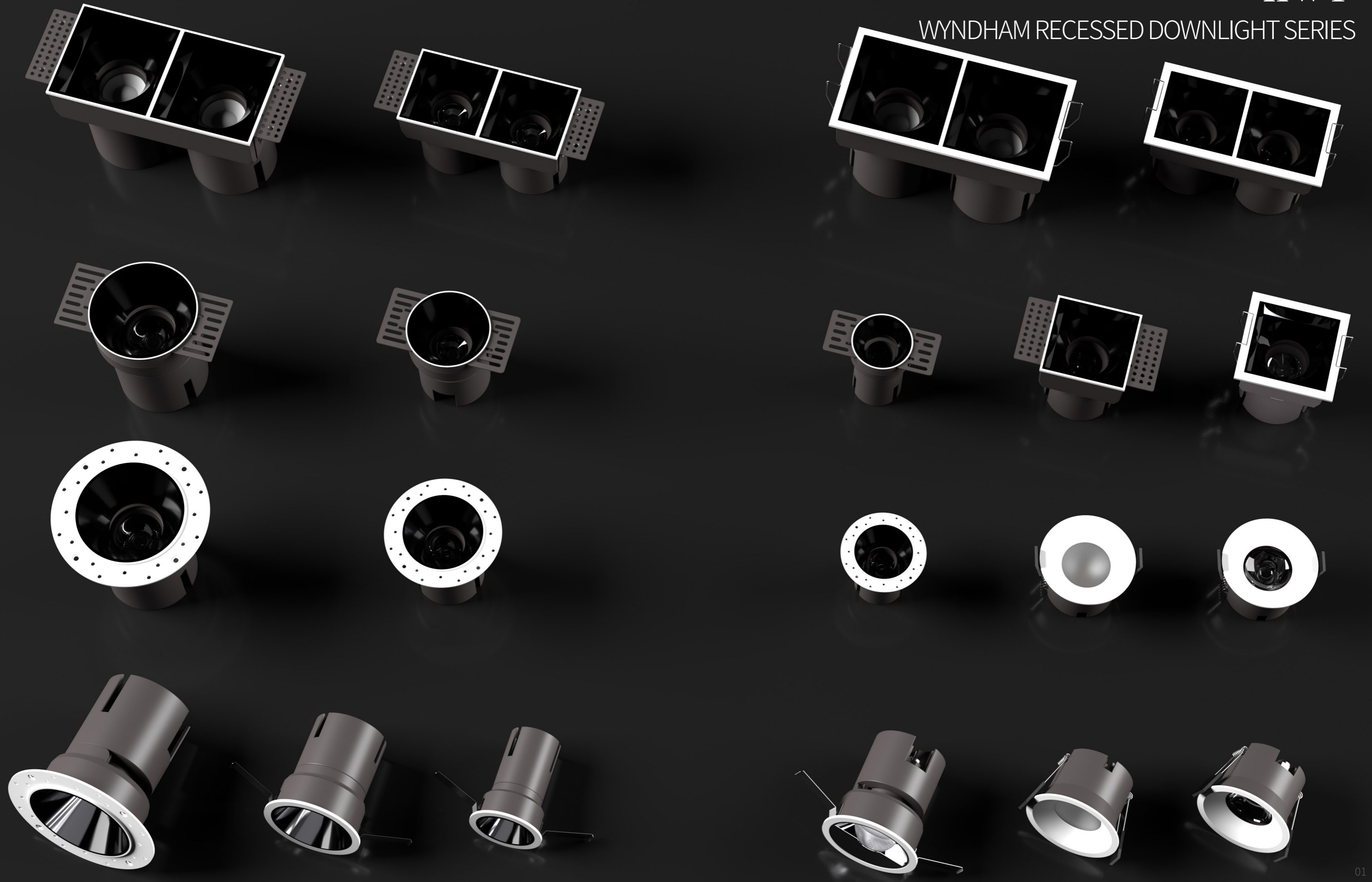

HDL DEEPLY ANTI-GLARE

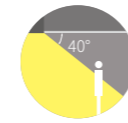

UGR<11
Autonomous anti-glare
Patented optical design



Indoor application



Deep anti dizziness



Accurate light control



Flicker free



High light efficiency



High CRI



IP protection grade
20/65



fireproof



long life



Anti-Glare



Low Light decay



Perfect heat dissipation



different sizes



Multiple light distribution



MODULAR DESIGN
multiple Function and effects

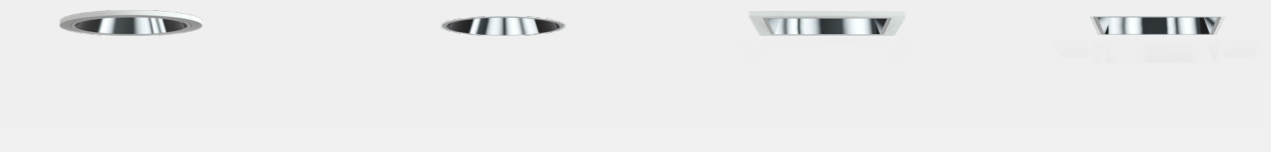
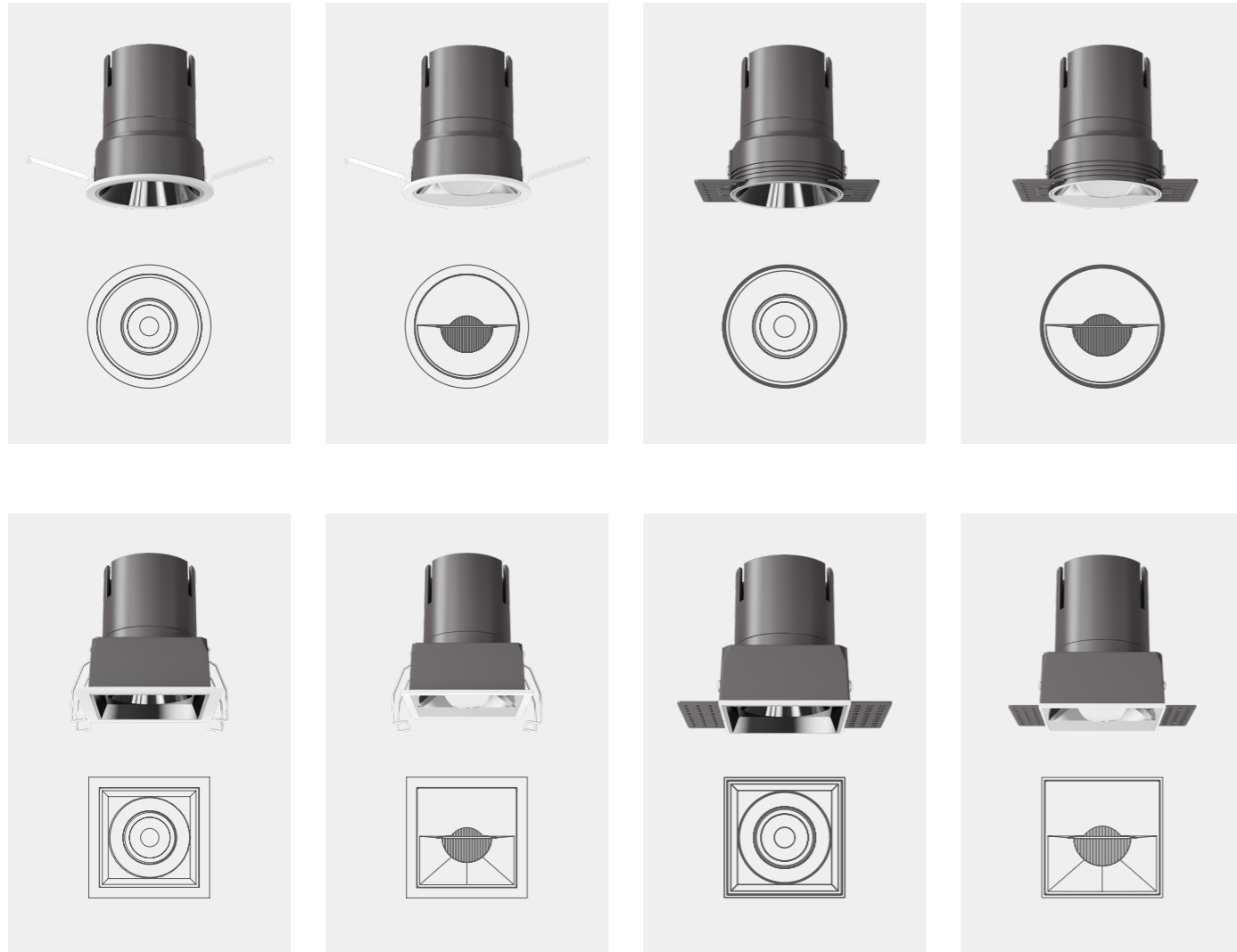

Dazzling black Deep space black Moonlight Silver Linen silver Ivory white Metallic gold



Direct Lighting

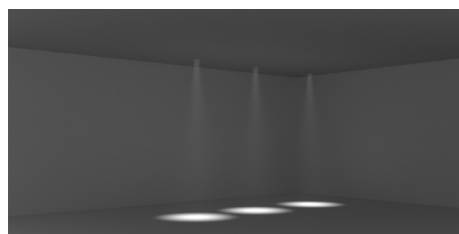

Adjustable Fixture

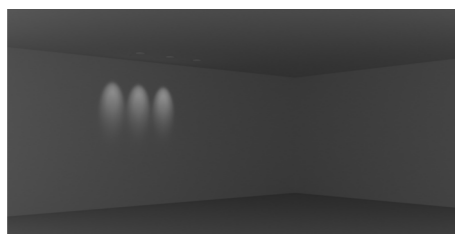

Wall Washer Lighting



circular wall wash cover



Square wall wash cover

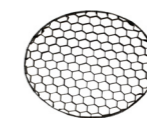

honeycomb



Soft light optical diffuser

WYNDHAM RECESSED
DOWNLIGHT SERIES



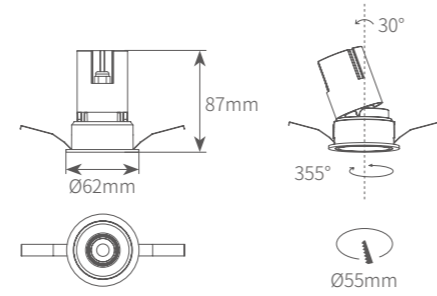

HDL5507

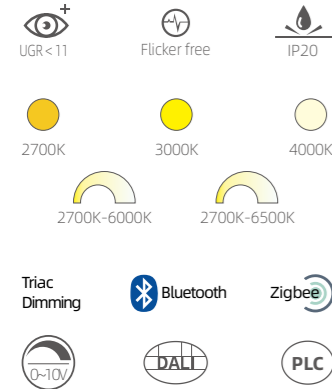

Product information

Power	7W
Beam angle	16°/25°/35°/50°
Input voltage	AC 200-240V
Input frequency	50Hz
System Luminous flux	67Lm/w
CRI	Ra > 90/97
Finish color	Titanium

Product performance

Saturation red reduction degree	R9=90
Color Accuracy	Rf ≥ 92
Color Saturation	Rg=99
Color tolerance	SDCM < 3
Light Fixture Material	Aluminium
Installation	Recessed

Light distribution parameters

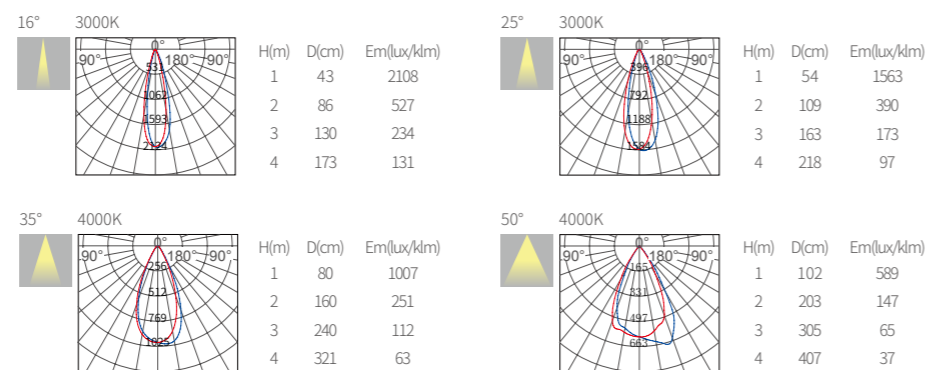

Optional anti glare cover color

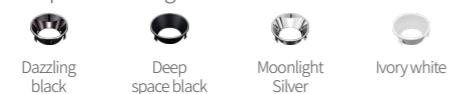

Optional Accessories

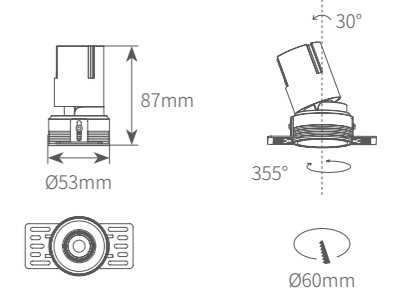
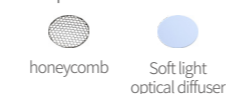

HDL5507-TR

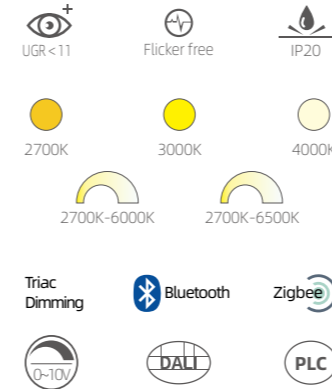

Product information

Power	7W
Beam angle	16°/25°/35°/50°
Input voltage	AC 200-240V
Input frequency	50Hz
System Luminous flux	67Lm/w
CRI	Ra > 90/97
Finish color	Titanium

Product performance

Saturation red reduction degree	R9=90
Color Accuracy	Rf ≥ 92
Color Saturation	Rg=99
Color tolerance	SDCM < 3
Light Fixture Material	Aluminium
Installation	Recessed

Light distribution parameters

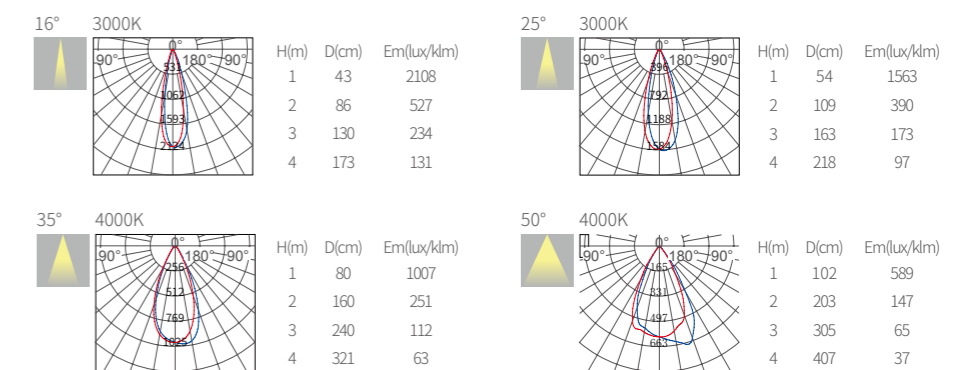

Optional anti glare cover color



Optional Accessories





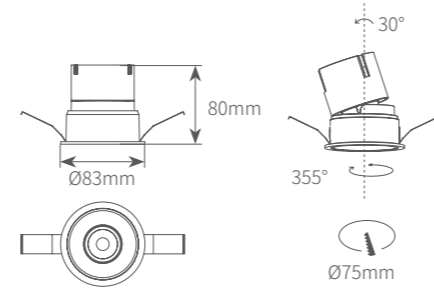

HDL7508

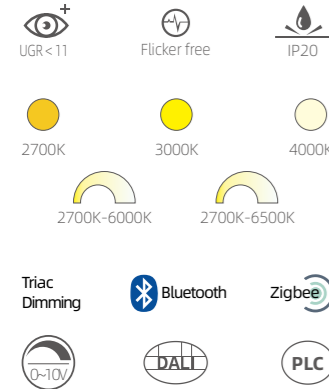

Product information

Power	8W
Beam angle	16°/25°/35°/50°
Input voltage	AC 200-240V
Input frequency	50Hz
System Luminous flux	67Lm/w
CRI	Ra > 90/97
Finish color	Titanium

Product performance

Saturation red reduction degree	R9=90
Color Accuracy	Rf ≥ 92
Color Saturation	Rg=99
Color tolerance	SDCM < 3
Light Fixture Material	Aluminium
Installation	Recessed

Light distribution parameters

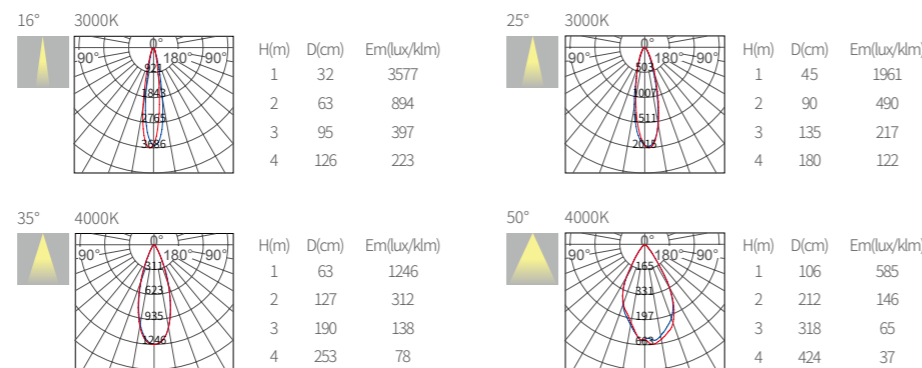

Optional anti glare cover color



Optional Accessories

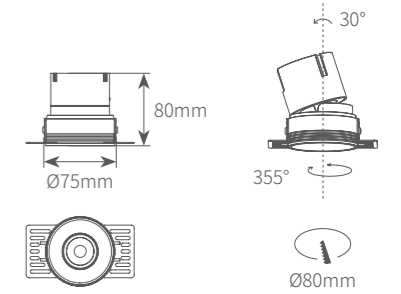
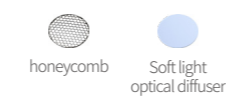

HDL7508-TR

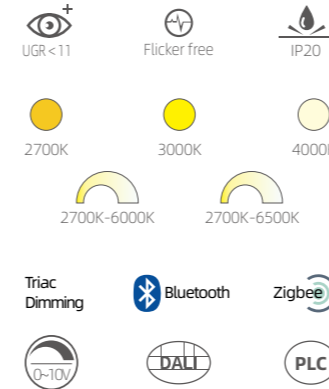

Product information

Power	8W
Beam angle	16°/25°/35°/50°
Input voltage	AC 200-240V
Input frequency	50Hz
System Luminous flux	67Lm/w
CRI	Ra > 90/97
Finish color	Titanium

Product performance

Saturation red reduction degree	R9=90
Color Accuracy	Rf ≥ 92
Color Saturation	Rg=99
Color tolerance	SDCM < 3
Light Fixture Material	Aluminium
Installation	Recessed

Light distribution parameters

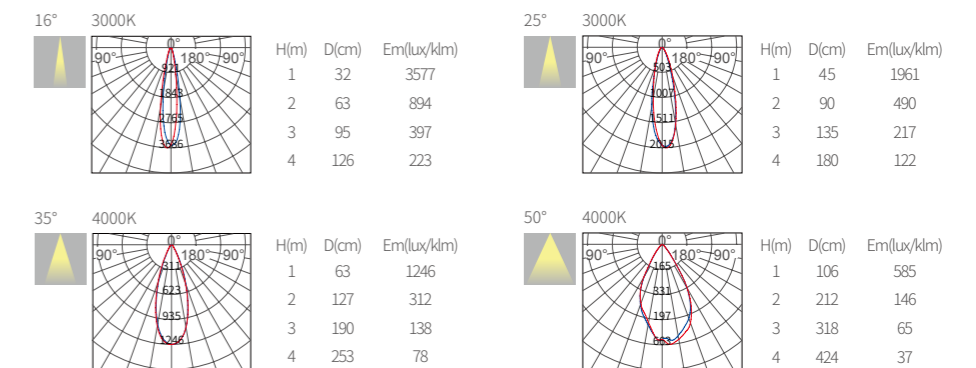

Optional anti glare cover color

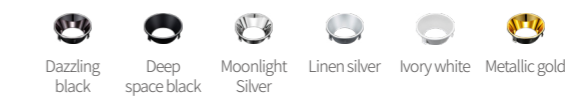

Optional Accessories



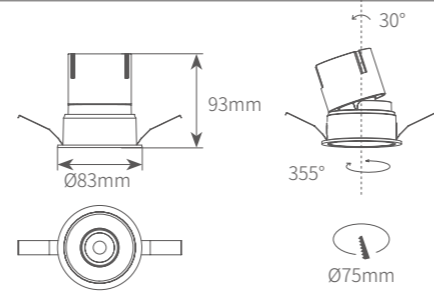

HDL7512

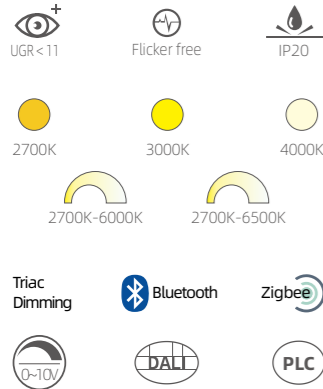

Product information

Power	12W
Beam angle	16°/25°/35°/50°
Input voltage	AC 200-240V
Input frequency	50Hz
System Luminous flux	67Lm/w
CRI	Ra>90/97
Finish color	Titanium

Product performance

Saturation red reduction degree	R9=90
Color Accuracy	Rf≥92
Color Saturation	Rg=99
Color tolerance	SDCM<3
Light Fixture Material	Aluminium
Installation	Recessed

Light distribution parameters

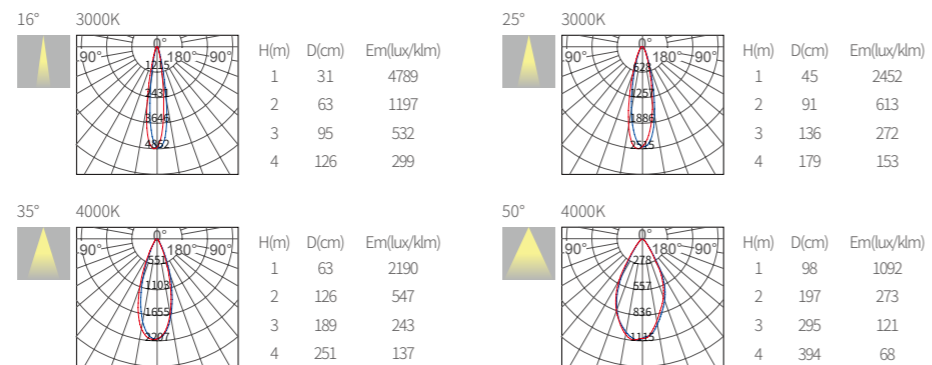

Optional anti glare cover color



Optional Accessories

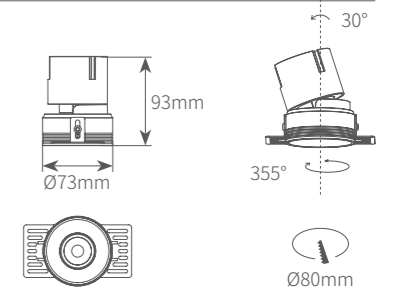
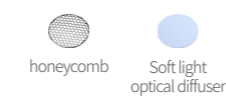

HDL7512-TR

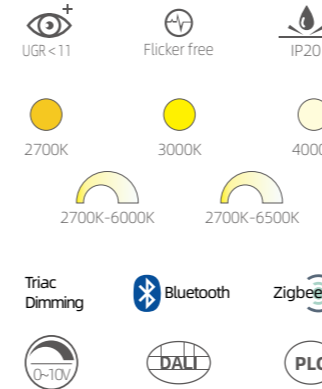

Product information

Power	12W
Beam angle	16°/25°/35°/50°
Input voltage	AC 200-240V
Input frequency	50Hz
System Luminous flux	67Lm/w
CRI	Ra>90/97
Finish color	Titanium

Product performance

Saturation red reduction degree	R9=90
Color Accuracy	Rf≥92
Color Saturation	Rg=99
Color tolerance	SDCM<3
Light Fixture Material	Aluminium
Installation	Recessed

Light distribution parameters

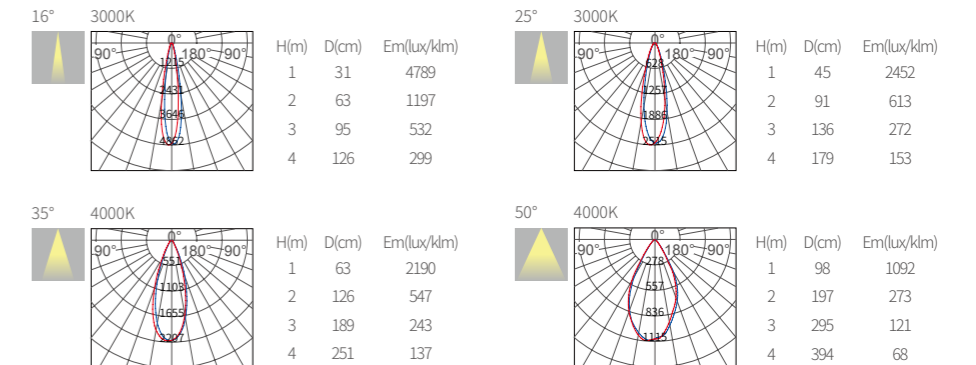

Optional anti glare cover color

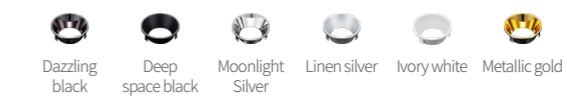

Optional Accessories



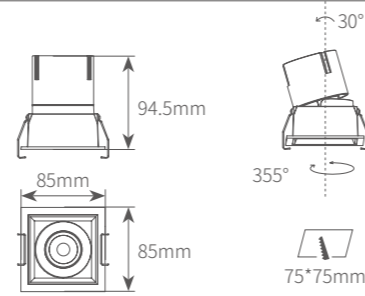
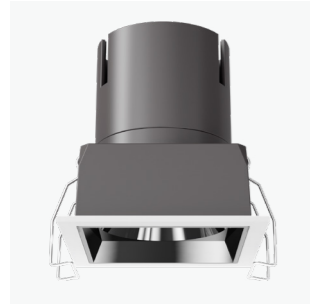

HDLS7512

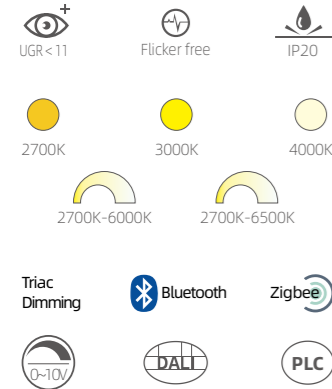

Product information

Power	12W
Beam angle	16°/25°/35°/50°
Input voltage	AC 200-240V
Input frequency	50Hz
System Luminous flux	67Lm/w
CRI	Ra > 90/97
Finish color	Titanium

Product performance

Saturation red reduction degree	R9=90
Color Accuracy	Rf ≥ 92
Color Saturation	Rg=99
Color tolerance	SDCM < 3
Light Fixture Material	Aluminium
Installation	Recessed

Light distribution parameters

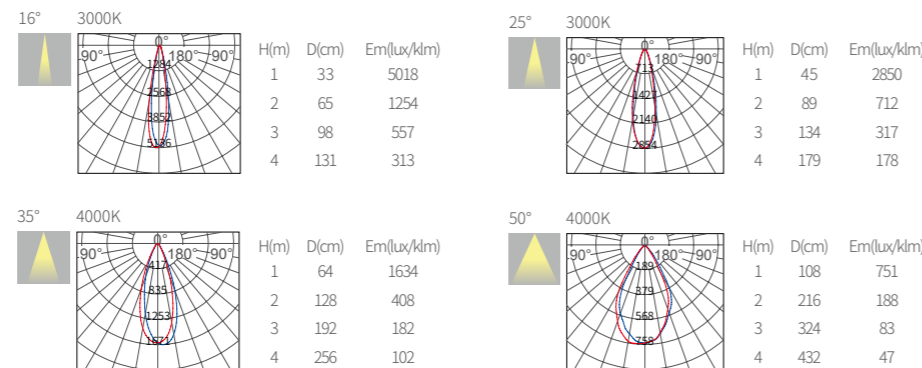

Optional anti glare cover color



Optional Accessories

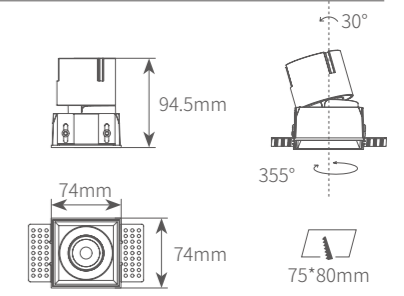
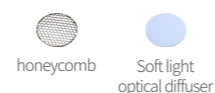

HDLS7512-TR

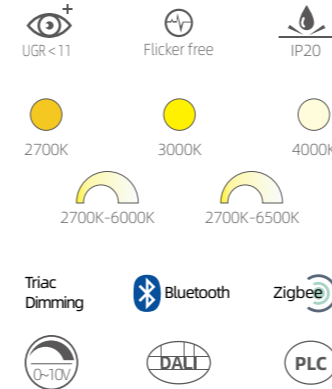

Product information

Power	12W
Beam angle	16°/25°/35°/50°
Input voltage	AC 200-240V
Input frequency	50Hz
System Luminous flux	67Lm/w
CRI	Ra > 90/97
Finish color	Titanium

Product performance

Saturation red reduction degree	R9=90
Color Accuracy	Rf ≥ 92
Color Saturation	Rg=99
Color tolerance	SDCM < 3
Light Fixture Material	Aluminium
Installation	Recessed

Light distribution parameters

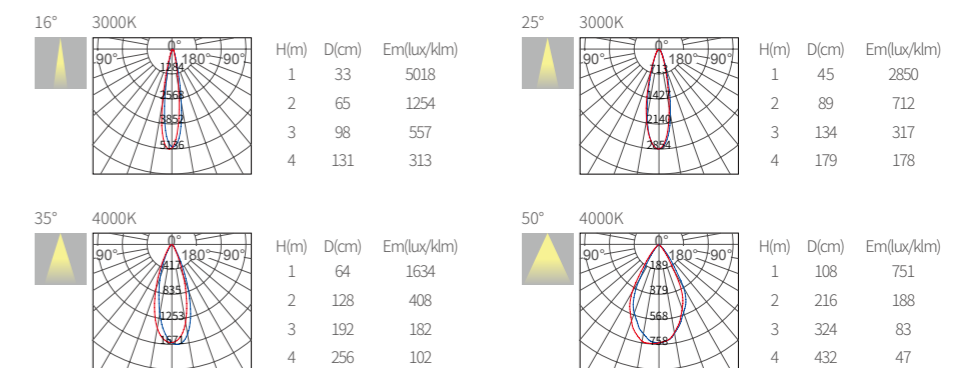

Optional anti glare cover color



Optional Accessories

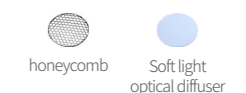

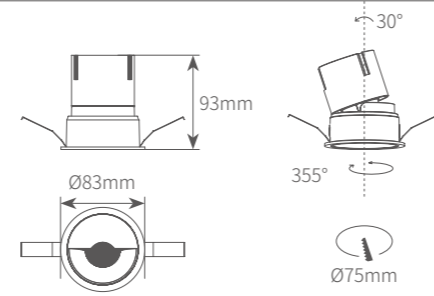

HDL7512-W

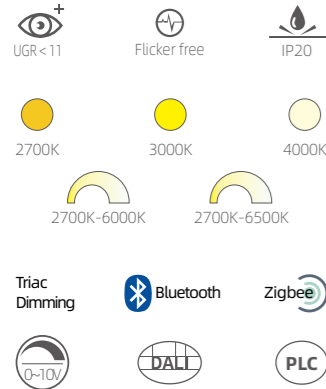

Product information

Power	12W
Beam angle	35°-70°
Input voltage	AC 200-240V
Input frequency	50Hz
System Luminous flux	67Lm/w
CRI	Ra > 90/97
Finish color	Titanium

Product performance

Saturation red reduction degree	R9=90
Color Accuracy	Rf ≥ 92
Color Saturation	Rg=99
Color tolerance	SDCM < 3
Light Fixture Material	Aluminium
Installation	Recessed

Light distribution parameters

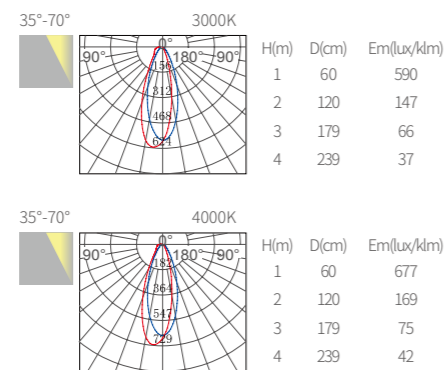

Optional anti glare cover color



Dazzling black / Deep space black / Moonlight Silver / Linen silver / Ivory white

Optional Accessories

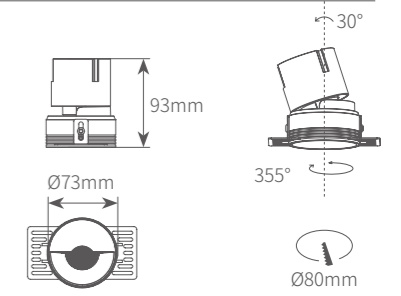

HDL7512-TR-W

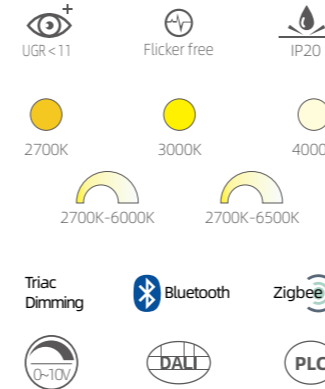

Product information

Power	12W
Beam angle	35°-70°
Input voltage	AC 200-240V
Input frequency	50Hz
System Luminous flux	67Lm/w
CRI	Ra > 90/97
Finish color	Titanium

Product performance

Saturation red reduction degree	R9=90
Color Accuracy	Rf ≥ 92
Color Saturation	Rg=99
Color tolerance	SDCM < 3
Light Fixture Material	Aluminium
Installation	Recessed

Light distribution parameters

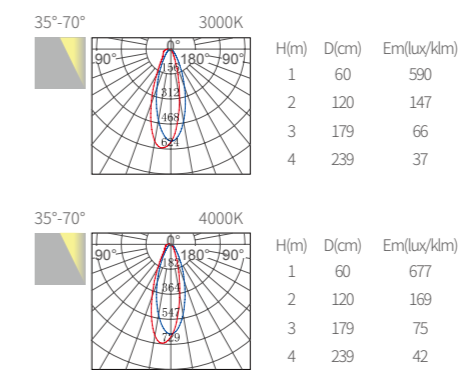

Optional anti glare cover color



Dazzling black / Deep space black / Moonlight Silver / Linen silver / Ivory white

Optional Accessories



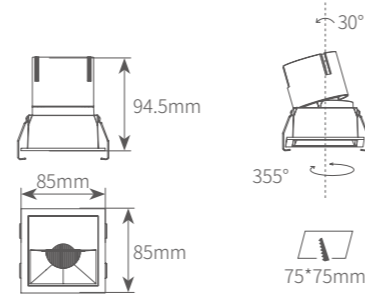
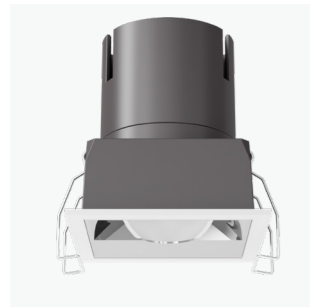

HDLS7512-W

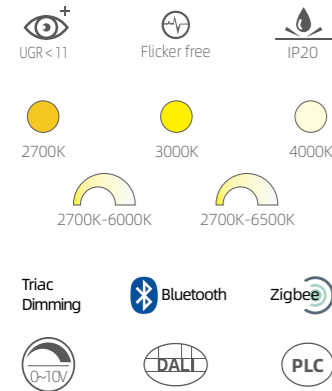

Product information

Power	12W
Beam angle	35°-70°
Input voltage	AC 200-240V
Input frequency	50Hz
System Luminous flux	67Lm/w
CRI	Ra > 90/97
Finish color	Titanium

Product performance

Saturation red reduction degree	R9=90
Color Accuracy	Rf ≥ 92
Color Saturation	Rg=99
Color tolerance	SDCM < 3
Light Fixture Material	Aluminium
Installation	Recessed

Light distribution parameters

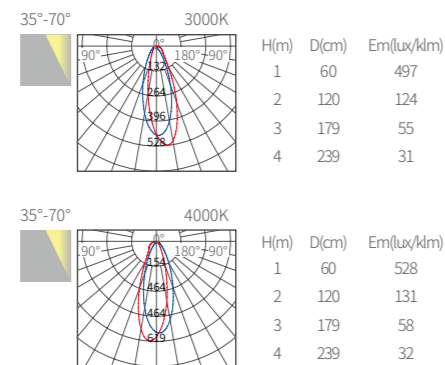

Optional anti glare cover color



Dazzling black / Deep space black / Moonlight Silver / Linen silver / Ivory white

Optional Accessories

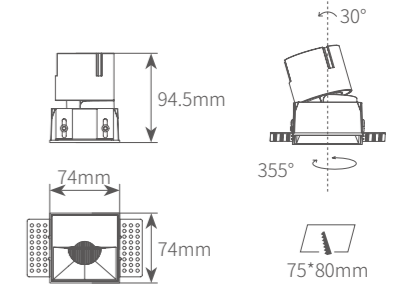

HDLS7512-TR-W

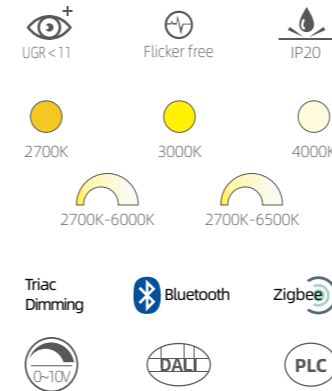

Product information

Power	12W
Beam angle	35°-70°
Input voltage	AC 200-240V
Input frequency	50Hz
System Luminous flux	67Lm/w
CRI	Ra > 90/97
Finish color	Titanium

Product performance

Saturation red reduction degree	R9=90
Color Accuracy	Rf ≥ 92
Color Saturation	Rg=99
Color tolerance	SDCM < 3
Light Fixture Material	Aluminium
Installation	Recessed

Light distribution parameters

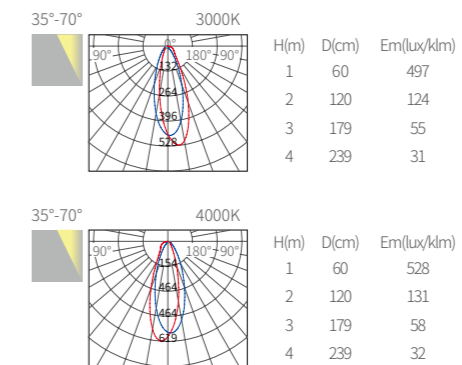

Optional anti glare cover color



Dazzling black / Deep space black / Moonlight Silver / Linen silver / Ivory white

Optional Accessories



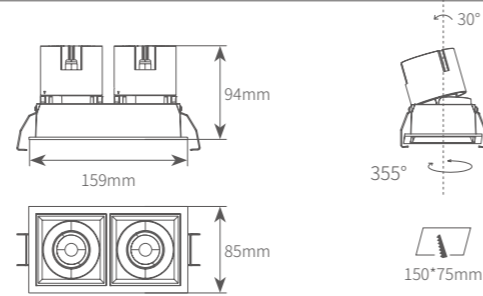

HDLS15075

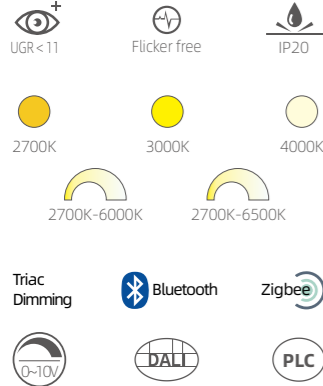

Product information

Power	12W*2
Beam angle	16°/25°/35°/50°
Input voltage	AC 200-240V
Input frequency	50Hz
System Luminous flux	67Lm/w
CRI	Ra > 90/97
Finish color	Titanium

Product performance

Saturation red reduction degree	R9=90
Color Accuracy	Rf ≥ 92
Color Saturation	Rg=99
Color tolerance	SDCM < 3
Light Fixture Material	Aluminium
Installation	Recessed

Light distribution parameters

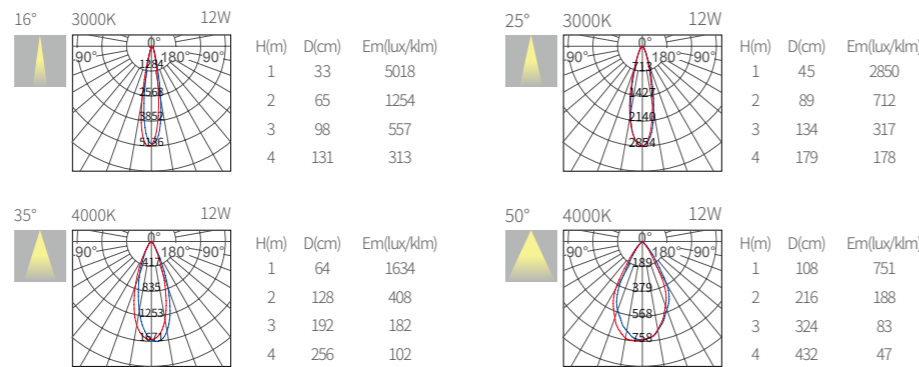

Optional anti glare cover color



Optional Accessories

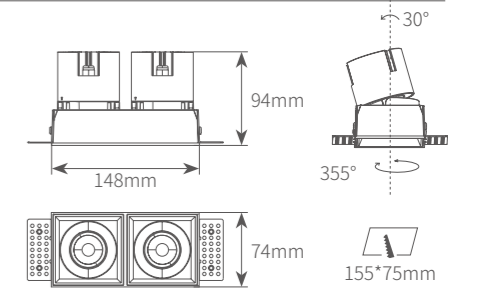
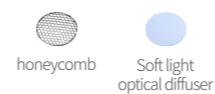

HDLS15075-TR

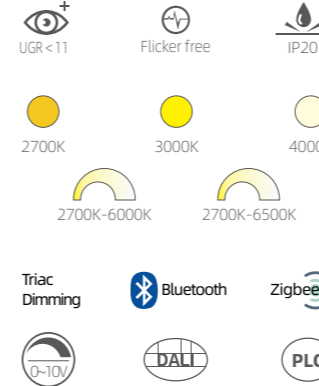

Product information

Power	12W*2
Beam angle	16°/25°/35°/50°
Input voltage	AC 200-240V
Input frequency	50Hz
System Luminous flux	67Lm/w
CRI	Ra > 90/97
Finish color	Titanium

Product performance

Saturation red reduction degree	R9=90
Color Accuracy	Rf ≥ 92
Color Saturation	Rg=99
Color tolerance	SDCM < 3
Light Fixture Material	Aluminium
Installation	Recessed

Light distribution parameters

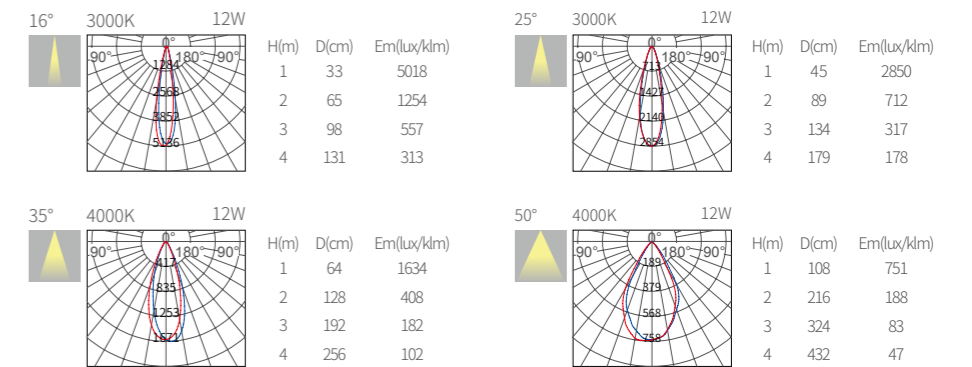

Optional anti glare cover color



Optional Accessories

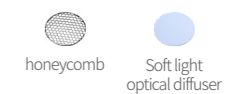

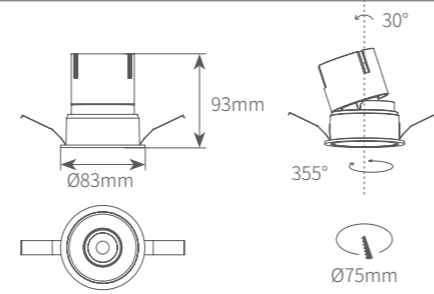

HDL7512-RGB-CW

Color Effect

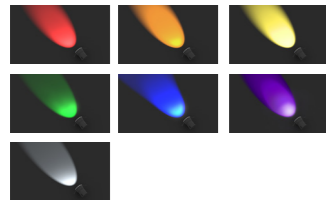

Product information

Power	12W
Beam angle	16°/25°/35°/50°
Input voltage	AC 200-240V
Input frequency	50Hz
System Luminous flux	67Lm/w
CRI	Ra>90/97
Finish color	Titanium

Product performance

Saturation red reduction degree	R9=90
Color Accuracy	Rf≥92
Color Saturation	Rg=99
Color tolerance	SDCM<3
Light Fixture Material	Aluminium
Installation	Recessed



Light distribution parameters

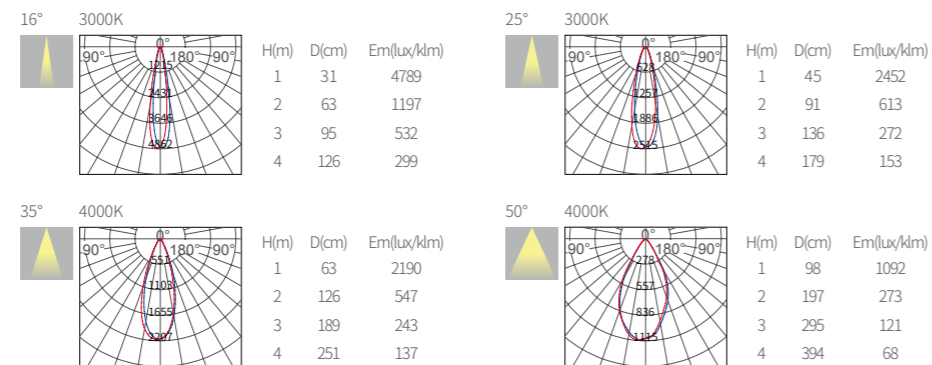

Optional anti glare cover color



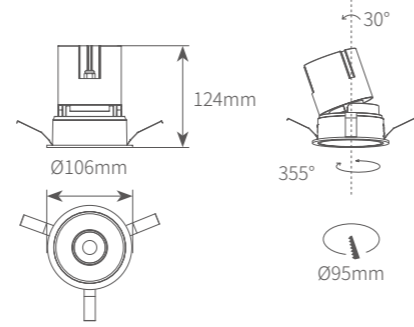

HDL9520

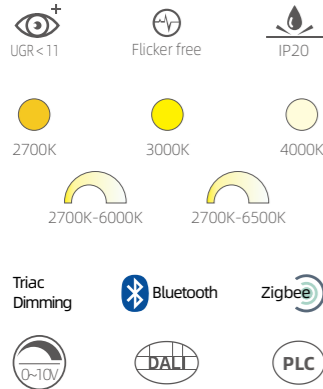

Product information

Power	20W
Beam angle	20°/30°/40°/60°
Input voltage	AC 200-240V
Input frequency	50Hz
System Luminous flux	67Lm/w
CRI	Ra > 90/97
Finish color	Titanium

Product performance

Saturation red reduction degree	R9=90
Color Accuracy	Rf ≥ 92
Color Saturation	Rg=99
Color tolerance	SDCM < 3
Light Fixture Material	Aluminium
Installation	Recessed

Light distribution parameters

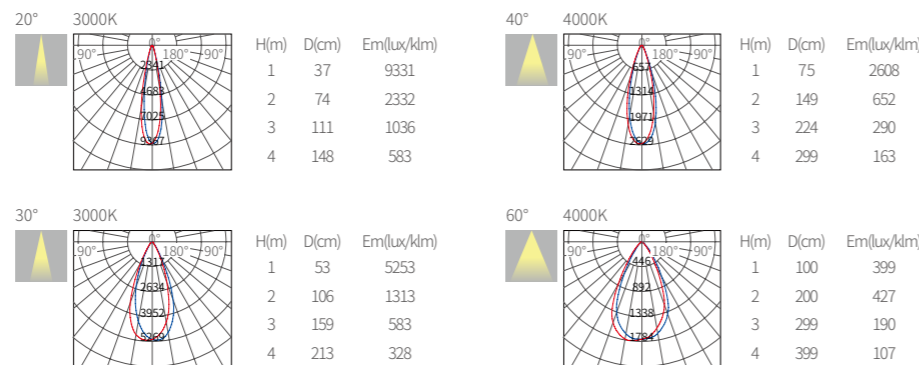

Optional anti glare cover color



Optional Accessories

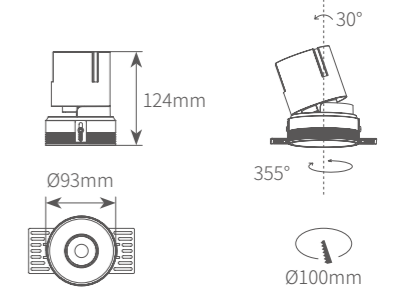
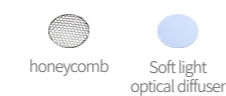

HDL9520-TR

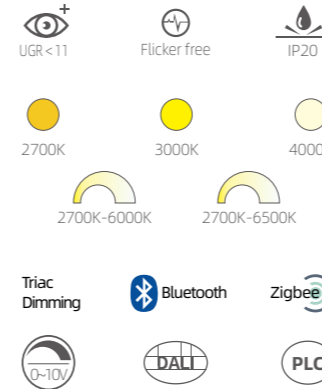

Product information

Power	20W
Beam angle	20°/30°/40°/60°
Input voltage	AC 200-240V
Input frequency	50Hz
System Luminous flux	67Lm/w
CRI	Ra > 90/97
Finish color	Titanium

Product performance

Saturation red reduction degree	R9=90
Color Accuracy	Rf ≥ 92
Color Saturation	Rg=99
Color tolerance	SDCM < 3
Light Fixture Material	Aluminium
Installation	Recessed

Light distribution parameters

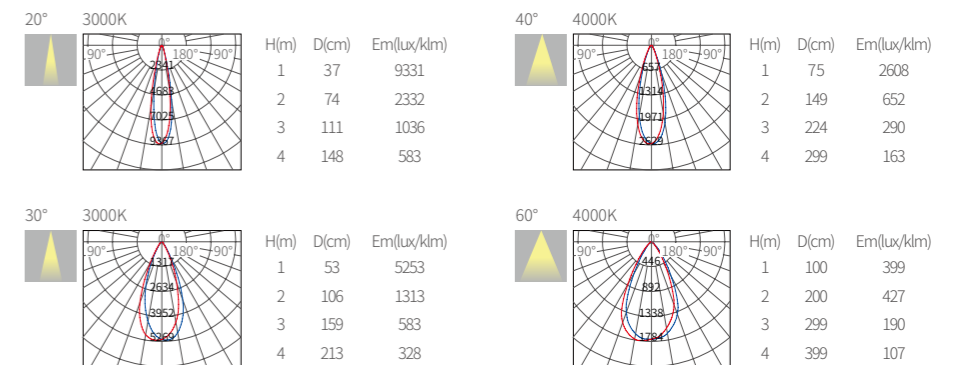

Optional anti glare cover color

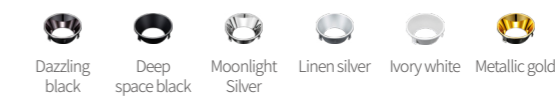

Optional Accessories

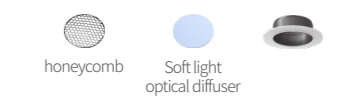

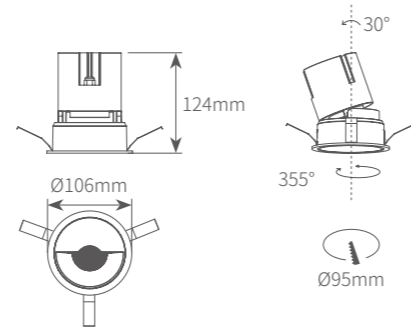

HDL9520-W

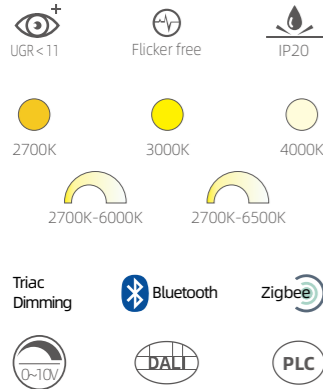

Product information

Power	20W
Beam angle	35°-70°
Input voltage	AC 200-240V
Input frequency	50Hz
System Luminous flux	67Lm/w
CRI	Ra > 90/97
Finish color	Titanium

Product performance

Saturation red reduction degree	R9=90
Color Accuracy	Rf ≥ 92
Color Saturation	Rg=99
Color tolerance	SDCM < 3
Light Fixture Material	Aluminium
Installation	Recessed

Light distribution parameters

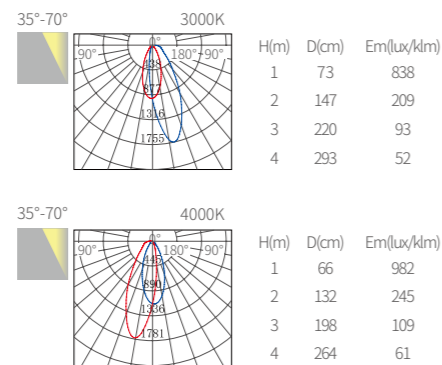

Optional anti glare cover color

Dazzling black / Deep space black / Moonlight Silver / Linen silver / Ivory white

Optional Accessories

honeycomb Soft light optical diffuser

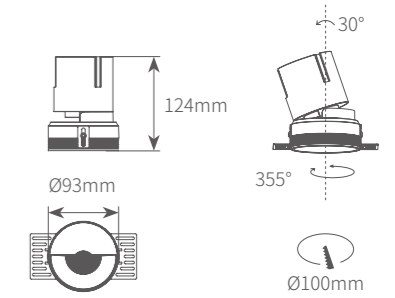

HDL9520-TR-W

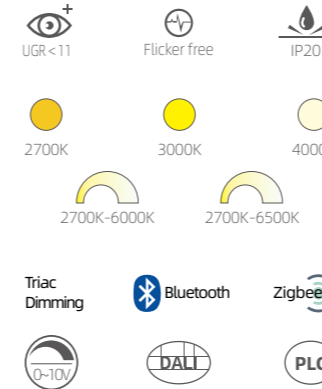

Product information

Power	20W
Beam angle	35°-70°
Input voltage	AC 200-240V
Input frequency	50Hz
System Luminous flux	67Lm/w
CRI	Ra > 90/97
Finish color	Titanium

Product performance

Saturation red reduction degree	R9=90
Color Accuracy	Rf ≥ 92
Color Saturation	Rg=99
Color tolerance	SDCM < 3
Light Fixture Material	Aluminium
Installation	Recessed

Light distribution parameters

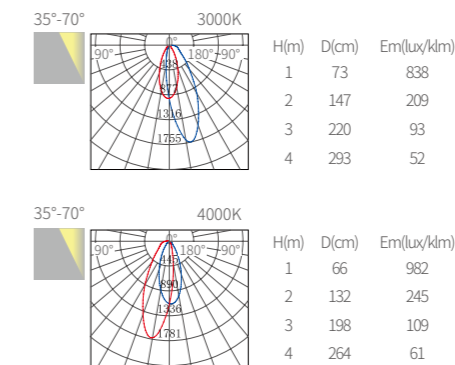

Optional anti glare cover color

Dazzling black / Deep space black / Moonlight Silver / Linen silver / Ivory white

Optional Accessories

honeycomb Soft light optical diffuser



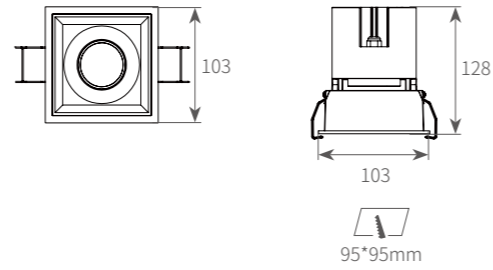

HDLS9520

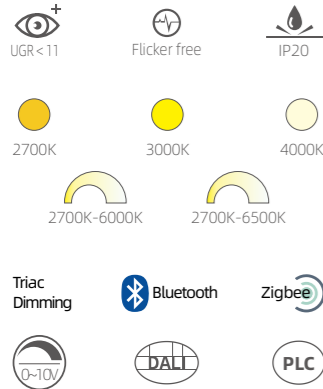

Product information

Power	20W
Beam angle	35°-70°
Input voltage	AC 200-240V
Input frequency	50Hz
System Luminous flux	67Lm/w
CRI	Ra > 90/97
Finish color	Titanium

Product performance

Saturation red reduction degree	R9=90
Color Accuracy	Rf ≥ 92
Color Saturation	Rg=99
Color tolerance	SDCM < 3
Light Fixture Material	Aluminium
Installation	Recessed

Light distribution parameters

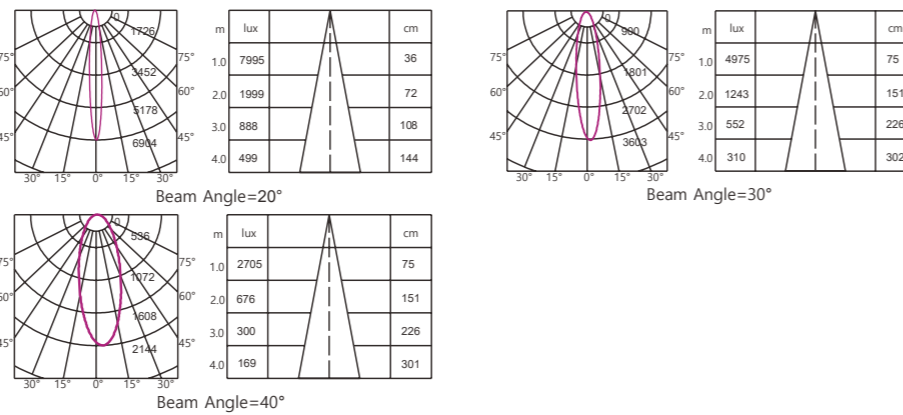

Optional anti glare cover color



Optional Accessories

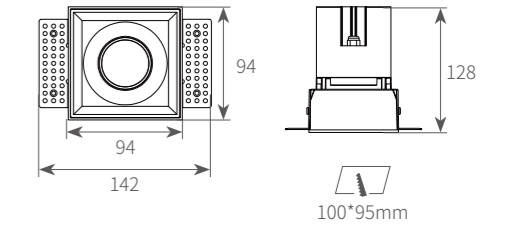
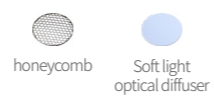

HDLS9520-TR

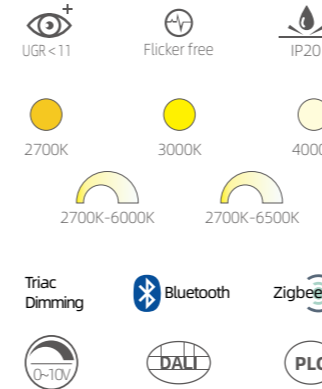

Product information

Power	20W
Beam angle	35°-70°
Input voltage	AC 200-240V
Input frequency	50Hz
System Luminous flux	67Lm/w
CRI	Ra > 90/97
Finish color	Titanium

Product performance

Saturation red reduction degree	R9=90
Color Accuracy	Rf ≥ 92
Color Saturation	Rg=99
Color tolerance	SDCM < 3
Light Fixture Material	Aluminium
Installation	Recessed

Light distribution parameters

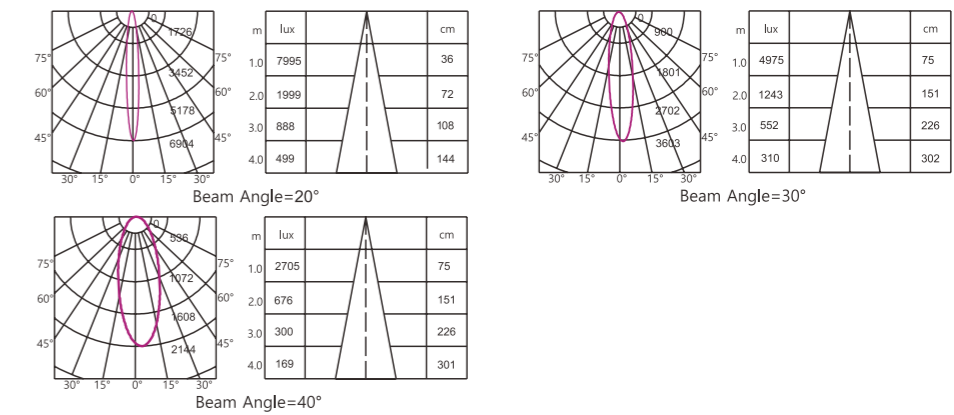

Optional anti glare cover color



Optional Accessories

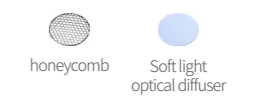

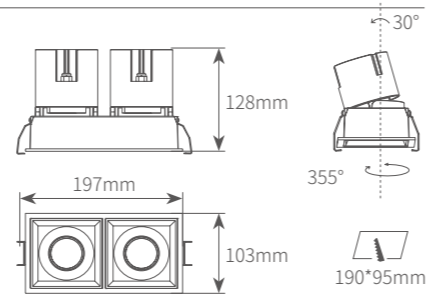

HDLS19095

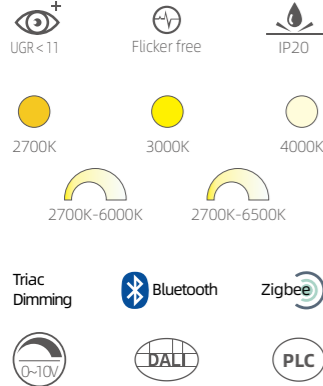

Product information

Power	20W*2
Beam angle	20°/30°/40°/60°
Input voltage	AC 200-240V
Input frequency	50Hz
System Luminous flux	67Lm/w
CRI	Ra > 90/97
Finish color	Titanium

Product performance

Saturation red reduction degree	R9=90
Color Accuracy	Rf ≥ 92
Color Saturation	Rg=99
Color tolerance	SDCM < 3
Light Fixture Material	Aluminium
Installation	Recessed

Light distribution parameters

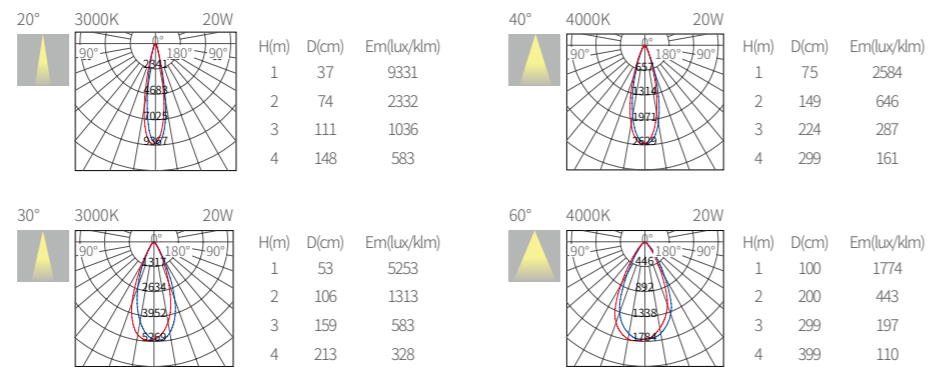

Optional anti glare cover color



Optional Accessories

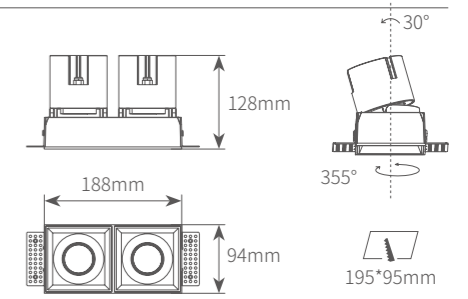
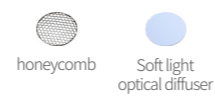

HDLS19095-TR

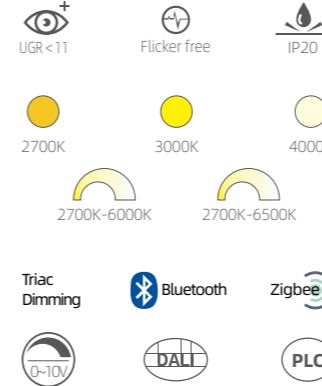

Product information

Power	20W*2
Beam angle	20°/30°/40°/60°
Input voltage	AC 200-240V
Input frequency	50Hz
System Luminous flux	67Lm/w
CRI	Ra > 90/97
Finish color	Titanium

Product performance

Saturation red reduction degree	R9=90
Color Accuracy	Rf ≥ 92
Color Saturation	Rg=99
Color tolerance	SDCM < 3
Light Fixture Material	Aluminium
Installation	Recessed

Light distribution parameters

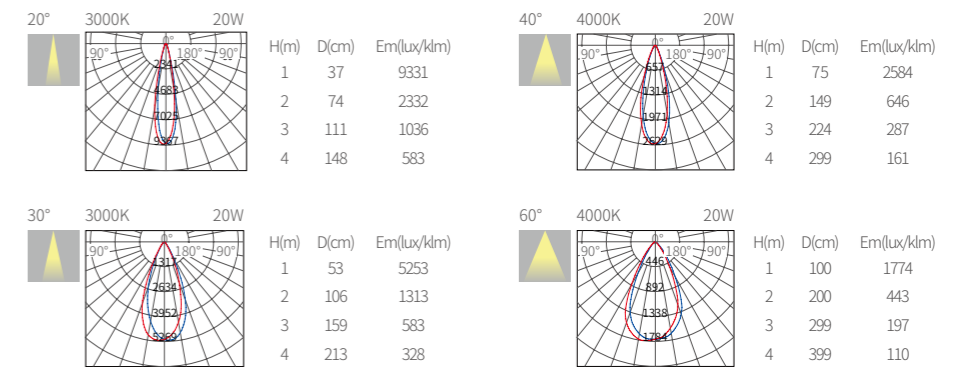

Optional anti glare cover color



Optional Accessories

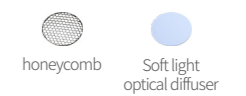



IP54

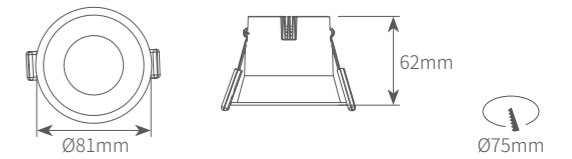

HDL7512FR

Product information

Power	12W
Beam angle	80°
Input voltage	AC 200-240V
Input frequency	50Hz
System Luminous flux	75Lm/w
CRI	Ra>90/97
Finish color	Titanium

Product performance

Saturation red reduction degree	R9=90
Color Accuracy	Rf≥92
Color Saturation	Rg=99
Color tolerance	SDCM<3
Light Fixture Material	Aluminium
Installation	Recessed

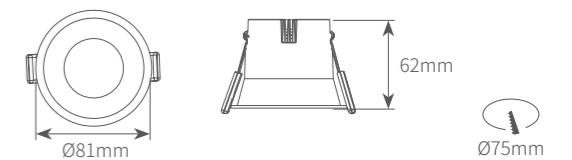
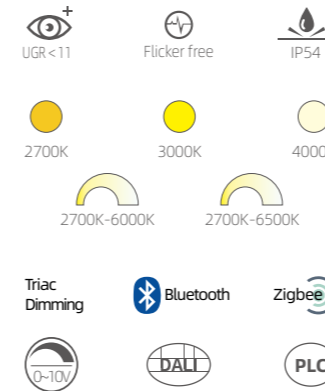

HDL7512FL

Product information

Power	12W
Beam angle	16°/25°/35°/50°
Input voltage	AC 200-240V
Input frequency	50Hz
System Luminous flux	75Lm/w
CRI	Ra>90/97
Finish color	Titanium

Product performance

Saturation red reduction degree	R9=90
Color Accuracy	Rf≥92
Color Saturation	Rg=99
Color tolerance	SDCM<3
Light Fixture Material	Aluminium
Installation	Recessed

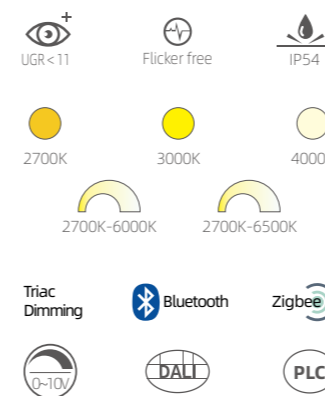

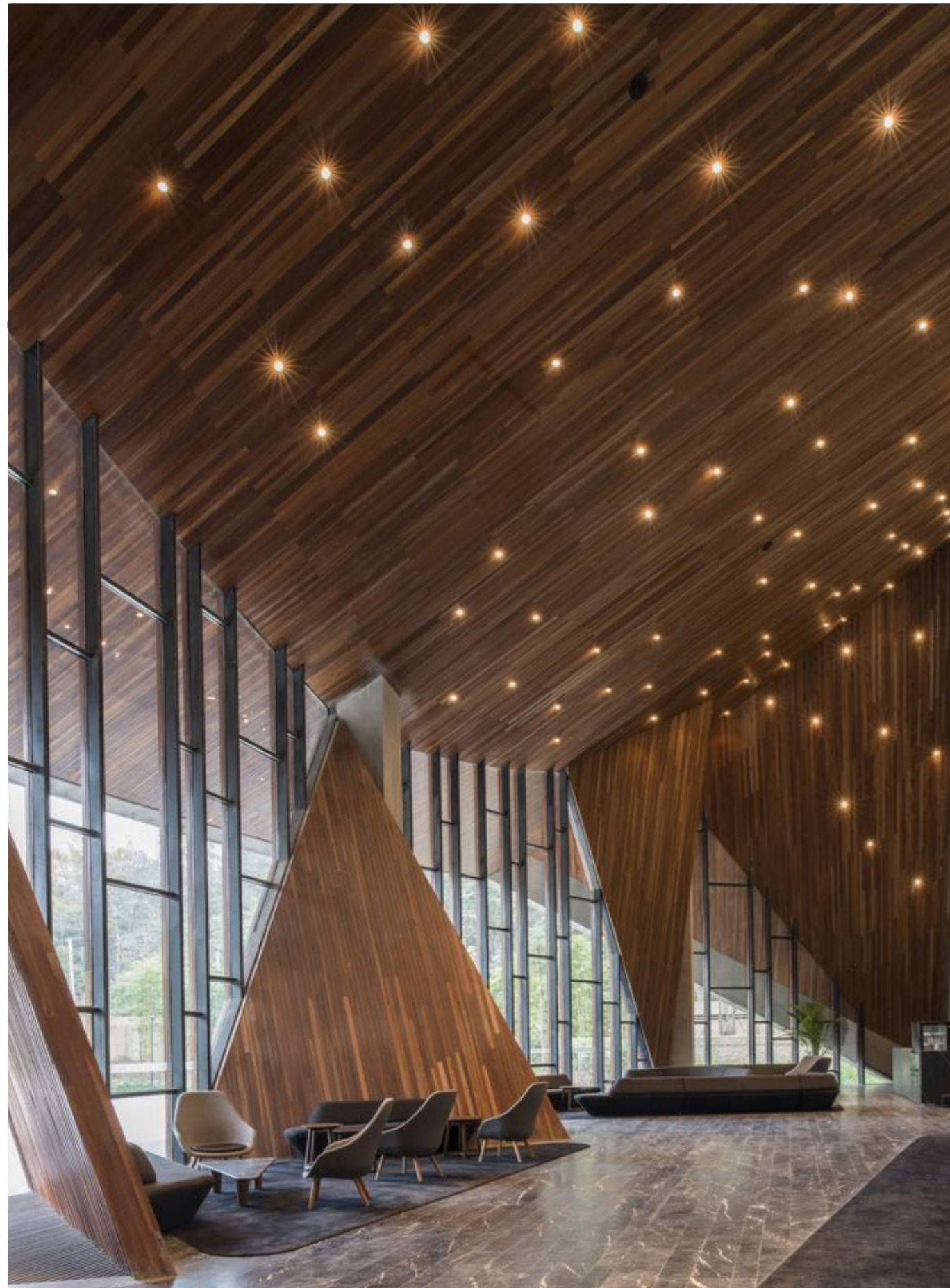

HDM Deep Deeply-Glare

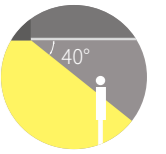

UGR<11

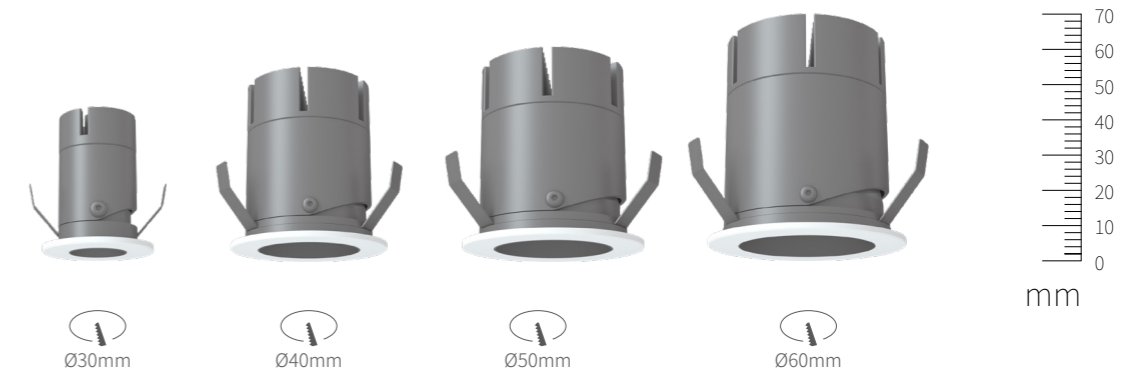

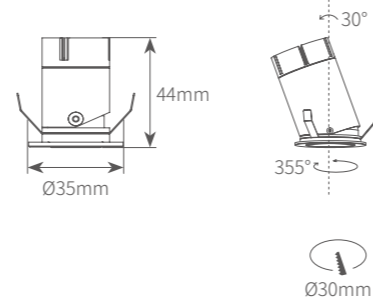

HDM3001G

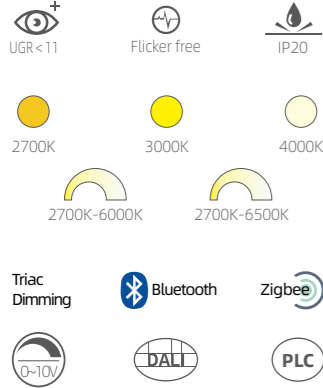

Product information

Power	1W
Beam angle	15°/24°/36°
Input voltage	AC 200-240V
Input frequency	50Hz
System Luminous flux	67Lm/w
CRI	Ra > 90/97
Finish color	Titanium

Product performance

Saturation red reduction degree	R9=90
Color Accuracy	Rf ≥ 92
Color Saturation	Rg=99
Color tolerance	SDCM < 3
Light Fixture Material	Aluminium
Installation	Recessed

Light distribution parameters

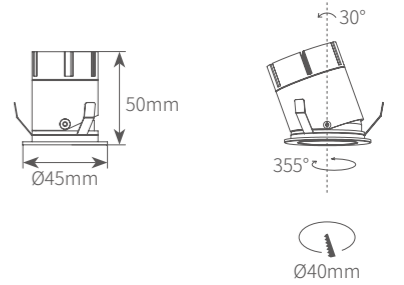
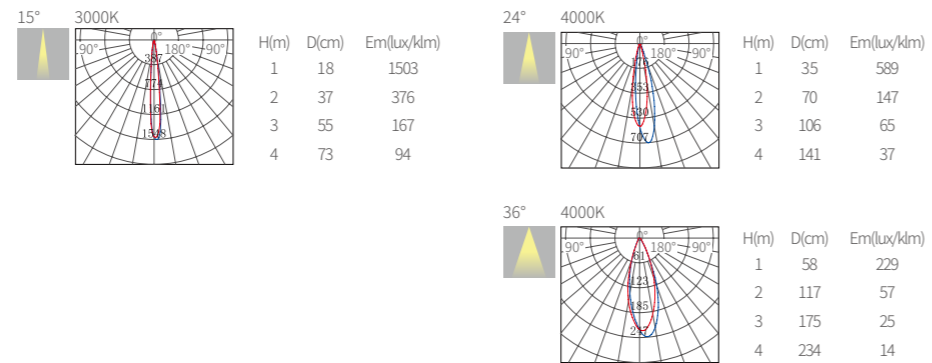

HDM4003G

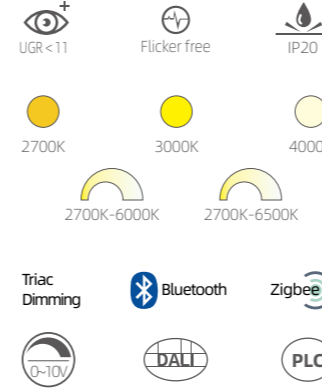

Product information

Power	3W
Beam angle	15°/24°/36°
Input voltage	AC 200-240V
Input frequency	50Hz
System Luminous flux	67Lm/w
CRI	Ra > 90/97
Finish color	Titanium

Product performance

Saturation red reduction degree	R9=90
Color Accuracy	Rf ≥ 92
Color Saturation	Rg=99
Color tolerance	SDCM < 3
Light Fixture Material	Aluminium
Installation	Recessed

Light distribution parameters

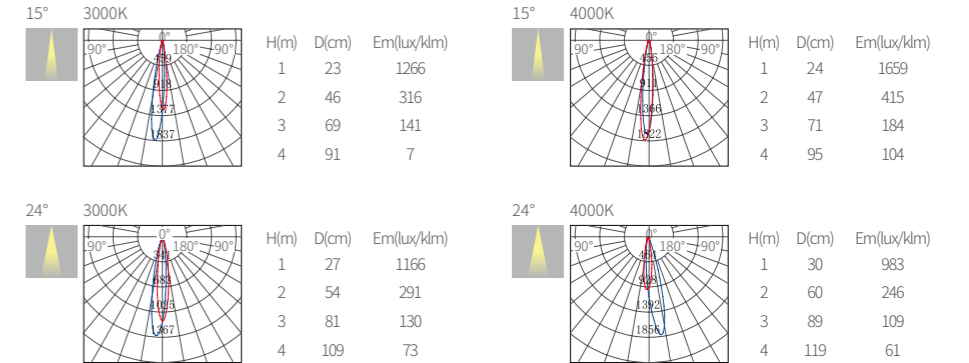

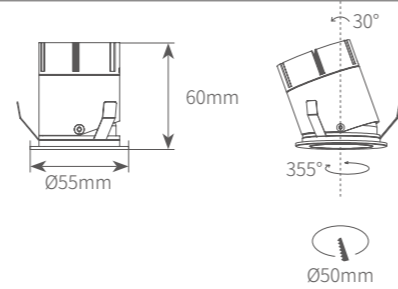

HDM5005G

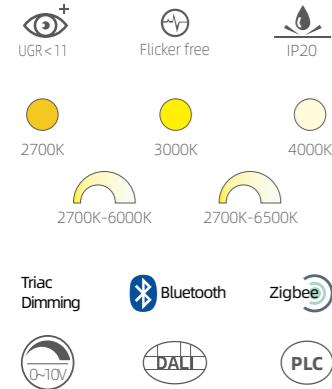

Product information

Power	5W
Beam angle	35°/45°
Input voltage	AC 200-240V
Input frequency	50Hz
System Luminous flux	67Lm/w
CRI	Ra > 90/97
Finish color	Titanium

Product performance

Saturation red reduction degree	R9=90
Color Accuracy	Rf ≥ 92
Color Saturation	Rg=99
Color tolerance	SDCM < 3
Light Fixture Material	Aluminium
Installation	Recessed

Light distribution parameters

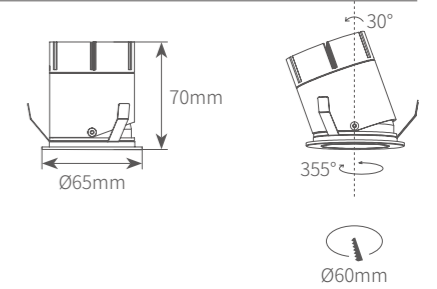
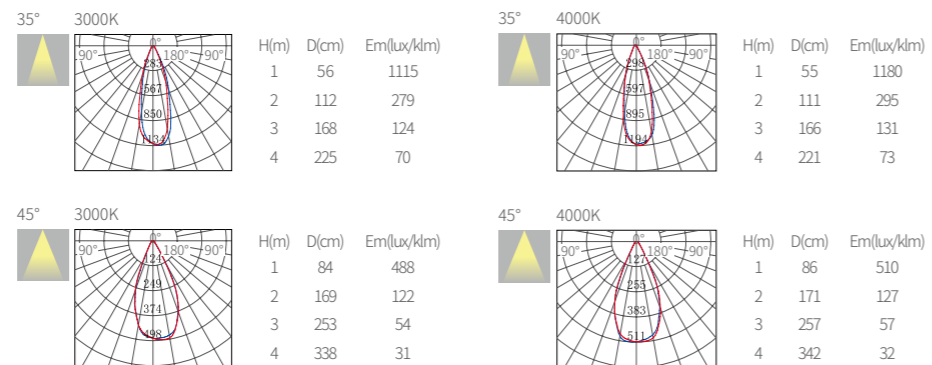

HDM6007G

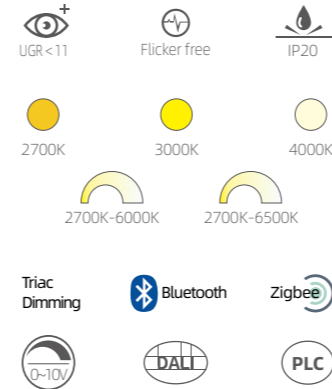

Product information

Power	7W
Beam angle	15°/24°/36°
Input voltage	AC 200-240V
Input frequency	50Hz
System Luminous flux	67Lm/w
CRI	Ra > 90/97
Finish color	Titanium

Product performance

Saturation red reduction degree	R9=90
Color Accuracy	Rf ≥ 92
Color Saturation	Rg=99
Color tolerance	SDCM < 3
Light Fixture Material	Aluminium
Installation	Recessed

Light distribution parameters

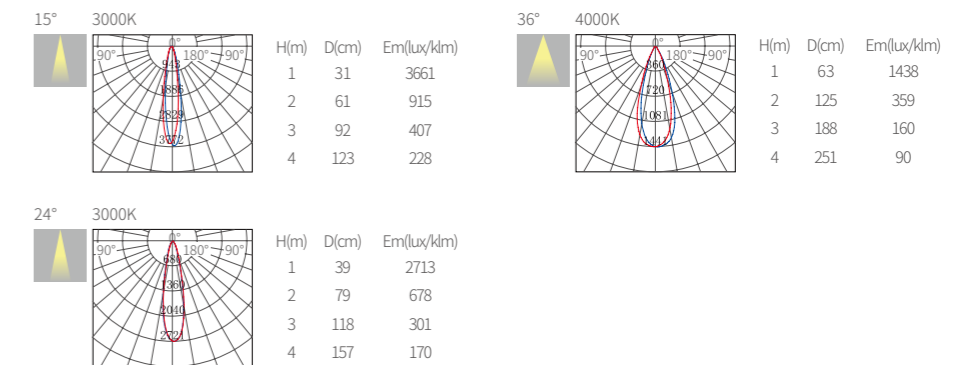

BULGARI RECESSED
DOWNLIGHT SERIES



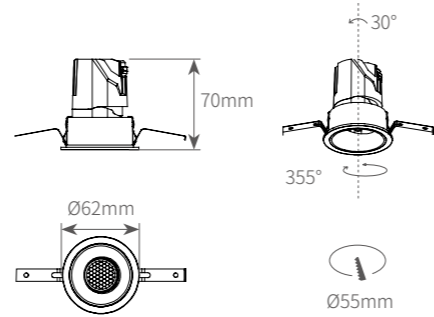

BDL5507

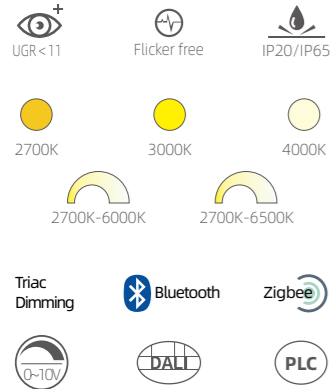

Product information

Power	7W
Beam angle	15°/24°/36°/50°
Input voltage	AC 200-240V
Input frequency	50Hz
System Luminous flux	67Lm/w
CRI	Ra > 90/97
Finish color	Titanium

Product performance

Saturation red reduction degree	R9=90
Color Accuracy	Rf ≥ 92
Color Saturation	Rg=99
Color tolerance	SDCM < 3
Light Fixture Material	Aluminium
Installation	Recessed

Light distribution parameters

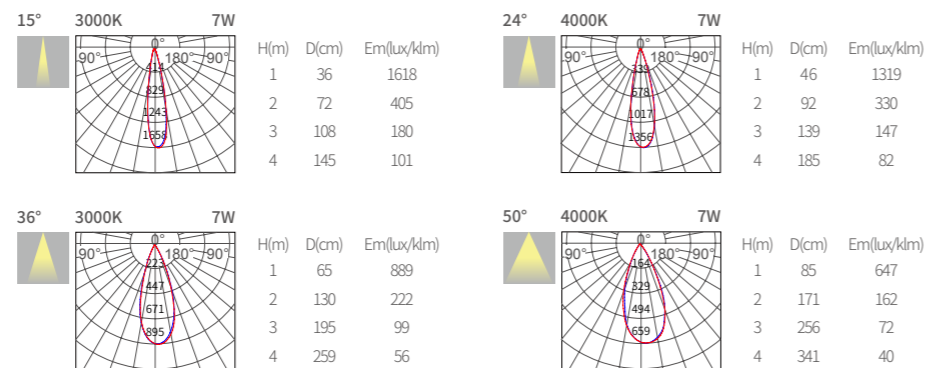

Optional anti glare cover color



Optional Accessories

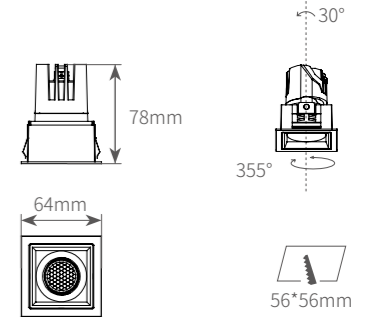
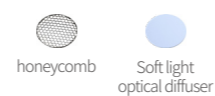

BDLS5507

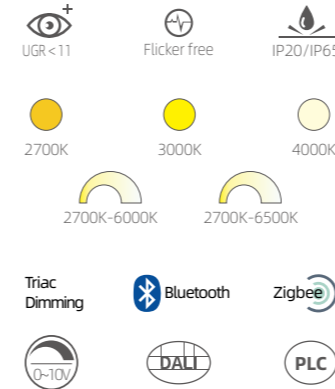

Product information

Power	7W
Beam angle	15°/24°/36°/50°
Input voltage	AC 200-240V
Input frequency	50Hz
System Luminous flux	67Lm/w
CRI	Ra > 90/97
Finish color	Titanium

Product performance

Saturation red reduction degree	R9=90
Color Accuracy	Rf ≥ 92
Color Saturation	Rg=99
Color tolerance	SDCM < 3
Light Fixture Material	Aluminium
Installation	Recessed

Light distribution parameters

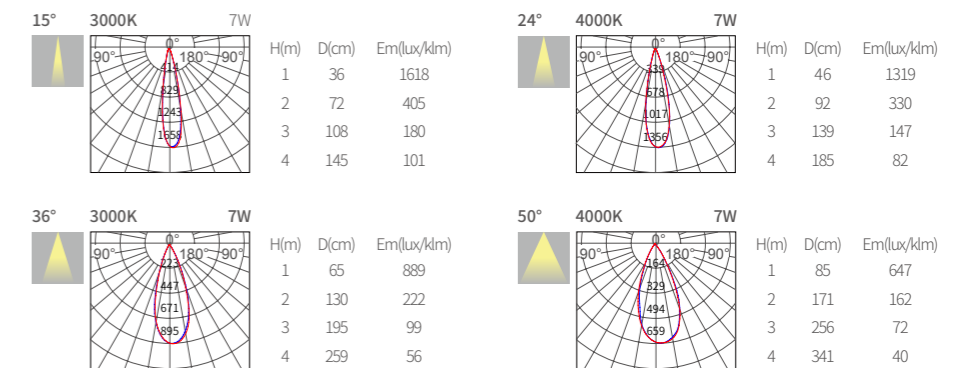

Optional anti glare cover color



Optional Accessories

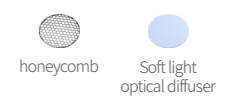

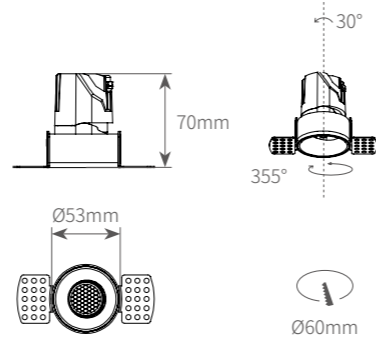

BDL5507-TR

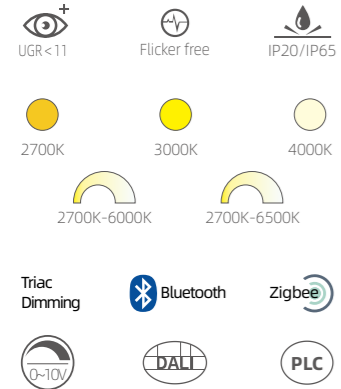

Product information

Power	7W
Beam angle	15°/24°/36°/50°
Input voltage	AC 200-240V
Input frequency	50Hz
System Luminous flux	67Lm/w
CRI	Ra>90/97
Finish color	Titanium

Product performance

Saturation red reduction degree	R9=90
Color Accuracy	Rf≥92
Color Saturation	Rg=99
Color tolerance	SDCM<3
Light Fixture Material	Aluminium
Installation	Recessed

Light distribution parameters

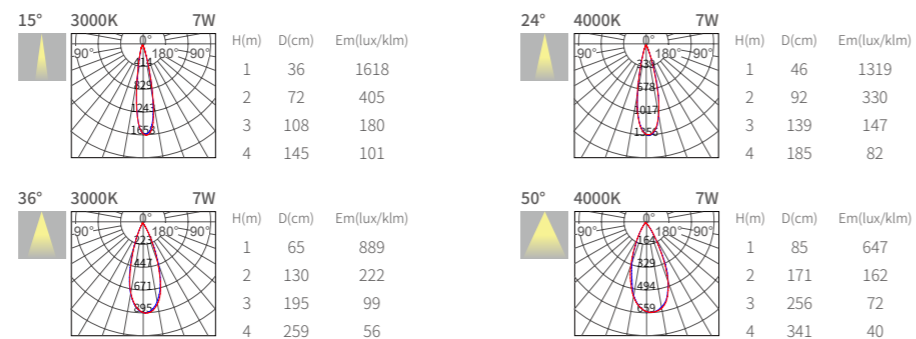

Optional anti glare cover color



Optional Accessories

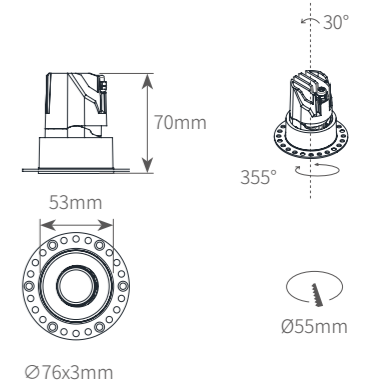
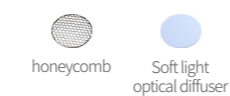

BDL5507-TR-B

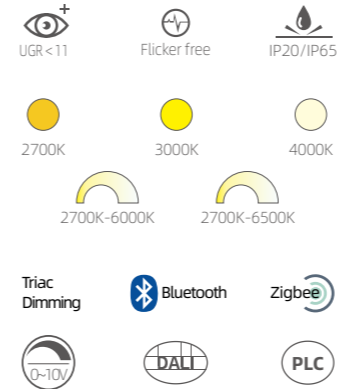

Product information

Power	7W
Beam angle	15°/24°/36°/50°
Input voltage	AC 200-240V
Input frequency	50Hz
System Luminous flux	67Lm/w
CRI	Ra>90/97
Finish color	Titanium

Product performance

Saturation red reduction degree	R9=90
Color Accuracy	Rf≥92
Color Saturation	Rg=99
Color tolerance	SDCM<3
Light Fixture Material	Aluminium
Installation	Recessed

Light distribution parameters

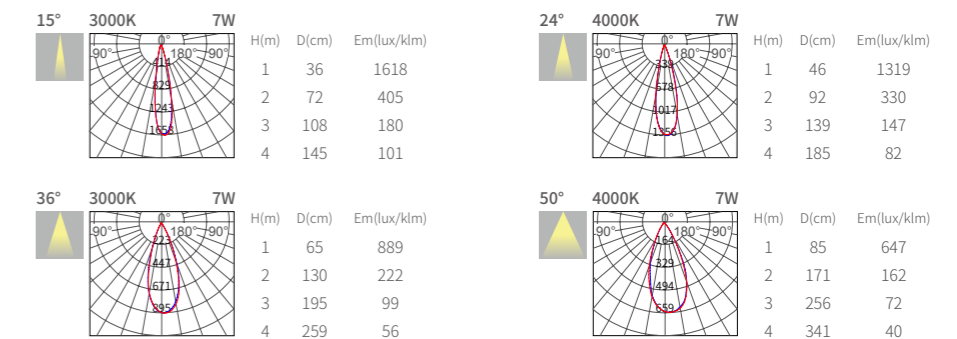

Optional anti glare cover color

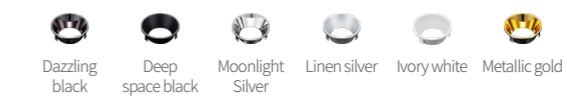

Optional Accessories



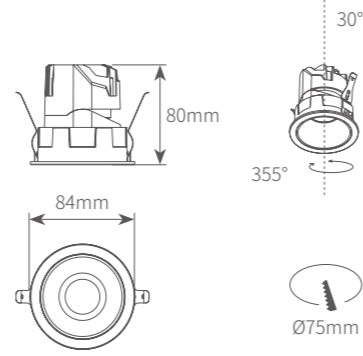

BDL7512

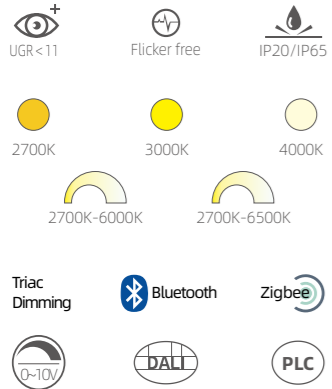

Product information

Power	12W
Beam angle	15°/24°/36°/50°
Input voltage	AC 200-240V
Input frequency	50Hz
System Luminous flux	67Lm/w
CRI	Ra > 90/97
Finish color	Titanium

Product performance

Saturation red reduction degree	R9=90
Color Accuracy	Rf ≥ 92
Color Saturation	Rg=99
Color tolerance	SDCM < 3
Light Fixture Material	Aluminium
Installation	Recessed

Light distribution parameters

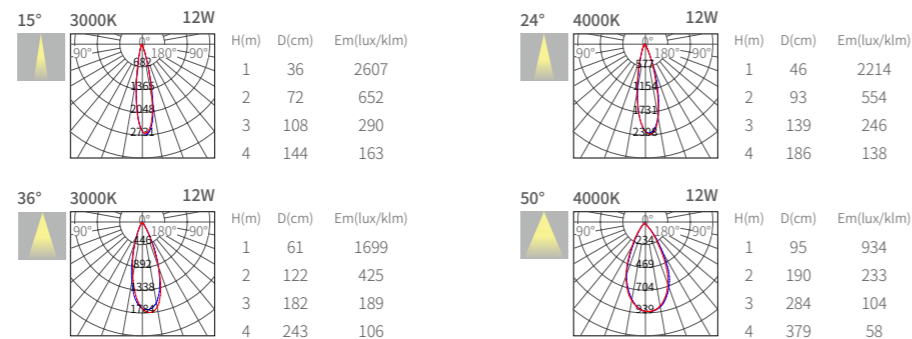

Optional anti glare cover color



Optional Accessories

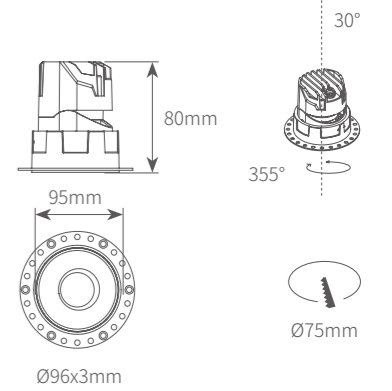
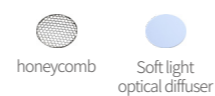

BDL7512-TR

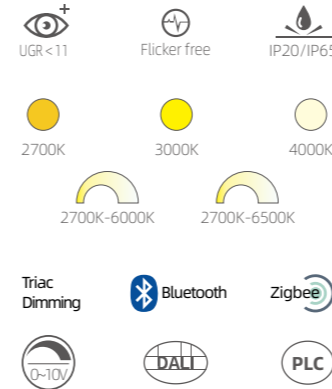

Product information

Power	12W
Beam angle	15°/24°/36°/50°
Input voltage	AC 200-240V
Input frequency	50Hz
System Luminous flux	67Lm/w
CRI	Ra > 90/97
Finish color	Titanium

Product performance

Saturation red reduction degree	R9=90
Color Accuracy	Rf ≥ 92
Color Saturation	Rg=99
Color tolerance	SDCM < 3
Light Fixture Material	Aluminium
Installation	Recessed

Light distribution parameters

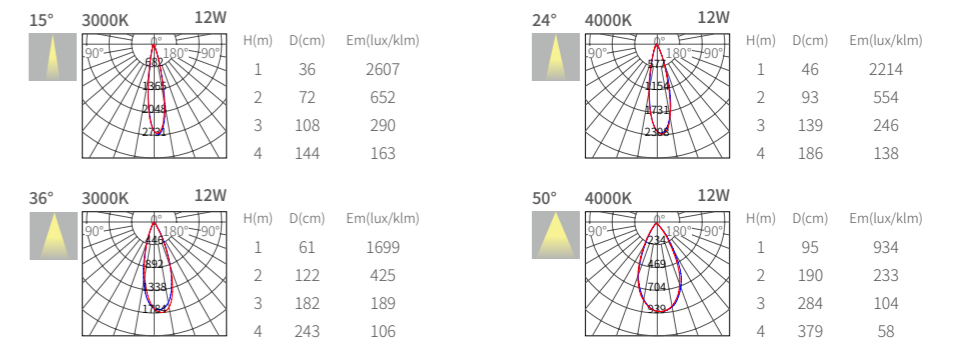

Optional anti glare cover color



Optional Accessories



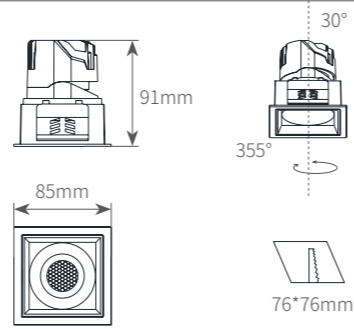

BDLS7512

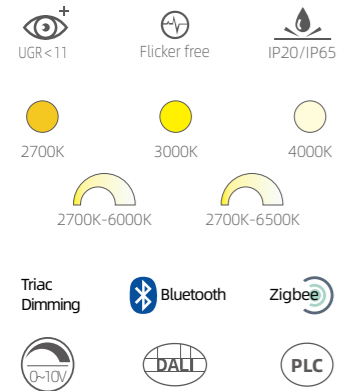

Product information

Power	12W
Beam angle	15°/24°/36°/50°
Input voltage	AC 200-240V
Input frequency	50Hz
System Luminous flux	67Lm/w
CRI	Ra > 90/97
Finish color	Titanium

Product performance

Saturation red reduction degree	R9=90
Color Accuracy	Rf ≥ 92
Color Saturation	Rg=99
Color tolerance	SDCM < 3
Light Fixture Material	Aluminium
Installation	Recessed

Light distribution parameters

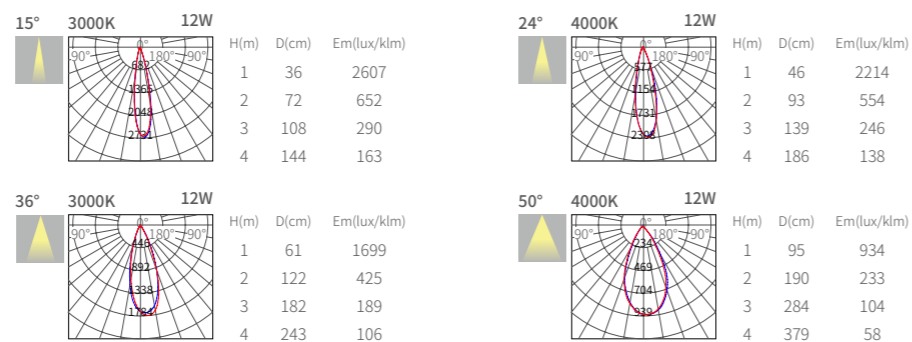

Optional anti glare cover color



Optional Accessories

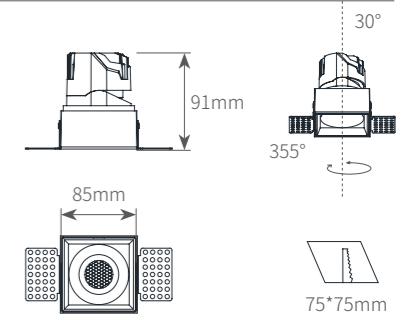

BDLS7512-TR

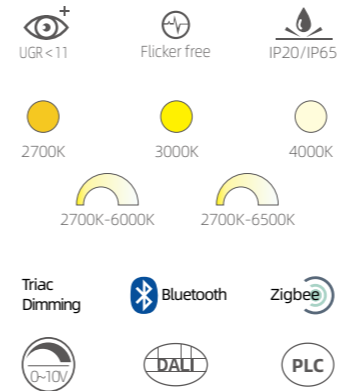

Product information

Power	12W
Beam angle	15°/24°/36°/50°
Input voltage	AC 200-240V
Input frequency	50Hz
System Luminous flux	67Lm/w
CRI	Ra > 90/97
Finish color	Titanium

Product performance

Saturation red reduction degree	R9=90
Color Accuracy	Rf ≥ 92
Color Saturation	Rg=99
Color tolerance	SDCM < 3
Light Fixture Material	Aluminium
Installation	Recessed

Light distribution parameters

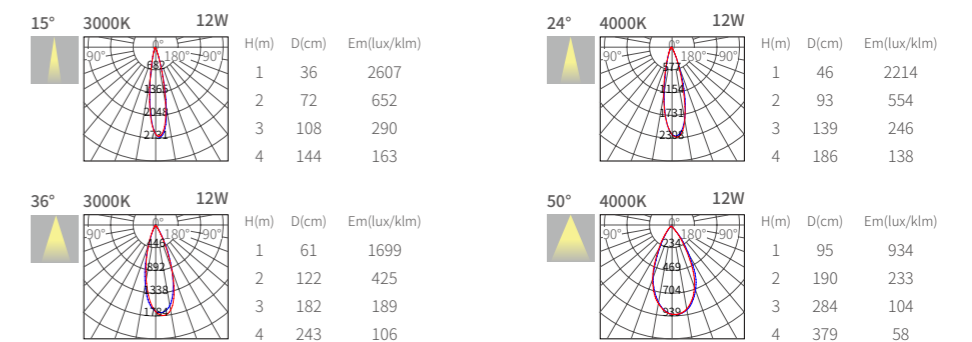

Optional anti glare cover color



Optional Accessories



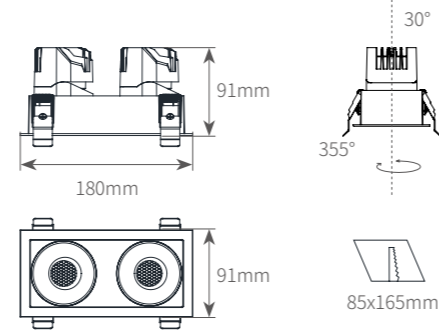
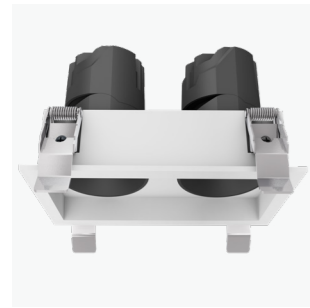

BDLS1507524

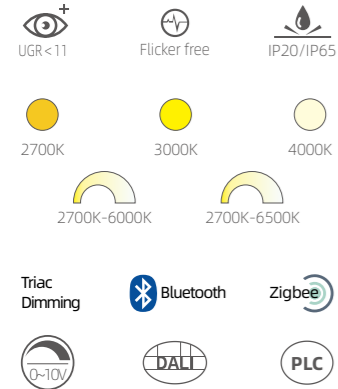

Product information

Power	12W*2
Beam angle	15° /24°/36°/ 50°
Input voltage	AC 200-240V
Input frequency	50Hz
System Luminous flux	67Lm/w
CRI	Ra>90/97
Finish color	Titanium

Product performance

Saturation red reduction degree	R9=90
Color Accuracy	Rf≥92
Color Saturation	Rg=99
Color tolerance	SDCM<3
Light Fixture Material	Aluminium
Installation	Recessed

Light distribution parameters

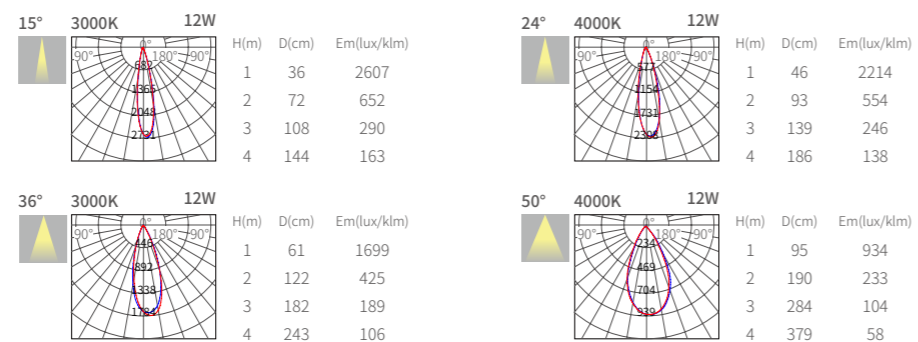

Optional anti glare cover color



Optional Accessories

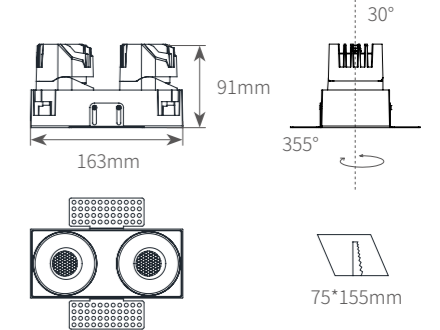

BDLS1507524-TR

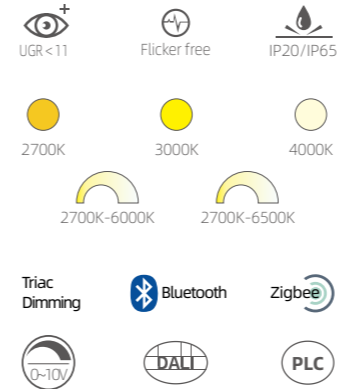

Product information

Power	12W*2
Beam angle	15° /24°/36°/ 50°
Input voltage	AC 200-240V
Input frequency	50Hz
System Luminous flux	67Lm/w
CRI	Ra>90/97
Finish color	Titanium

Product performance

Saturation red reduction degree	R9=90
Color Accuracy	Rf≥92
Color Saturation	Rg=99
Color tolerance	SDCM<3
Light Fixture Material	Aluminium
Installation	Recessed

Light distribution parameters

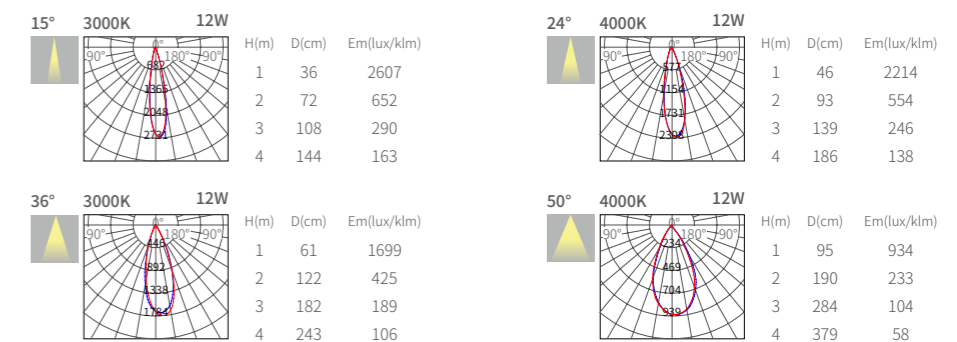

Optional anti glare cover color



Optional Accessories

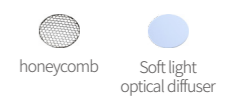

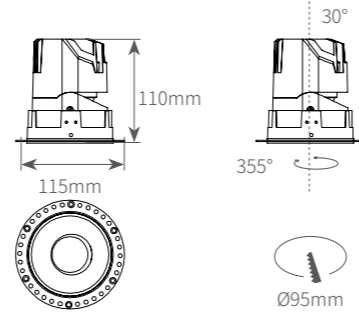

BDL9520-TR

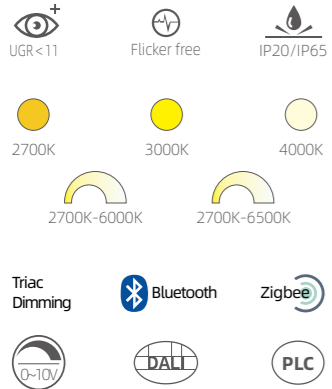

Product information

Power	20W
Beam angle	15° /24°/36°/ 50°
Input voltage	AC 200-240V
Input frequency	50Hz
System Luminous flux	67Lm/w
CRI	Ra>90/97
Finish color	Titanium

Product performance

Saturation red reduction degree	R9=90
Color Accuracy	Rf≥92
Color Saturation	Rg=99
Color tolerance	SDCM<3
Light Fixture Material	Aluminium
Installation	Recessed

Light distribution parameters

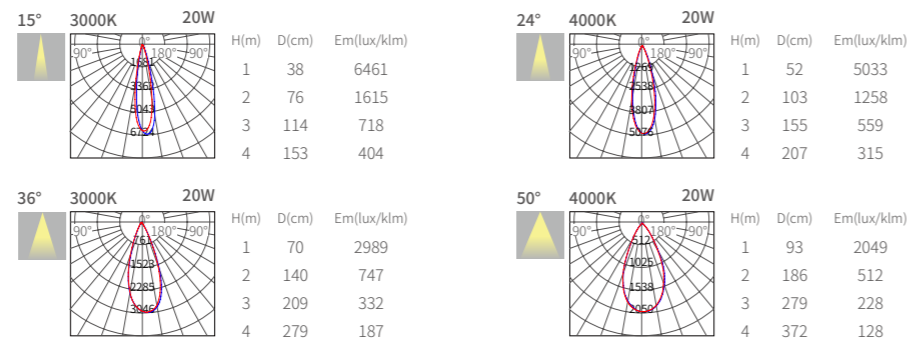

Optional anti glare cover color



Optional Accessories

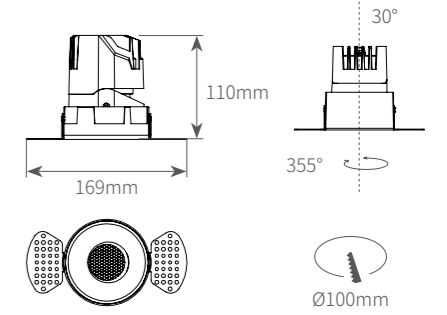
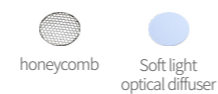

BDLS9520-TR

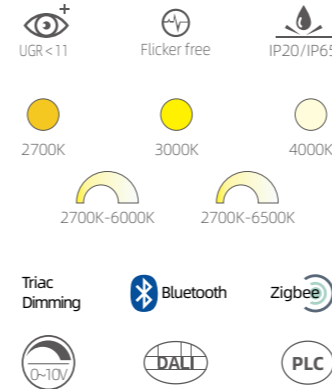

Product information

Power	20W
Beam angle	15° /24°/36°/ 50°
Input voltage	AC 200-240V
Input frequency	50Hz
System Luminous flux	67Lm/w
CRI	Ra>90/97
Finish color	Titanium

Product performance

Saturation red reduction degree	R9=90
Color Accuracy	Rf≥92
Color Saturation	Rg=99
Color tolerance	SDCM<3
Light Fixture Material	Aluminium
Installation	Recessed

Light distribution parameters

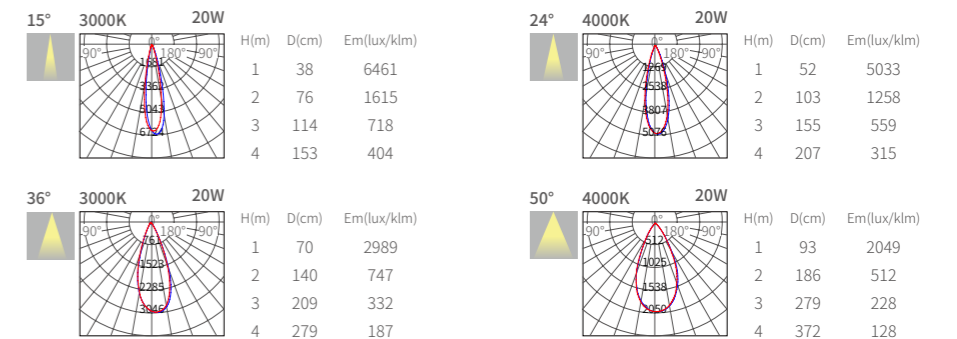

Optional anti glare cover color



Optional Accessories

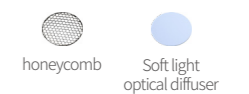

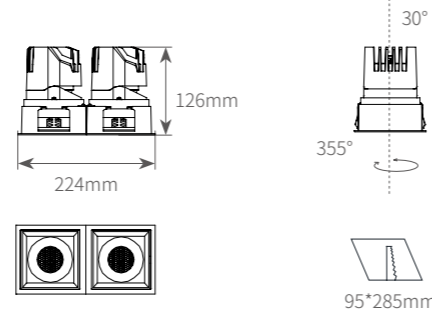

BDLS19095

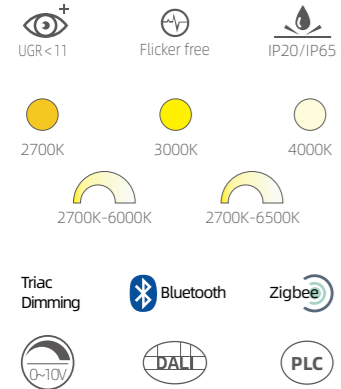

Product information

Power	20W*2
Beam angle	15° /24°/36°/ 50°
Input voltage	AC 200-240V
Input frequency	50Hz
System Luminous flux	67Lm/w
CRI	Ra>90/97
Finish color	Titanium

Product performance

Saturation red reduction degree	R9=90
Color Accuracy	Rf≥92
Color Saturation	Rg=99
Color tolerance	SDCM<3
Light Fixture Material	Aluminium
Installation	Recessed

Light distribution parameters

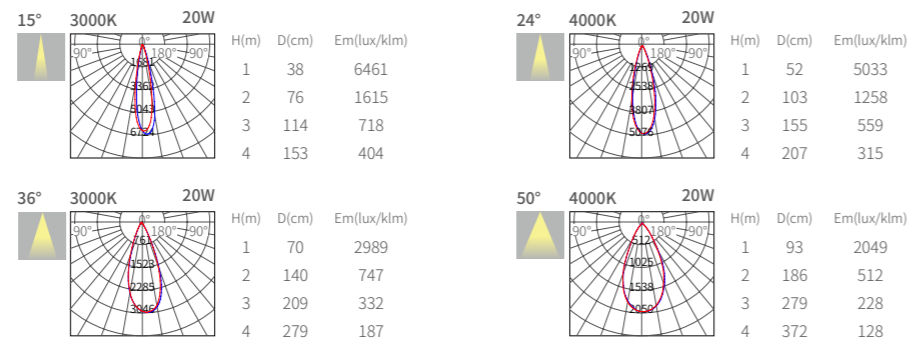

Optional anti glare cover color



Optional Accessories

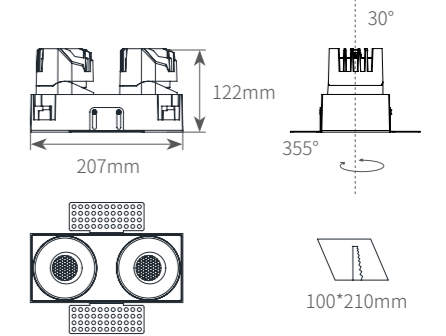
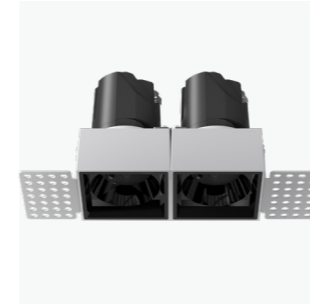
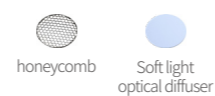

BDLS19095-TR

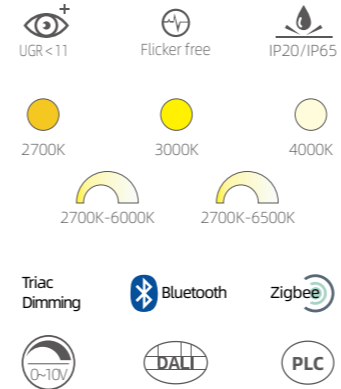

Product information

Power	20W*2
Beam angle	15° /24°/36°/ 50°
Input voltage	AC 200-240V
Input frequency	50Hz
System Luminous flux	67Lm/w
CRI	Ra>90/97
Finish color	Titanium

Product performance

Saturation red reduction degree	R9=90
Color Accuracy	Rf≥92
Color Saturation	Rg=99
Color tolerance	SDCM<3
Light Fixture Material	Aluminium
Installation	Recessed

Light distribution parameters

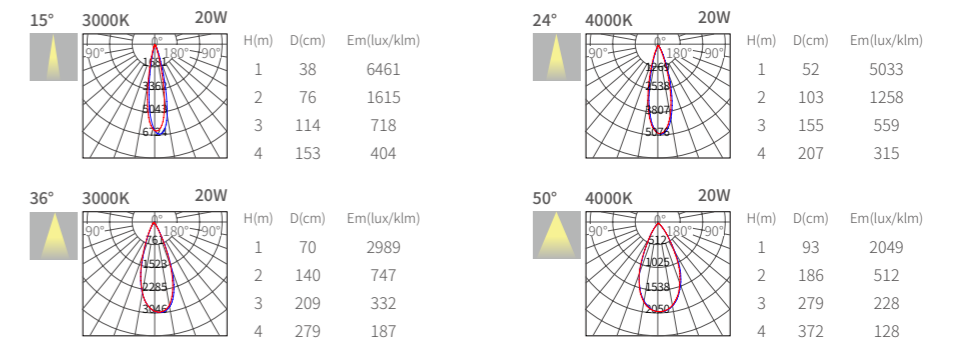

Optional anti glare cover color



Optional Accessories

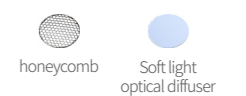

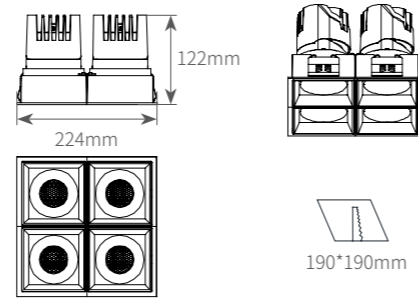

BDLS11011028-TR

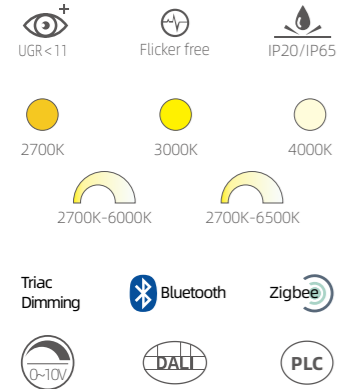

Product information

Power	20W*4
Beam angle	15° /24°/36°/ 50°
Input voltage	AC 200-240V
Input frequency	50Hz
System Luminous flux	67Lm/w
CRI	Ra>90/97
Finish color	Titanium

Product performance

Saturation red reduction degree	R9=90
Color Accuracy	Rf≥92
Color Saturation	Rg=99
Color tolerance	SDCM<3
Light Fixture Material	Aluminium
Installation	Recessed

Light distribution parameters

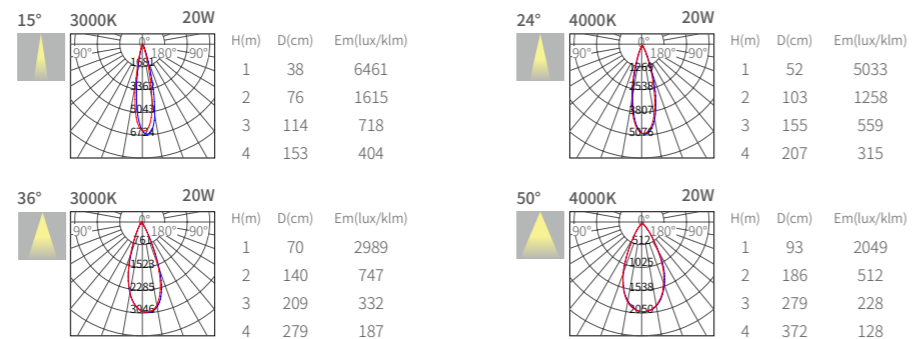

Optional anti glare cover color



Optional Accessories

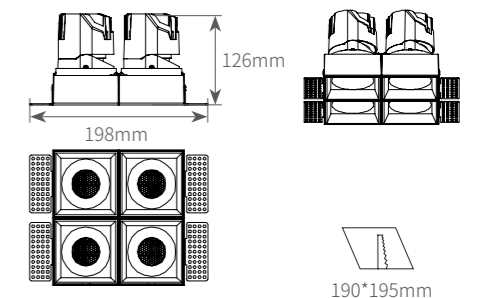
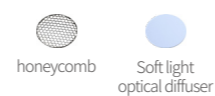

BDLS11011028-TR

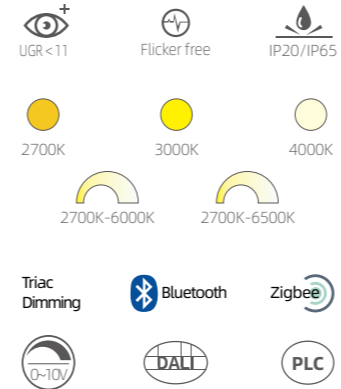

Product information

Power	20W*4
Beam angle	15° /24°/36°/ 50°
Input voltage	AC 200-240V
Input frequency	50Hz
System Luminous flux	67Lm/w
CRI	Ra>90/97
Finish color	Titanium

Product performance

Saturation red reduction degree	R9=90
Color Accuracy	Rf≥92
Color Saturation	Rg=99
Color tolerance	SDCM<3
Light Fixture Material	Aluminium
Installation	Recessed

Light distribution parameters

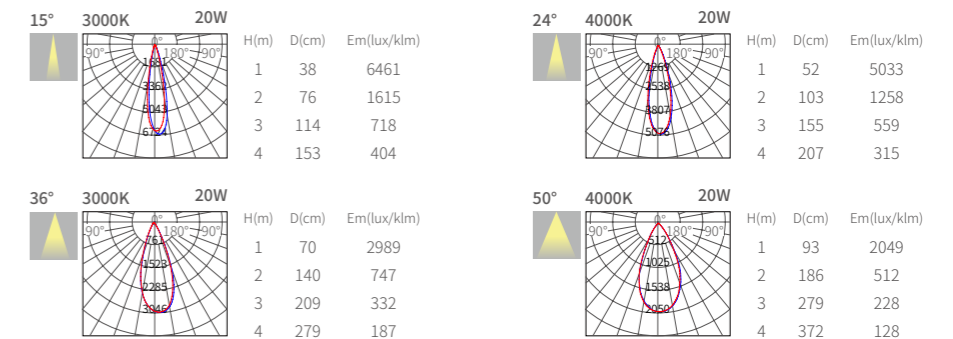

Optional anti glare cover color



Optional Accessories

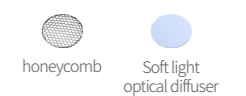

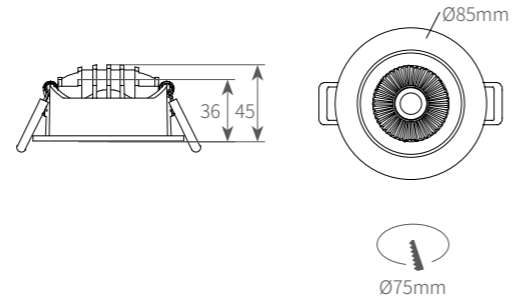

MGM7507-A

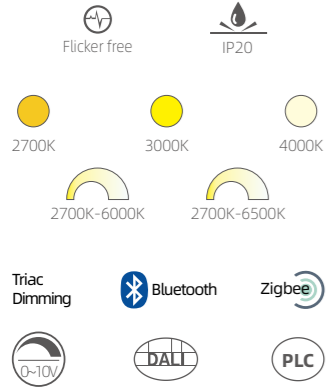

Product information

Power	7W
Beam angle	24°/36°
Input voltage	AC 200-240V
Input frequency	50Hz
System Luminous flux	95lm/W
CRI	Ra>92
Finish color	Ivory white

Product performance

Saturation red reduction degree	R9=90
Color Accuracy	Rf≥92
Color Saturation	Rg=99
Color tolerance	SDCM<3
Light Fixture Material	die-casting aluminum
Installation	Recessed

Light distribution parameters

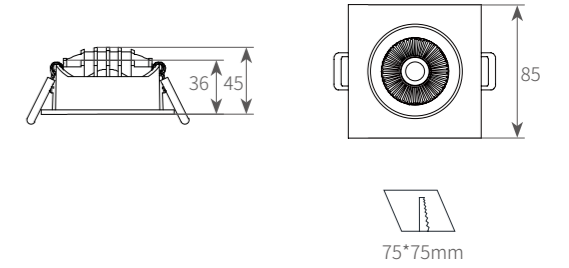
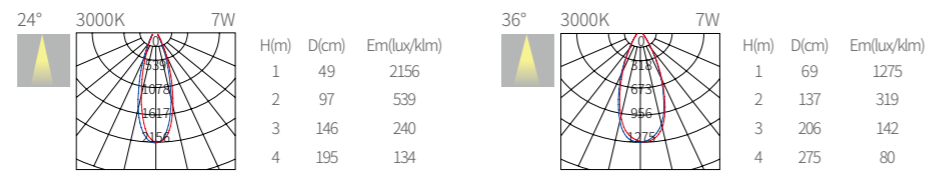

MGMS7507-A

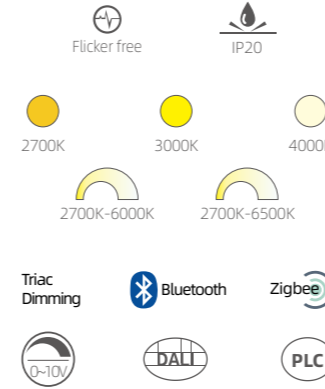

Product information

Power	7W
Beam angle	24°/36°
Input voltage	AC 200-240V
Input frequency	50Hz
System Luminous flux	95lm/W
CRI	Ra>92
Finish color	Ivory white

Product performance

Saturation red reduction degree	R9=90
Color Accuracy	Rf≥92
Color Saturation	Rg=99
Color tolerance	SDCM<3
Light Fixture Material	die-casting aluminum
Installation	Recessed

Light distribution parameters

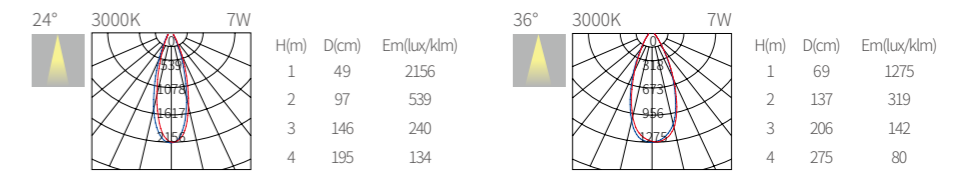

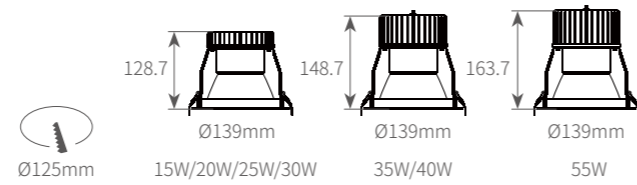

DLC04-A

Product information

Power	15/20/25/30/35/40/55W
Beam angle	30°
Input voltage	AC100-240/220-240V
Input frequency	50/60Hz
System Luminous flux	94lm/W
CRI	Ra>90
Finish color	white/black

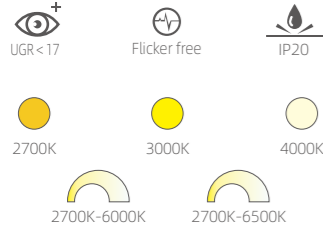

Mode

DLC0415A-930XY	15W	DLC0430A-930XY	30W	DLC0455A-930XY	55W
DLC0415A-940XY		DLC0430A-940XY		DLC0455A-940XY	
DLC0420A-930XY	20W	DLC0435A-930XY	35W		
DLC0420A-940XY		DLC0435A-940XY			
DLC0425A-930XY	25W	DLC0440A-930XY	40W		
DLC0425A-940XY		DLC0440A-940XY			

Light distribution parameters

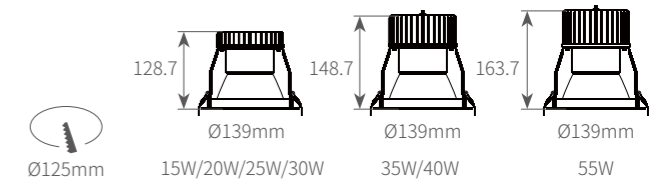
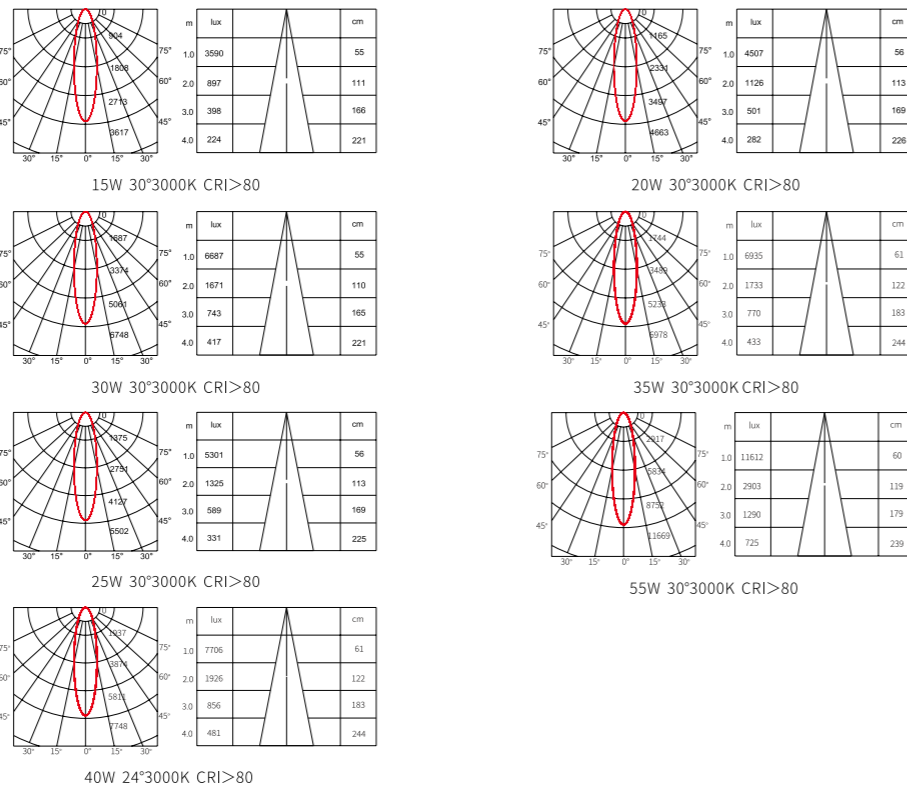

DLC04-B

Product information

Power	15/20/25/30/35/40/55W
Beam angle	15°/24°/36°/50°
Input voltage	AC100-240/220-240V
Input frequency	50/60Hz
System Luminous flux	99lm/W
CRI	Ra>90
Finish color	white/black

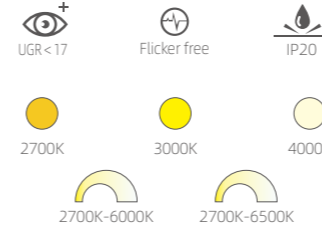

Mode

DLC0415B-930XY	15W	DLC0430B-930XY	30W	DLC0455B-930XY	55W
DLC0415B-940XY		DLC0430B-940XY		DLC0455B-940XY	
DLC0420B-930XY	20W	DLC0435B-930XY	35W		
DLC0420B-940XY		DLC0435B-940XY			
DLC0425B-930XY	25W	DLC0440B-930XY	40W		
DLC0425B-940XY		DLC0440B-940XY			

Light distribution parameters

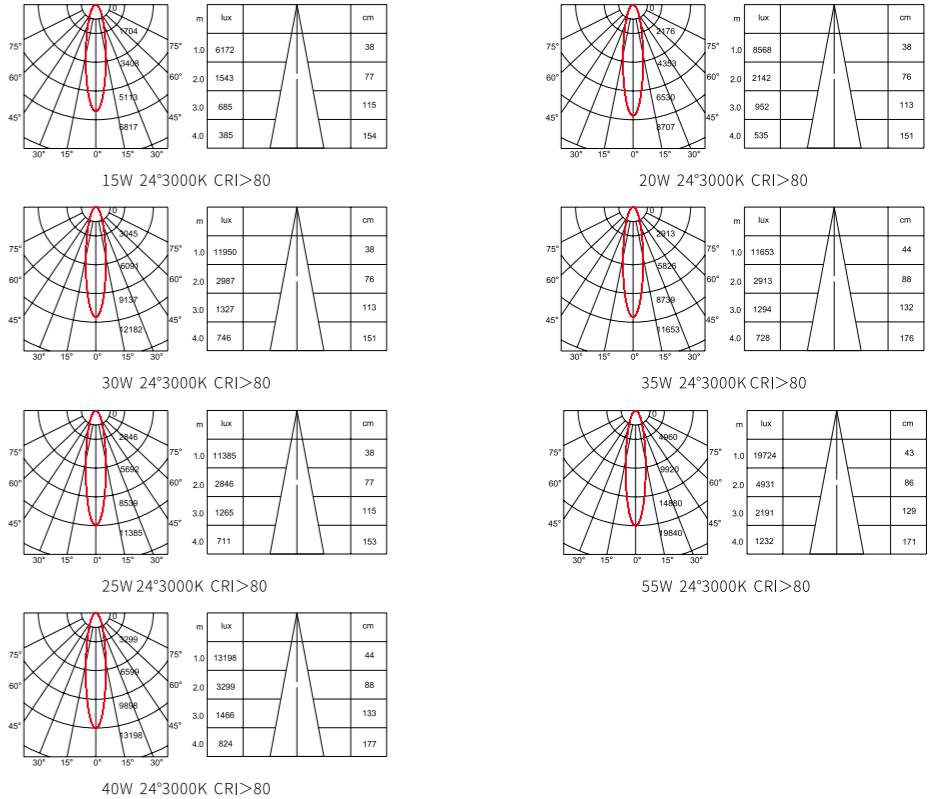

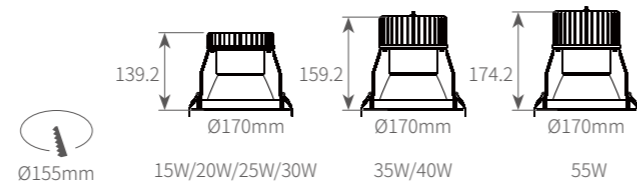

DLC05-A

Product information

Power	15/20/25/30/35/40/55W
Beam angle	45°
Input voltage	AC100-240/220-240V
Input frequency	50/60Hz
System Luminous flux	105lm/W
CRI	Ra>90
Finish color	white/black

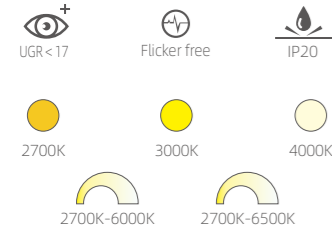

Mode

DLC0515A-930XY	15W	DLC0530A-930XY	30W	DLC0555A-930XY	55W
DLC0515A-940XY		DLC0530A-940XY		DLC0555A-940XY	
DLC0520A-930XY	20W	DLC0535A-930XY	35W		
DLC0520A-940XY		DLC0535A-940XY			
DLC0525A-930XY	25W	DLC0540A-930XY	40W		
DLC0525A-940XY		DLC0540A-940XY			

Light distribution parameters

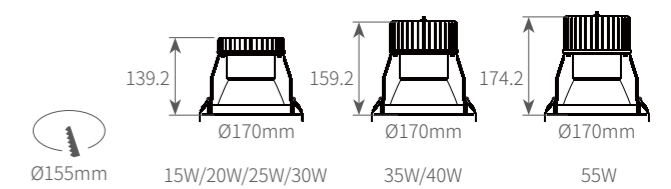
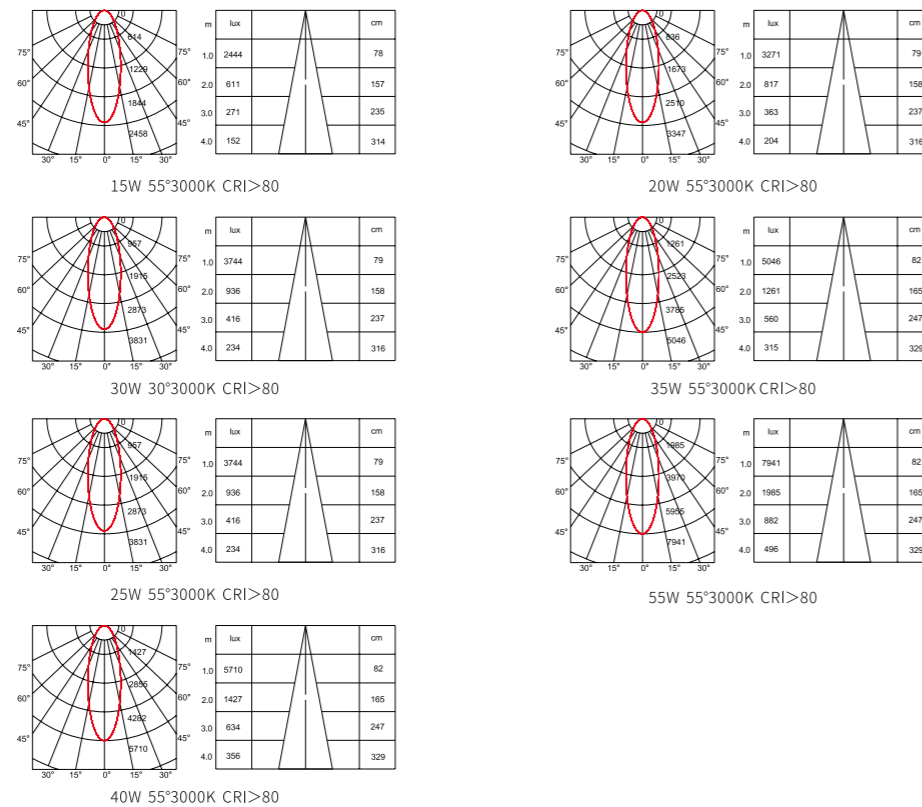

DLC05-B

Product information

Power	15/20/25/30/35/40/55W
Beam angle	15°/24°/36°/55°
Input voltage	AC100-240/220-240V
Input frequency	50/60Hz
System Luminous flux	115lm/W
CRI	Ra>90
Finish color	white/black

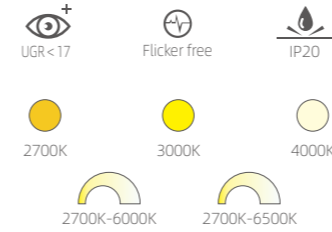

Mode

DLC0515B-930XY	15W	DLC0530B-930XY	30W	DLC0555B-930XY	55W
DLC0515B-940XY		DLC0530B-940XY		DLC0555B-940XY	
DLC0520B-930XY	20W	DLC0535B-930XY	35W		
DLC0520B-940XY		DLC0535B-940XY			
DLC0525B-930XY	25W	DLC0540B-930XY	40W		
DLC0525B-940XY		DLC0540B-940XY			

Light distribution parameters

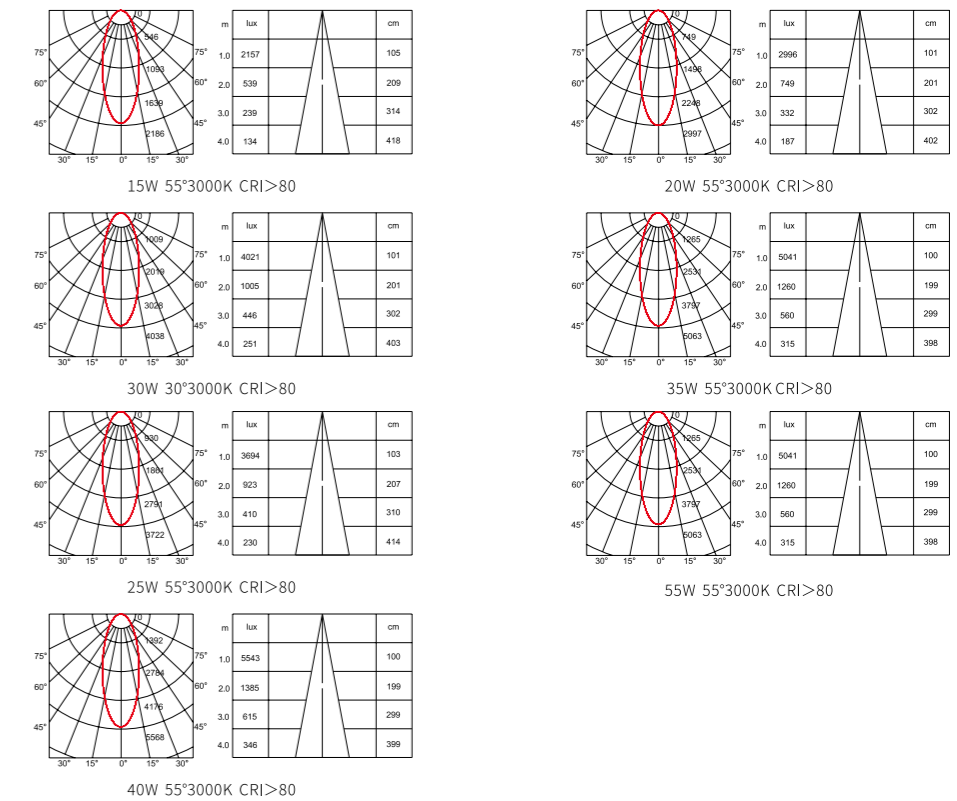

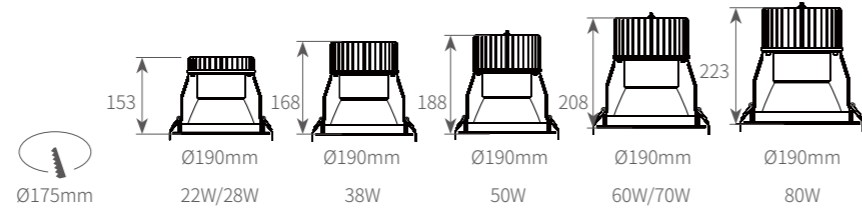

DLC06-A

Product information

Power	22W/28W/38W/50W/60W/70W/80W
Beam angle	30°
Input voltage	AC100-240/220-240V
Input frequency	50/60Hz
System Luminous flux	109lm/W
CRI	Ra>90
Finish color	white/black

Mode

DLC0622A-930XY	22W	DLC0650A-930XY	50W	DLC0680A-930XY	80W
DLC0628A-930XY	28W	DLC0660A-930XY	60W	DLC0670A-930XY	70W
DLC0638A-930XY	38W				
DLC0638A-930XY					

Light distribution parameters

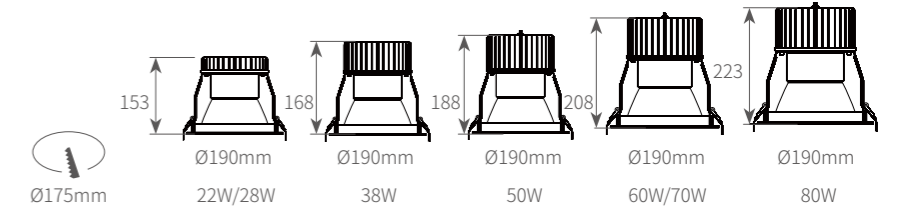
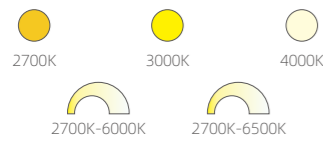
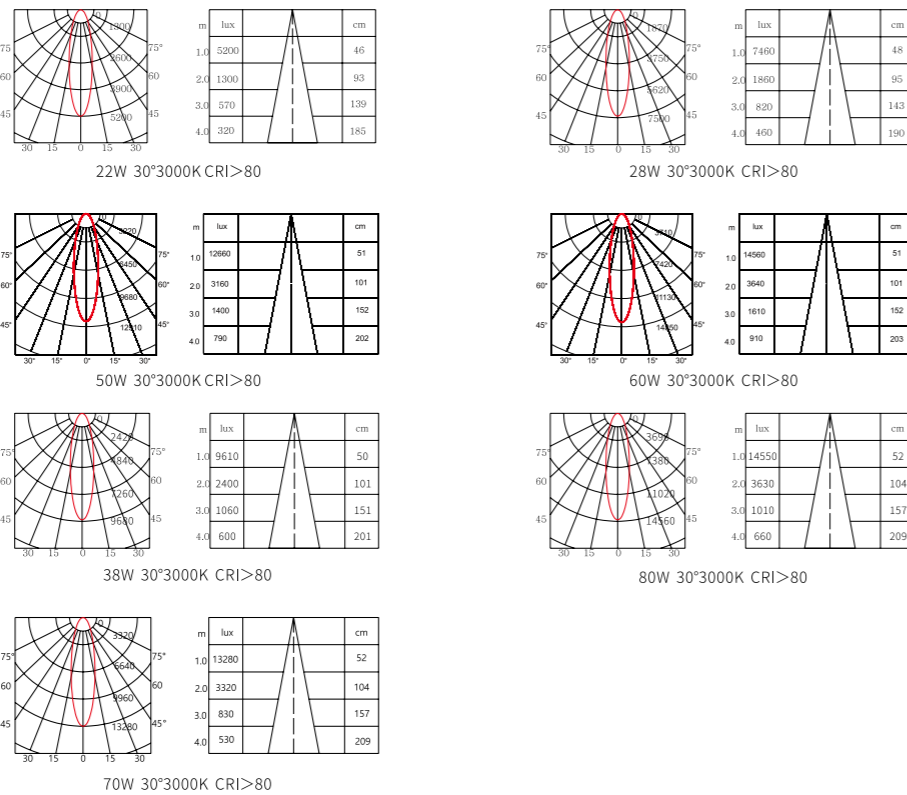

DLC06-B

Product information

Power	22W/28W/38W/50W/60W/70W/80W
Beam angle	25°/32°/45°/50°
Input voltage	AC100-240/220-240V
Input frequency	50/60Hz
System Luminous flux	122lm/W
CRI	Ra>90
Finish color	white/black

Mode

DLC0622B-930XY	22W	DLC0650B-930XY	50W	DLC0680B-930XY	80W
DLC0628B-930XY	28W	DLC0660B-930XY	60W	DLC0670B-930XY	70W
DLC0638B-930XY	38W				
DLC0638B-930XY					

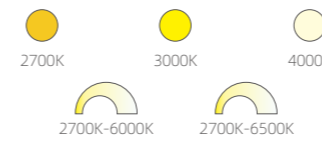

Light distribution parameters

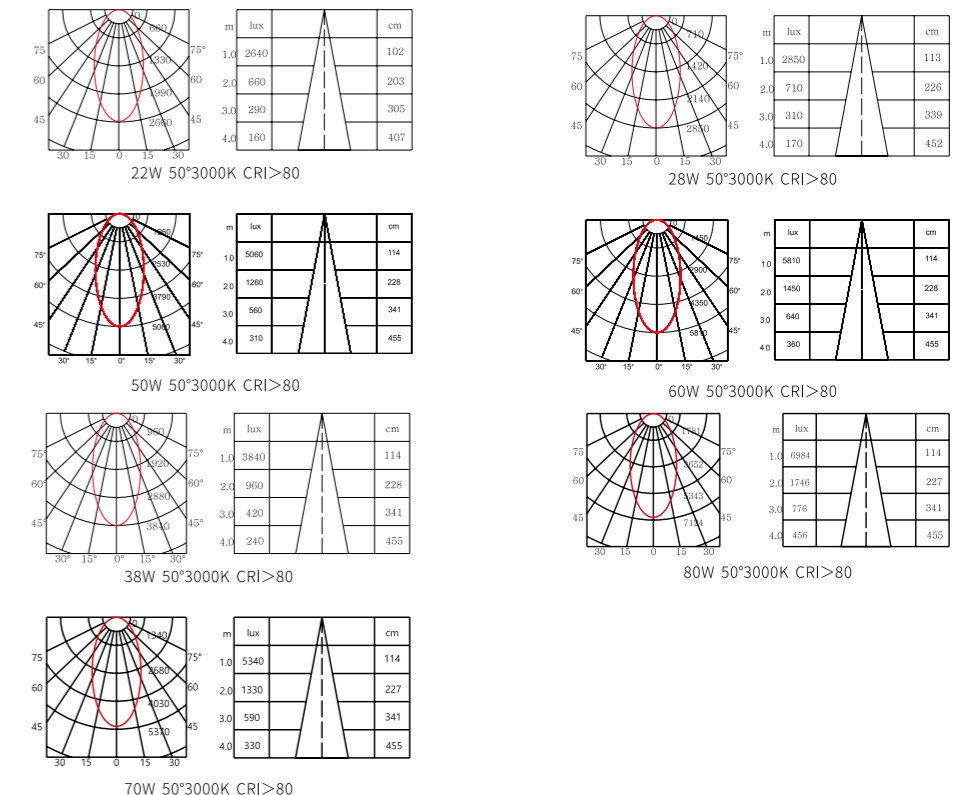

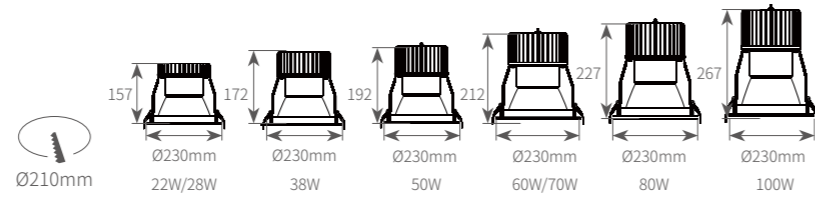

DLC08-A

Product information

Power	22W/28W/38W/50W/60W/70W/80W/100W
Beam angle	45°
Input voltage	AC100-240/220-240V
Input frequency	50/60Hz
System Luminous flux	115lm/W
CRI	Ra>90
Finish color	white/black

Mode

DLC0822A-930XY	22W	DLC0850A-930XY	50W	DLC0880A-930XY	80W
DLC0822A-940XY		DLC0850A-940XY		DLC0880A-940XY	
DLC0828A-930XY	28W	DLC0860A-930XY	60W	DLC08100A-930XY	100W
DLC0828A-940XY		DLC0860A-940XY		DLC08100A-940XY	
DLC0838A-930XY	38W	DLC0870A-930XY	70W		
DLC0838A-940XY		DLC0870A-940XY			

Light distribution parameters

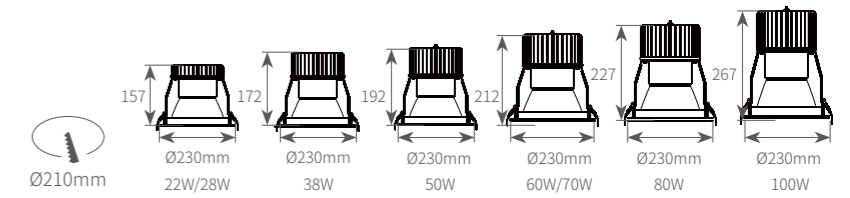
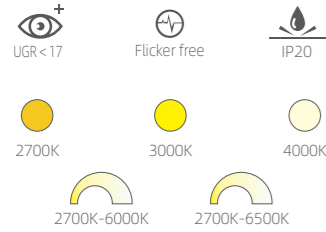
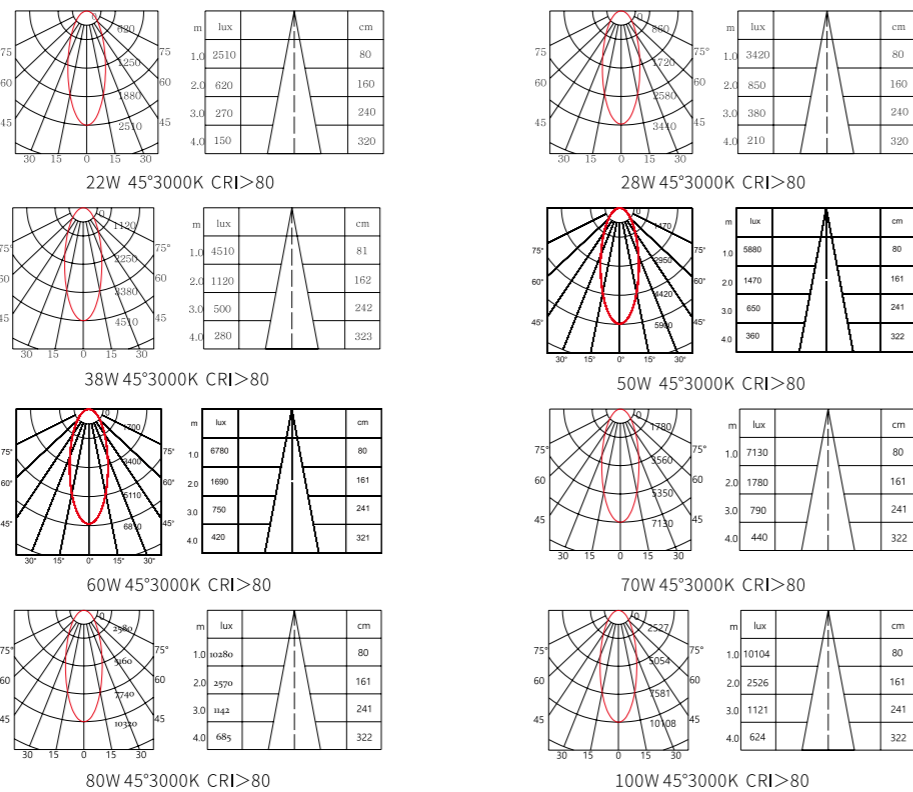

DLC08-B

Product information

Power	22W/28W/38W/50W/60W/70W/80W/100W
Beam angle	25°/36°/45°/55°
Input voltage	AC100-240/220-240V
Input frequency	50/60Hz
System Luminous flux	100lm/W
CRI	Ra>90
Finish color	white/black

Mode

DLC0822B-930XY	22W	DLC0850B-930XY	50W	DLC0880B-930XY	80W
DLC0822B-940XY		DLC0850B-940XY		DLC0880B-940XY	
DLC0828B-930XY	28W	DLC0860B-930XY	60W	DLC08100B-930XY	100W
DLC0828B-940XY		DLC0860B-940XY		DLC08100B-940XY	
DLC0838B-930XY	38W	DLC0870B-930XY	70W		
DLC0838B-940XY		DLC0870B-940XY			

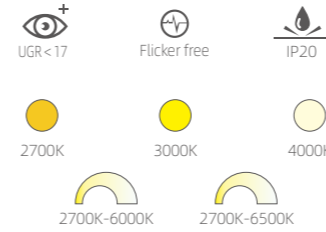

Light distribution parameters

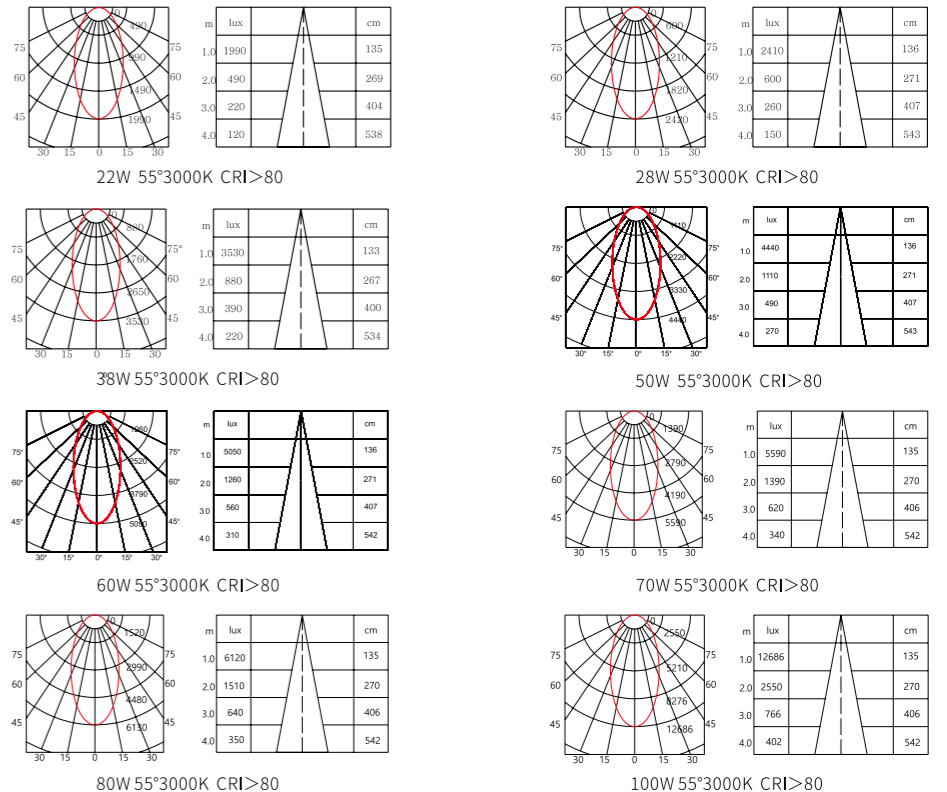

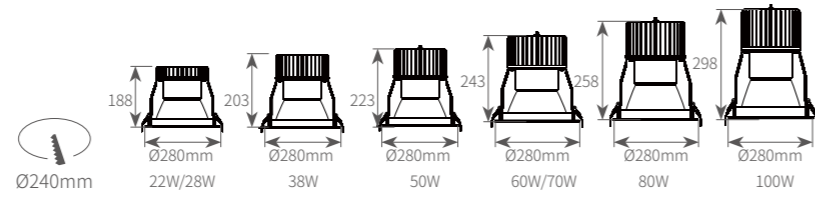

DLC10-A

Product information

Power	22W/28W/38W/50W/60W/70W/80W/100W
Beam angle	36°
Input voltage	AC100-240/220-240V
Input frequency	50/60Hz
System Luminous flux	94lm/W
CRI	Ra>90
Finish color	white/black

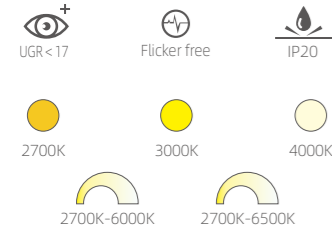

Mode

DLC1022A-930XY	22W	DLC1050A-930XY	50W	DLC1080A-930XY	80W
DLC1022A-940XY		DLC1050A-940XY		DLC1080A-940XY	
DLC1028A-930XY	28W	DLC1060A-930XY	60W	DLC10100A-930XY	100W
DLC1028A-940XY		DLC1060A-940XY		DLC10100A-940XY	
DLC1038A-930XY	38W	DLC1070A-930XY	70W		
DLC1038A-940XY		DLC1070A-940XY			

Light distribution parameters

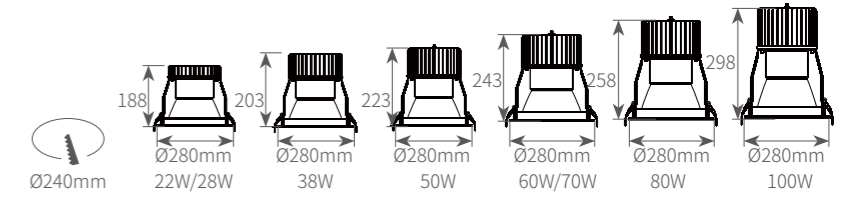
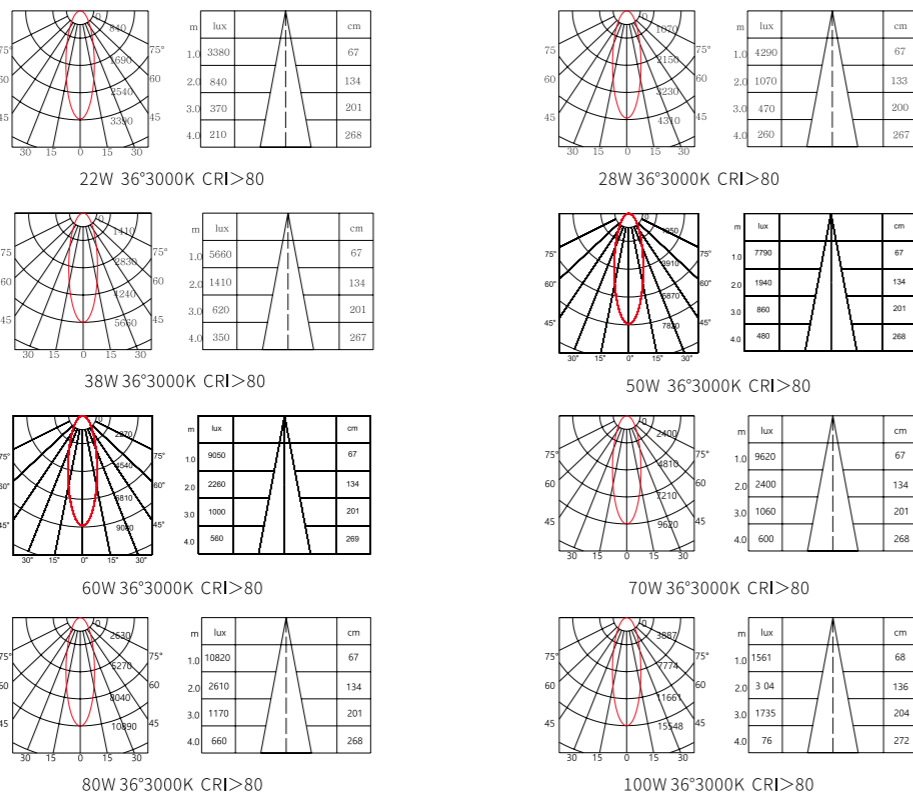

DLC10-B

Product information

Power	22W/28W/38W/50W/60W/70W/80W/100W
Beam angle	25°/32°/40°
Input voltage	AC100-240/220-240V
Input frequency	50/60Hz
System Luminous flux	104lm/W
CRI	Ra>90
Finish color	white/black

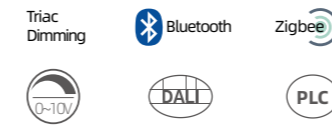
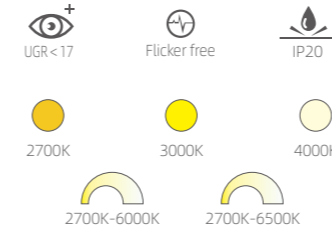

Mode

DLC1022B-930XY	22W	DLC1050B-930XY	50W	DLC1080B-930XY	80W
DLC1022B-940XY		DLC1050B-940XY		DLC1080B-940XY	
DLC1028B-930XY	28W	DLC1060B-930XY	60W	DLC10100B-930XY	100W
DLC1028B-940XY		DLC1060B-940XY		DLC10100B-940XY	
DLC1038B-930XY	38W	DLC1070B-930XY	70W		
DLC1038B-940XY		DLC1070B-940XY			

Light distribution parameters

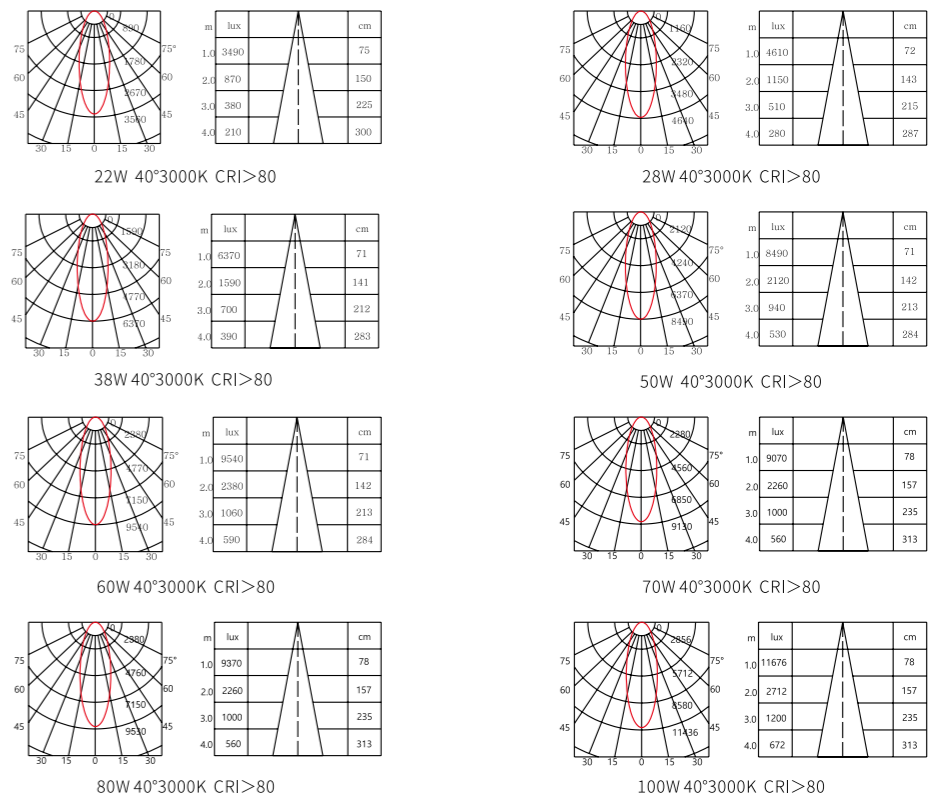

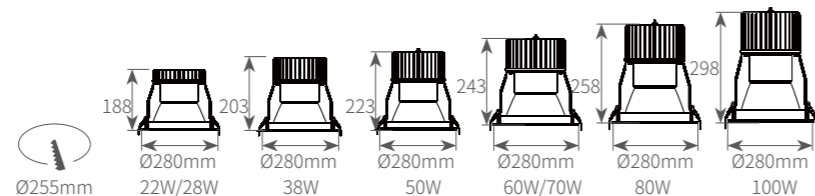

DLC10-D

Product information

Power	22W/28W/38W/50W/60W/70W/80W/100W
Beam angle	25°/45°/80°
Input voltage	AC100-240/220-240V
Input frequency	50/60Hz
System Luminous flux	110lm/W
CRI	Ra>90
Finish color	white/black

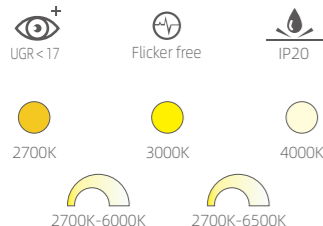

Mode

DLC1022D-930XY	22W	DLC1050D-930XY	50W	DLC1080D-930XY	80W
DLC1022D-940XY		DLC1050D-940XY		DLC1080D-940XY	
DLC1028D-930XY	28W	DLC1060D-930XY	60W	DLC10100D-930XY	100W
DLC1028D-940XY		DLC1060D-940XY		DLC10100D-940XY	
DLC1038D-930XY	38W	DLC1070D-930XY	70W		
DLC1038D-940XY		DLC1070D-940XY			

Light distribution parameters

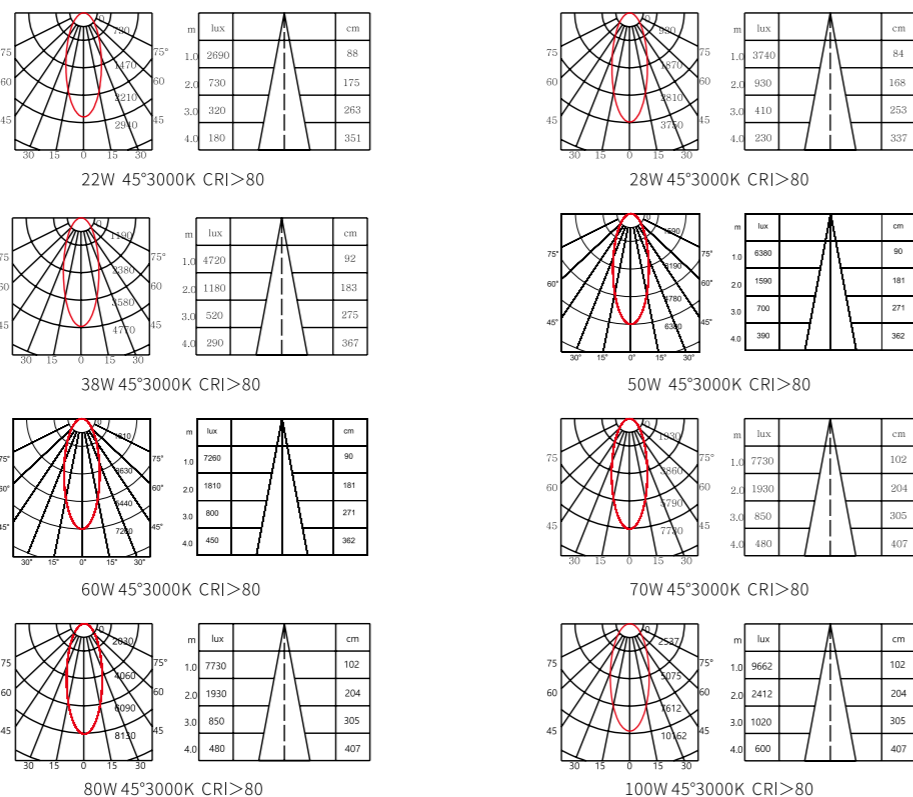

DLD RECESSED DOWNLIGHT
SERIES



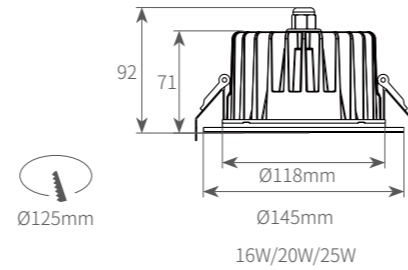

DLD04-A

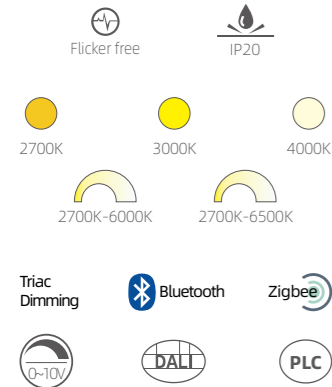

Product information

Power	16W/20W/25W
Beam angle	87°
Input voltage	AC100-240/220-240V
Input frequency	50/60Hz
System Luminous flux	96lm/W
CRI	Ra>90
Finish color	white/black

Mode

DLD0416A-930XY	16W
DLD0416A-940XY	16W
DLD0420A-930XY	20W
DLD0420A-940XY	20W
DLD0425A-930XY	25W
DLD0425A-940XY	25W

Light distribution parameters

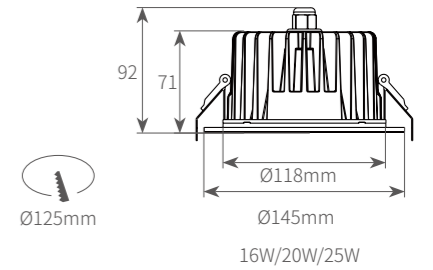
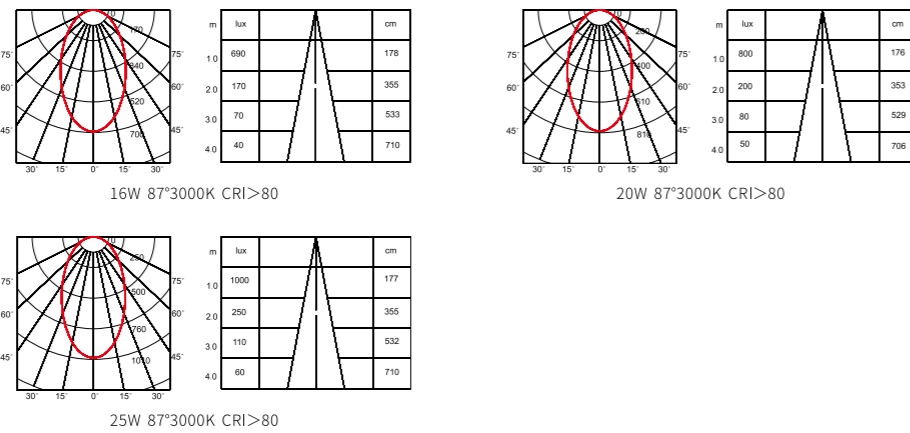

DLD04-B

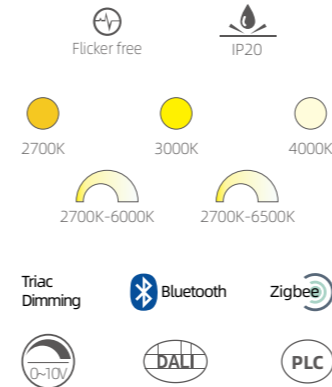

Product information

Power	16W/20W/25W
Beam angle	84°
Input voltage	AC100-240/220-240V
Input frequency	50/60Hz
System Luminous flux	89lm/W
CRI	Ra>90
Finish color	white/black

Mode

DLD0416B-930XY	16W
DLD0416B-940XY	16W
DLD0420B-930XY	20W
DLD0420B-940XY	20W
DLD0425B-930XY	25W
DLD0425B-940XY	25W

Light distribution parameters

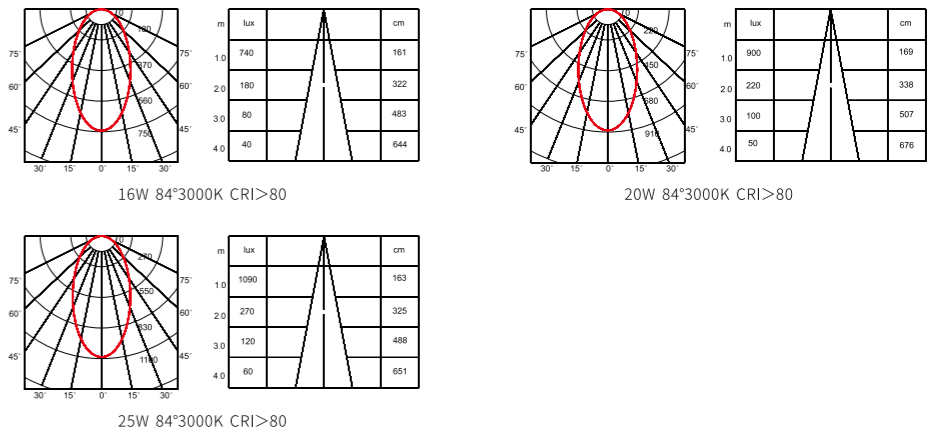

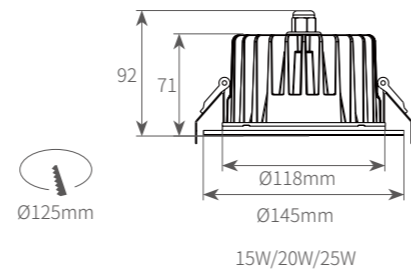

DLD04-C

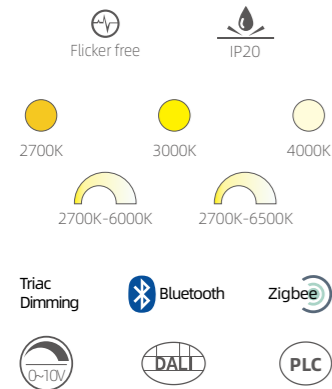

Product information

Power	15W/20W/25W
Beam angle	27°
Input voltage	AC100-240/220-240V
Input frequency	50/60Hz
System Luminous flux	106lm/W
CRI	Ra>90
Finish color	white/black

Mode

DLD0415C-930XY	15W
DLD0415C-940XY	
DLD0420C-930XY	20W
DLD0420C-940XY	
DLD0425C-930XY	25W
DLD0425C-940XY	

Light distribution parameters

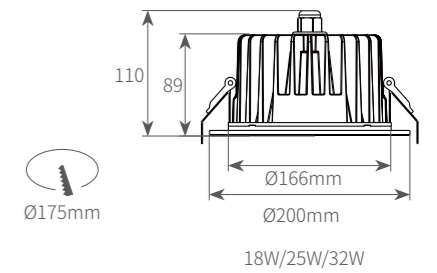
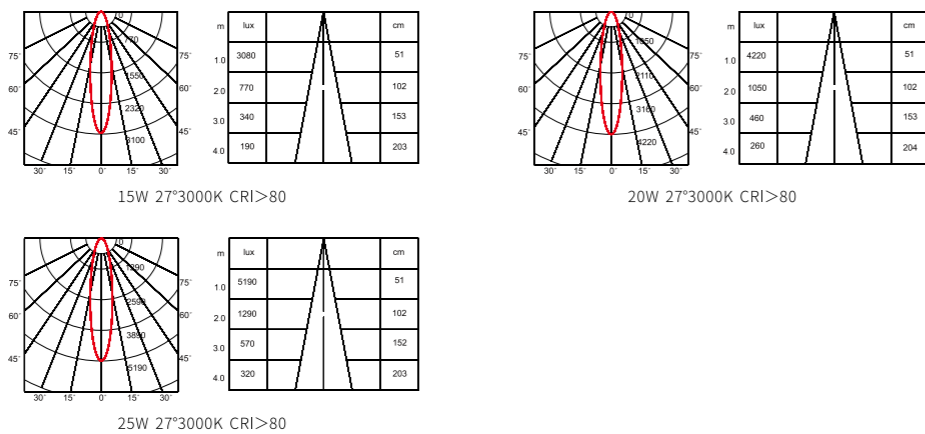

DLD06-A

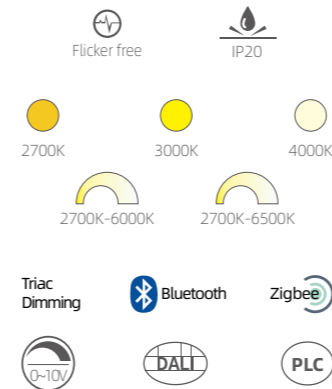

Product information

Power	18W/25W/32W
Beam angle	87°
Input voltage	AC100-240/220-240V
Input frequency	50/60Hz
System Luminous flux	100lm/W
CRI	Ra>90
Finish color	white/black

Mode

DLD0618A-930XY	18W
DLD0618A-940XY	
DLD0625A-930XY	25W
DLD0625A-940XY	
DLD0632A-930XY	32W
DLD0632A-940XY	

Light distribution parameters

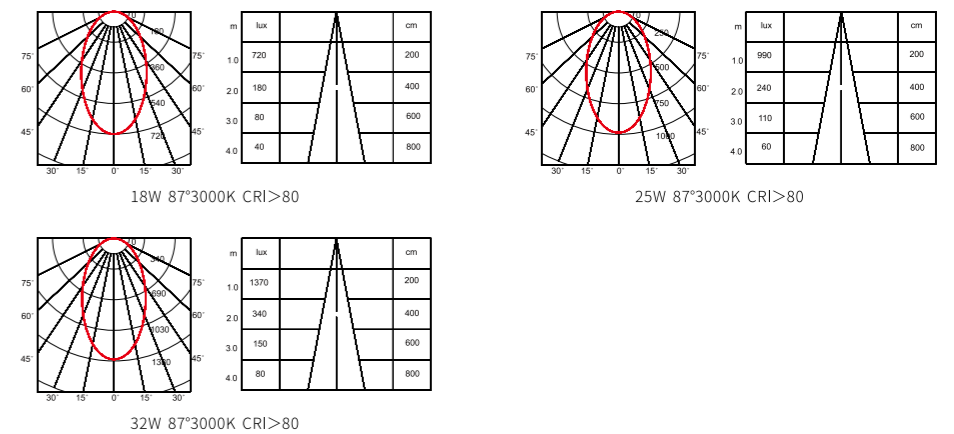

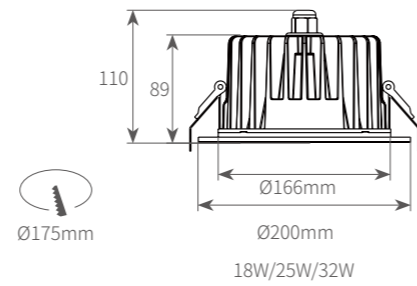

DLD06-B

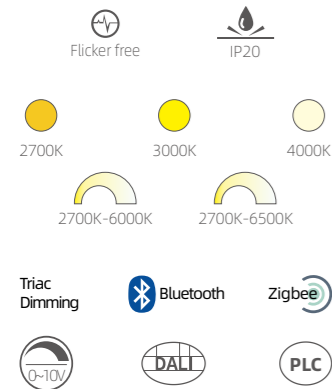

Product information

Power	18W/25W/32W
Beam angle	84°
Input voltage	AC100-240/220-240V
Input frequency	50/60Hz
System Luminous flux	92lm/W
CRI	Ra>90
Finish color	white/black

Mode

DLD0618B-930XY	18W
DLD0618B-940XY	
DLD0625B-930XY	25W
DLD0625B-940XY	
DLD0632B-930XY	32W
DLD0632B-940XY	

Light distribution parameters

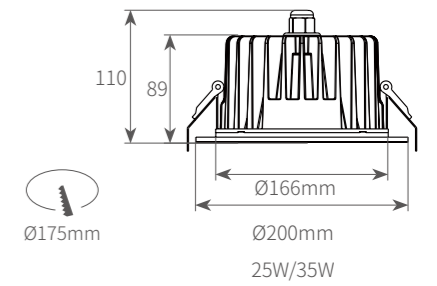
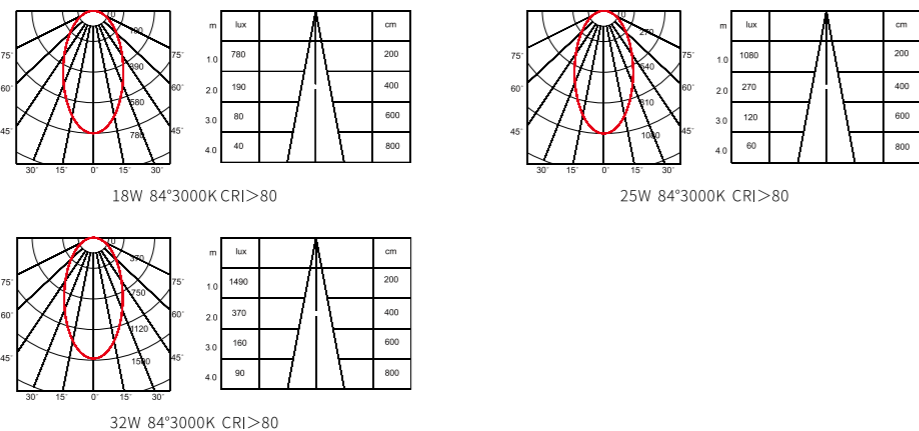

DLD06-C

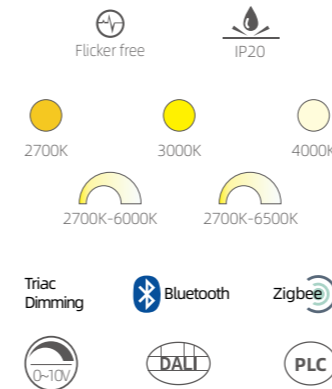

Product information

Power	25W/35W
Beam angle	27°/45°
Input voltage	AC100-240/220-240V
Input frequency	50/60Hz
System Luminous flux	110lm/W
CRI	Ra>90
Finish color	white/black

Mode

DLD0625C-930XY	25W
DLD0625C-940XY	
DLD0635C-930XY	35W
DLD0635C-940XY	

Light distribution parameters

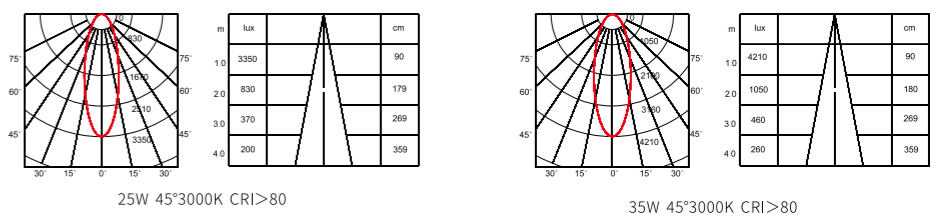

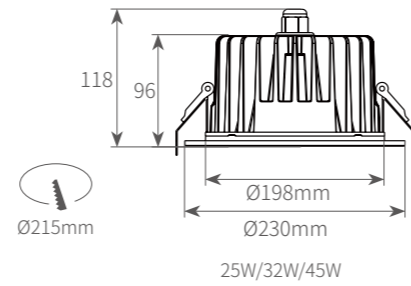

DLD08-A

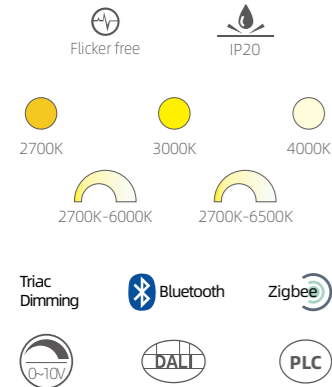

Product information

Power	25W/32W/45W
Beam angle	87°
Input voltage	AC100-240/220-240V
Input frequency	50/60Hz
System Luminous flux	102lm/W
CRI	Ra>90
Finish color	white/black

Mode

DLD0825A-930XY	25W
DLD0825A-940XY	
DLD0832A-930XY	32W
DLD0832A-940XY	
DLD0845A-930XY	45W
DLD0845A-940XY	

Light distribution parameters

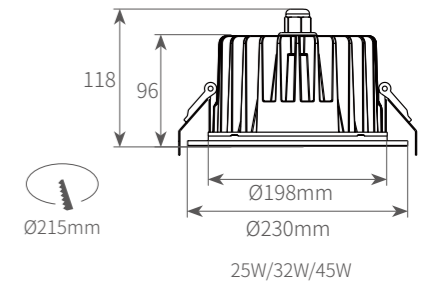
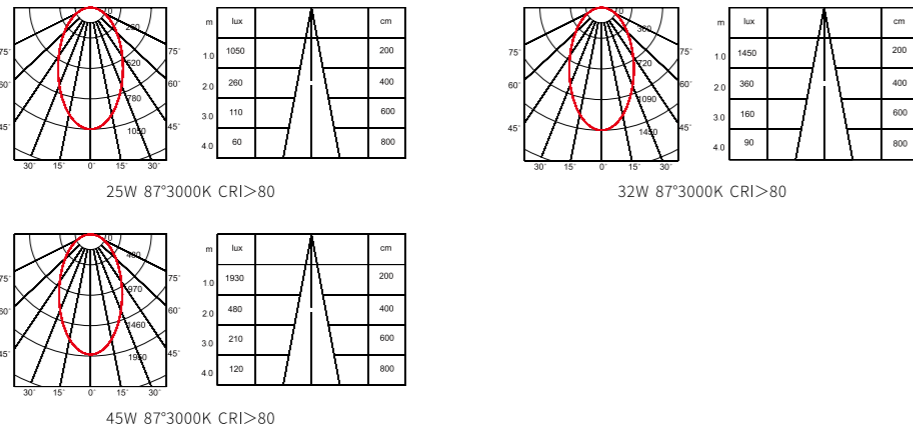

DLD08-B

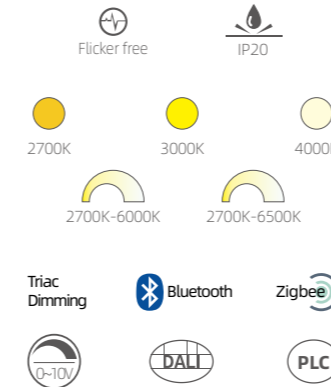

Product information

Power	25W/32W/45W
Beam angle	84°
Input voltage	AC100-240/220-240V
Input frequency	50/60Hz
System Luminous flux	96lm/W
CRI	Ra>90
Finish color	white/black

Mode

DLD0825B-930XY	25W
DLD0825B-940XY	
DLD0832B-930XY	32W
DLD0832B-940XY	
DLD0845B-930XY	45W
DLD0845B-940XY	

Light distribution parameters

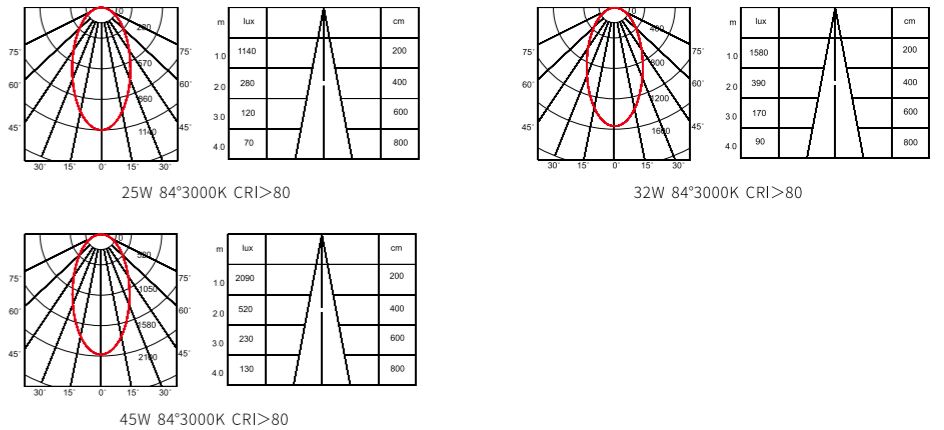

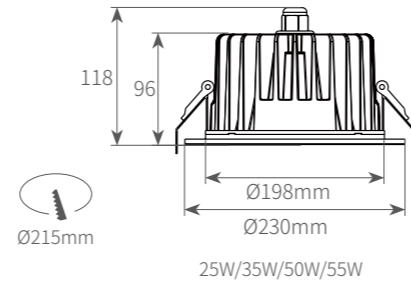

DLD08-C

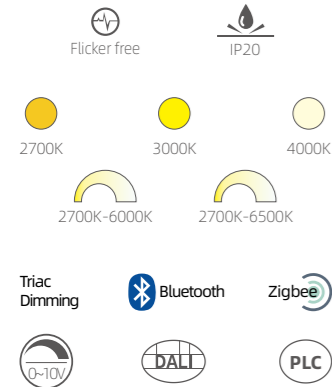

Product information

Power	25W/35W/50W/55W
Beam angle	27°
Input voltage	AC100-240/220-240V
Input frequency	50/60Hz
System Luminous flux	124lm/W
CRI	Ra>90
Finish color	white/black

Mode

DLD0825C-930XY	25W	DLD0850C-930XY	50W
DLD0825C-940XY		DLD0850C-940XY	
DLD0835C-930XY	35W	DLD0855C-930XY	55W
DLD0835C-940XY		DLD0855C-940XY	

Light distribution parameters

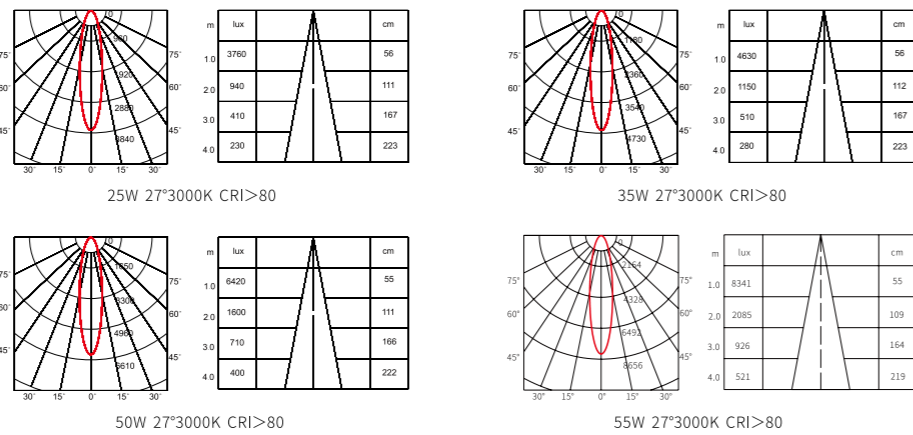

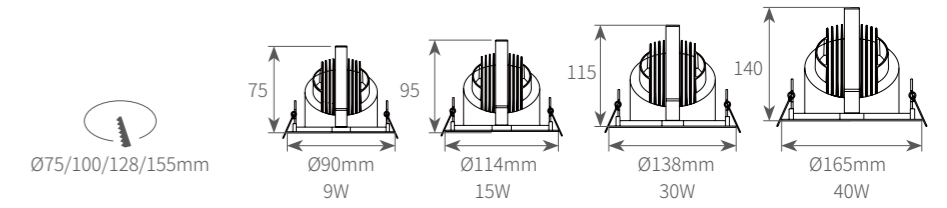

DLG

Product information

Power	9W/15W/30W/40W
Beam angle	15°/24°/38°/45°
Input voltage	AC100-240/220-240V
Input frequency	50/60Hz
System Luminous flux	115lm/W
CRI	Ra>90
Finish color	white/black

Mode

DLG7509-C930XY	9W	DLG13030-C930XY	30W
DLG7509-C940XY		DLG13030-C940XY	
DLG10015-C930XY	15W	DLG15540-C930XY	40W
DLG10015-C940XY		DLG15540-C940XY	

Flicker free
 IP20
 2700K, 3000K, 4000K
 2700K-6000K, 2700K-6500K
 Triac Dimming, 0-10V
 Bluetooth, Zigbee, DALI, PLC

Light distribution parameters

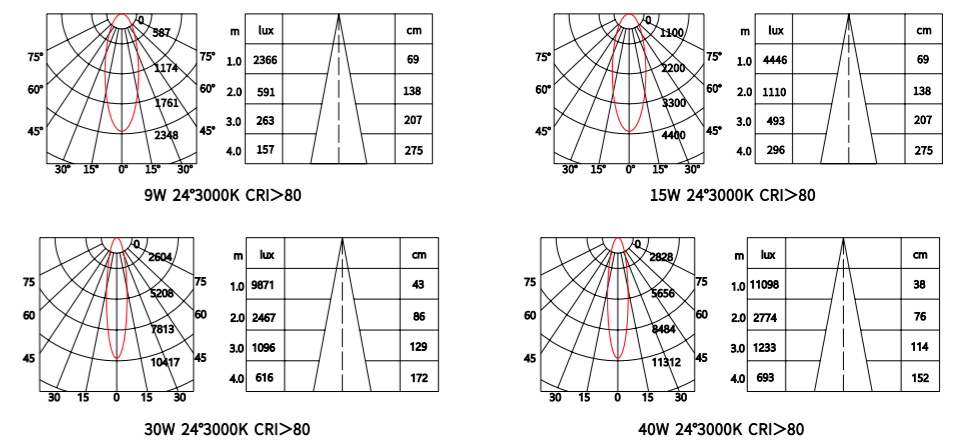

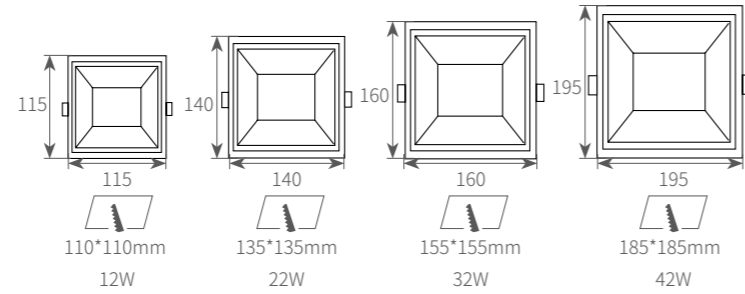
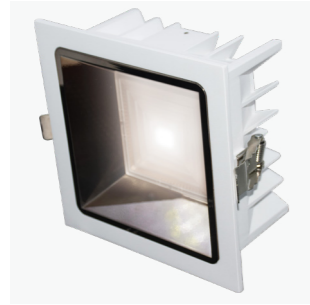

DLS

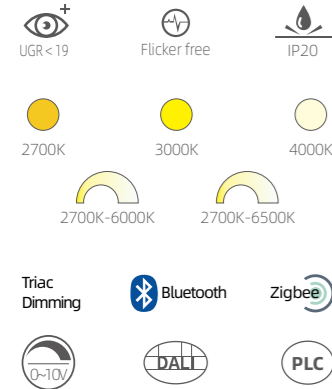

Product information

Power	12W/22W/32W/42W
Beam angle	55°
Input voltage	AC100-240/220-240V
Input frequency	50/60Hz
System Luminous flux	104lm/W
CRI	Ra>90
Finish color	white/black

Mode

DLS0412C-930XY		DLS0632C-930XY	
DLS0412C-940XY	12W	DLS0632C-940XY	32W
DLS0412C-950XY		DLS0632C-950XY	
DLS0522C-930XY		DLS0842C-930XY	
DLS0522C-940XY	22W	DLS0842C-940XY	42W
DLS0522C-950XY		DLS0842C-950XY	

Light distribution parameters

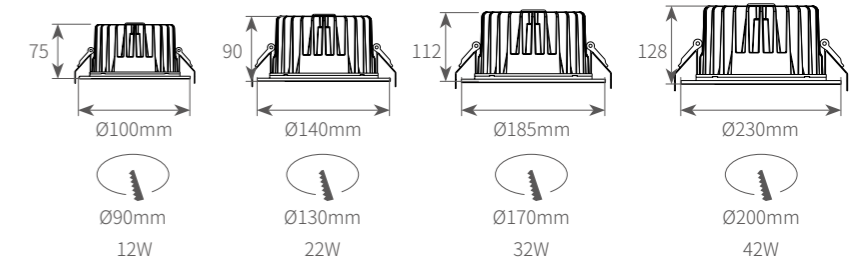
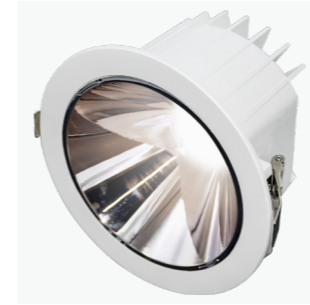
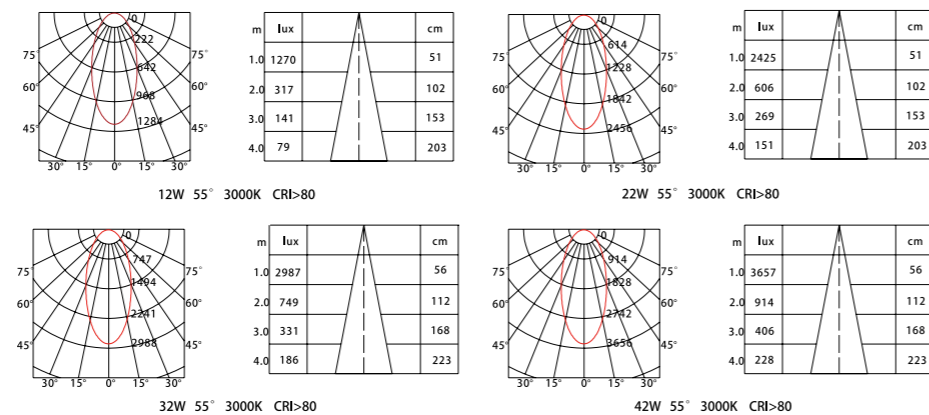

DLW

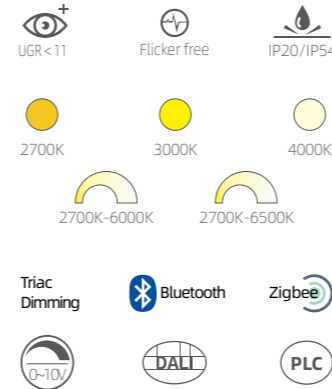

Product information

Power	12W/22W/32W/42W
Beam angle	45°/55°
Input voltage	AC100-240/220-240V
Input frequency	50/60Hz
System Luminous flux	84lm/W
CRI	Ra>90
Finish color	white/black

Mode

DLW0412C-930XY		DLW0632C-930XY	
DLW0412C-940XY	12W	DLW0632C-940XY	32W
DLW0412C-950XY		DLW0632C-950XY	
DLW0522C-930XY		DLW0842C-930XY	
DLW0522C-940XY	22W	DLW0842C-940XY	42W
DLW0522C-950XY		DLW0842C-950XY	

Light distribution parameters

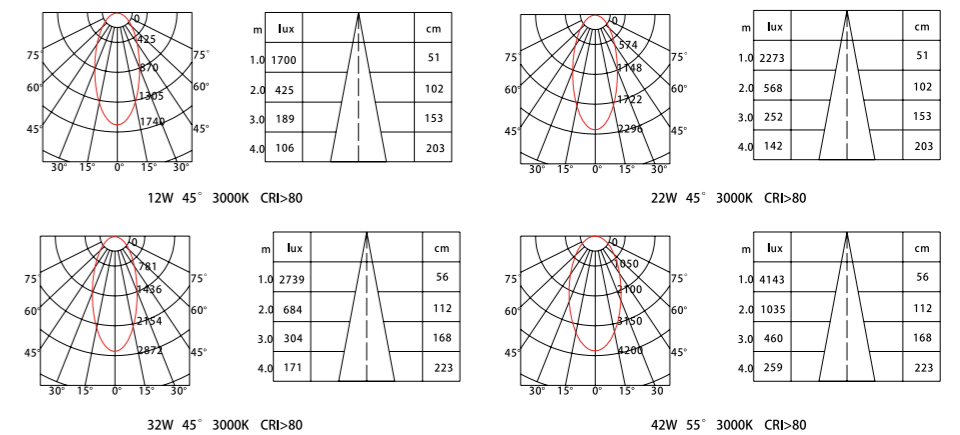

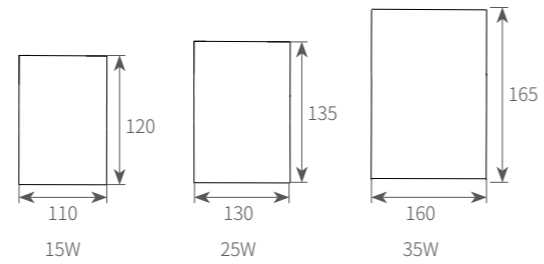

SMS

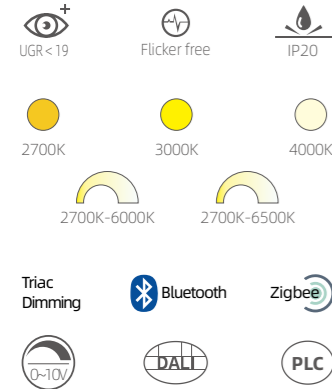

Product information

Power	15W/25W/35W
Beam angle	60°
Input voltage	AC100-240/220-240V
Input frequency	50/60Hz
System Luminous flux	89lm/W
CRI	Ra>90
Finish color	white/black

Mode

SMS0415-C930	15W
SMS0415-C940	
SMS0525-C940	25W
SMS0525-C930	
SMS0635-C940	35W
SMS0635-C930	

Light distribution parameters

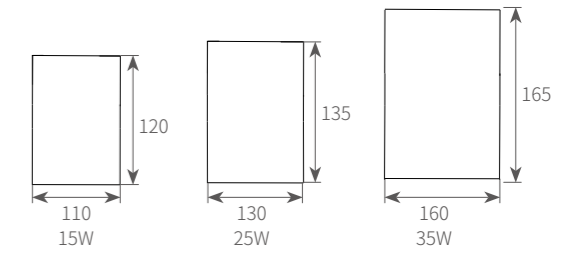
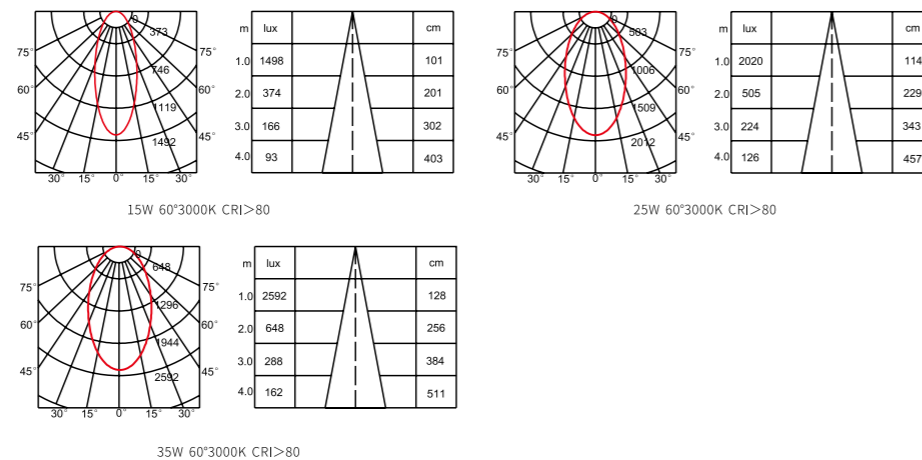

SMS

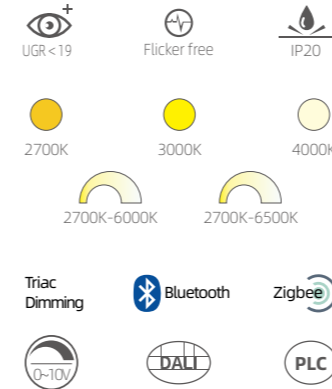

Product information

Power	15W/25W / 35W
Beam angle	70°
Input voltage	AC220-240V
Input frequency	50/60Hz
System Luminous flux	99lm/W
CRI	Ra>90
Finish color	white/black

Mode

SMR0415-C930	15W
SMR0415-C940	
SMR0525-C940	25W
SMR0525-C930	
SMR0635-C940	35W
SMR0635-C930	

Light distribution parameters

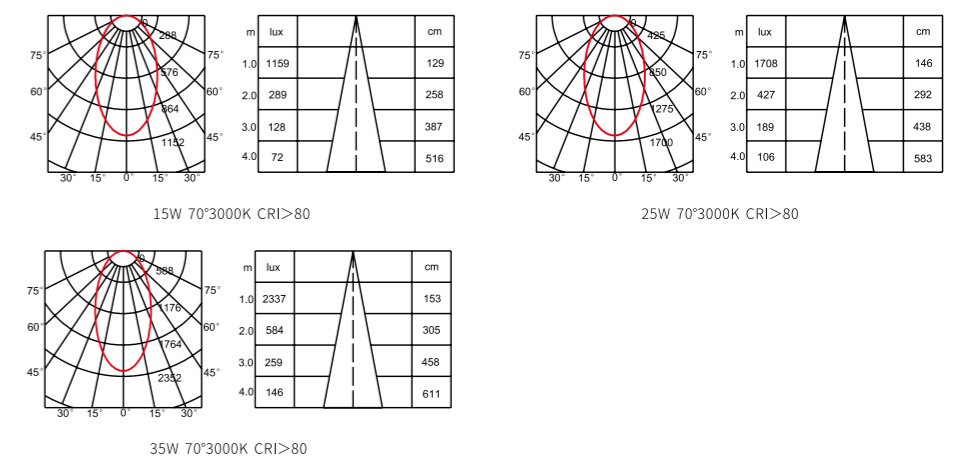

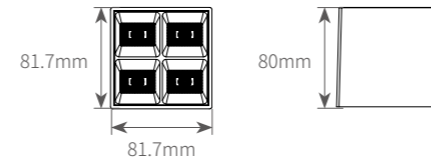

BB0415

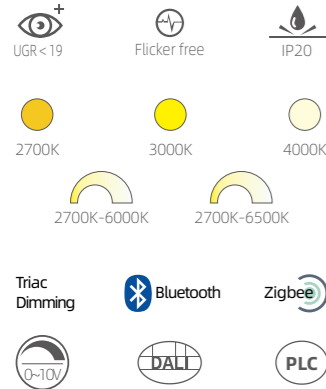

Product information

Power	15W
Beam angle	15°/24°/36°/50°
Input voltage	AC100-240/220-240V
Input frequency	50/60Hz
System Luminous flux	95lm/W
CRI	Ra>90
Finish color	white/black

Product performance

Saturation red reduction degree	R9=90
Color Accuracy	Rf≥92
Color Saturation	Rg=99
Color tolerance	SDCM<3
Light Fixture Material	Aluminium
Installation	Surface Mounted

Light distribution parameters

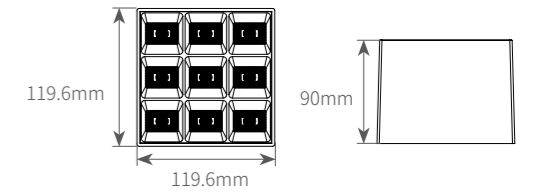
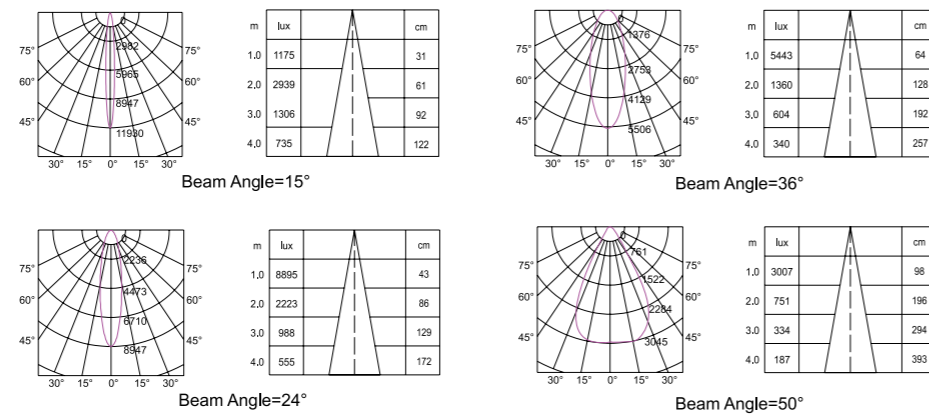

BLD0936

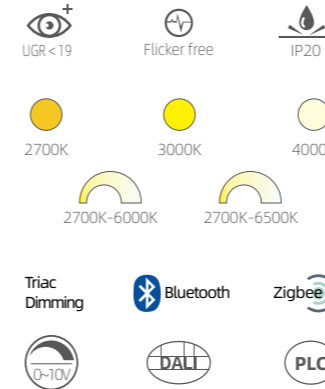

Product information

Power	36W
Beam angle	15°/24°/36°/50°
Input voltage	AC100-240/220-240V
Input frequency	50/60Hz
System Luminous flux	95lm/W
CRI	Ra>90
Finish color	white/black

Product performance

Saturation red reduction degree	R9=90
Color Accuracy	Rf≥92
Color Saturation	Rg=99
Color tolerance	SDCM<3
Light Fixture Material	Aluminium
Installation	Surface Mounted

Light distribution parameters

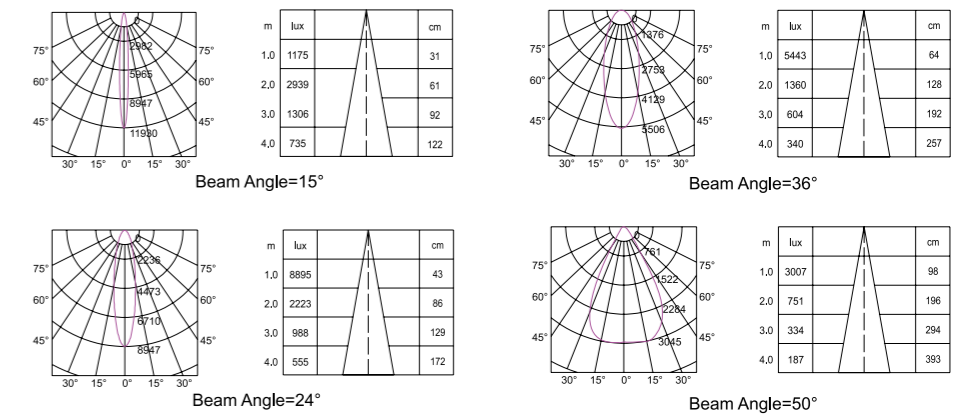

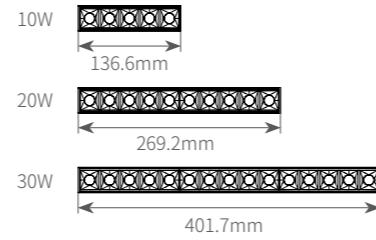

BLD0510/BLD1020/BLD1530

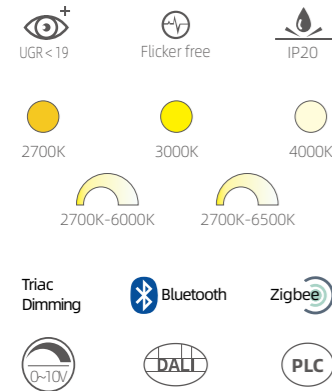

Product information

Power	10W/20W/30W
Beam angle	15°/24°/36°/50°
Input voltage	AC220-240V
Input frequency	50/60Hz
System Luminous flux	111lm/W
CRI	Ra>90
Finish color	white/black

Product performance

Saturation red reduction degree	R9=90
Color Accuracy	Rf≥92
Color Saturation	Rg=99
Color tolerance	SDCM<3
Light Fixture Material	Aluminium
Installation	Surface Mounted

Light distribution parameters

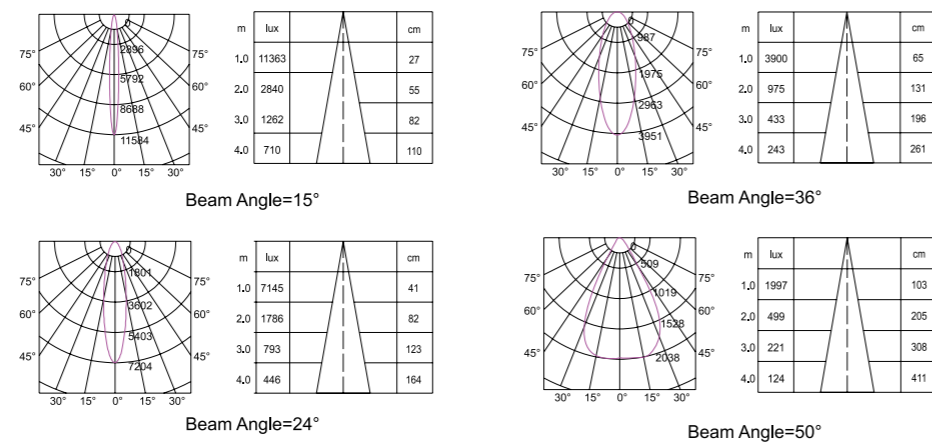

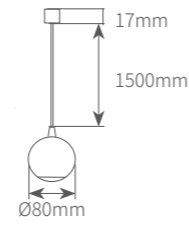
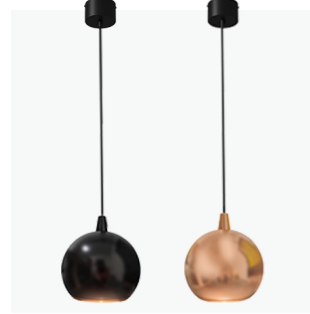

SMP8005

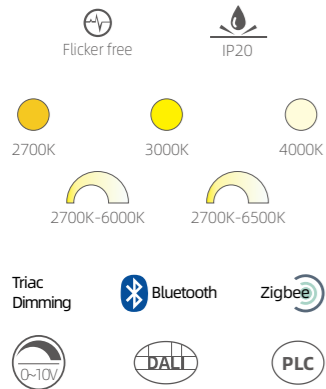

Product information	
Power	5W
Beam angle	75°
Input voltage	24/48V
Input frequency	16KHz
System Luminous flux	60Lm/w
CRI	>90/97
Finish color	rose gold / Pearl black

Product performance	
Saturation red reduction degree	R9=90
Color Accuracy	Rf≥92
Color Saturation	Rg=99
Color tolerance	SDCM<3
Light Fixture Material	Aluminium
Installation	Surface Mounted

Light distribution parameters

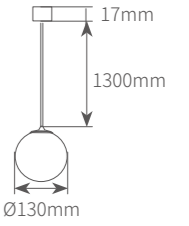
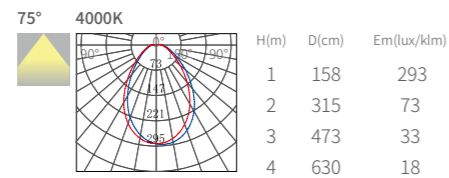
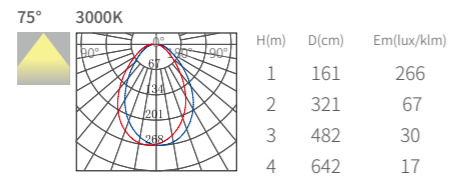

SMP13006

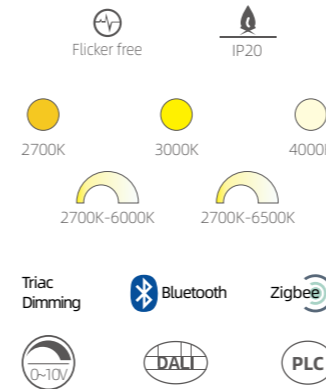

Product information	
Power	6W
Beam angle	220°
Input voltage	AC100-240/220-240V
Input frequency	50/60hz
System Luminous flux	60Lm/w
CRI	>90/97
Finish color	Cloud white

Product performance	
Saturation red reduction degree	R9=90
Color Accuracy	Rf≥92
Color Saturation	Rg=99
Color tolerance	SDCM<3
Light Fixture Material	Aluminium
Installation	Surface Mounted

Light distribution parameters

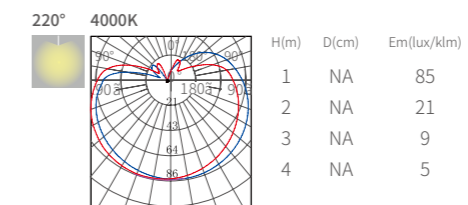
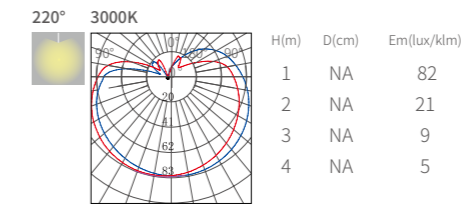

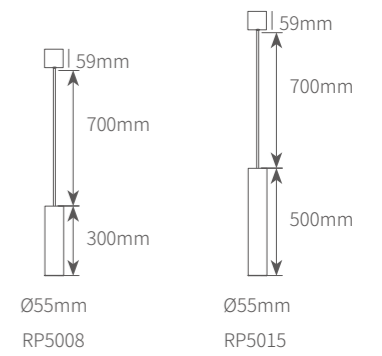
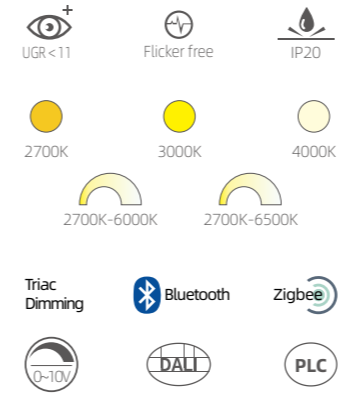

RP5008 /RP5015

Product information

Power	8W/15W
Beam angle	15°/30°/36°
Input voltage	AC100-240/220-240V
Input frequency	50/60hz
System Luminous flux	70Lm/w
CRI	>90/97
Finish color	Sand white / sand black

Product performance

Saturation red reduction degree	R9=90
Color Accuracy	Rf≥92
Color Saturation	Rg=99
Color tolerance	SDCM<3
Light Fixture Material	Aluminium
Installation	Surface Mounted

Light distribution parameters

Beam angle	Color Temp	H(m)	D(cm)	Em(lux/klm)
15°	3000K	1	36	3173
		2	72	793
		3	108	353
		4	144	198
15°	4000K	1	39	4029
		2	77	1007
		3	116	448
		4	193	252
30°	3000K	1	46	2478
		2	92	590
		3	138	275
		4	184	155
30°	4000K	1	45	3151
		2	90	788
		3	135	350
		4	180	197
36°	3000K	1	65	1475
		2	129	368
		3	194	164
		4	258	92
36°	4000K	1	61	1942
		2	123	486
		3	184	216
		4	245	121

AR111 & GRILLE LIGHT
SERIES



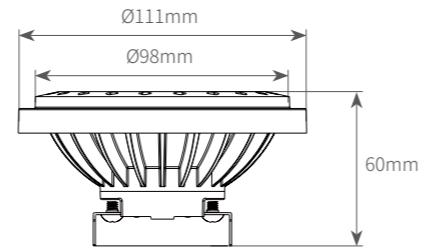

AR111-A

Product information

Power	10W/12W/16W
Beam angle	15°/30°
Input voltage	AC/DC 12V
Input frequency	50/60Hz
System Luminous flux	117lm/W
CRI	Ra>90
Finish color	Silver

Product performance

Saturation red reduction degree	R9=90
Color Accuracy	Rf≥92
Color Saturation	Rg=99
Color tolerance	SDCM<3
Light Fixture Material	Aluminium
Installation	G53

Light distribution parameters

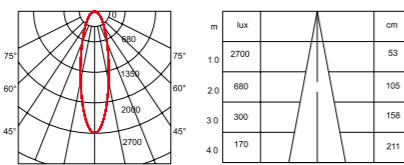

10W 30°3000K CRI>90

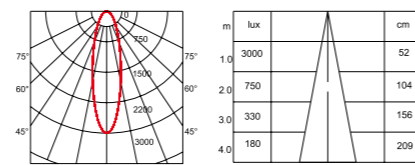

12W 30°3000K CRI>90

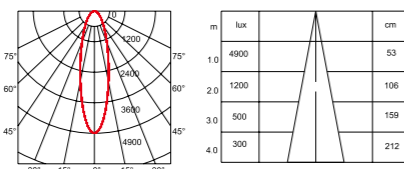

16W 30°3000K CRI>90

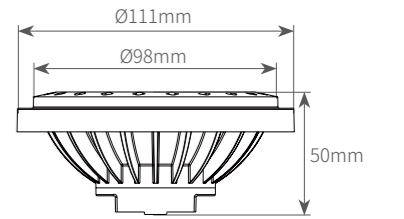

AR111-B

Product information

Power	10W/12W/16W
Beam angle	15°/30°
Input voltage	AC100-240/220-240V
Input frequency	50/60Hz
System Luminous flux	117lm/W
CRI	Ra>90
Finish color	Silver

Product performance

Saturation red reduction degree	R9=90
Color Accuracy	Rf≥92
Color Saturation	Rg=99
Color tolerance	SDCM<3
Light Fixture Material	Aluminium
Installation	Recessed

Light distribution parameters

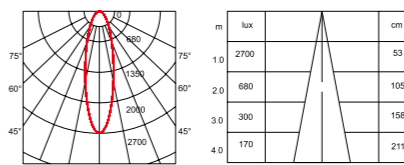

10W 30°3000K CRI>90

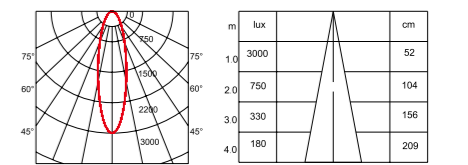

12W 30°3000K CRI>90

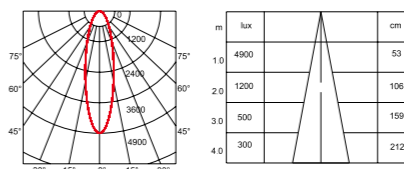

16W 30°3000K CRI>90

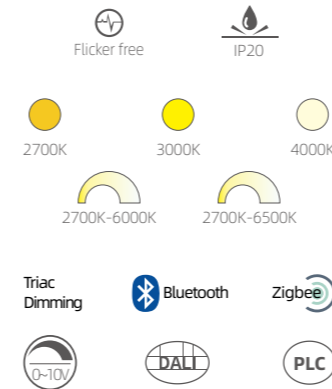
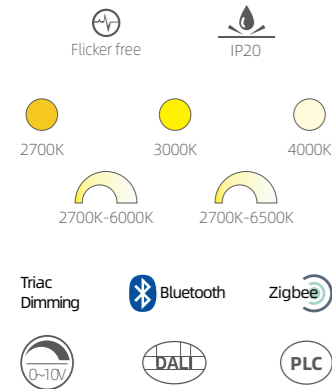

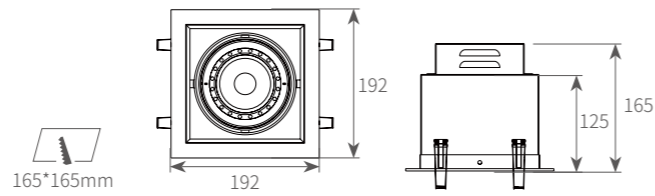

AR02-1

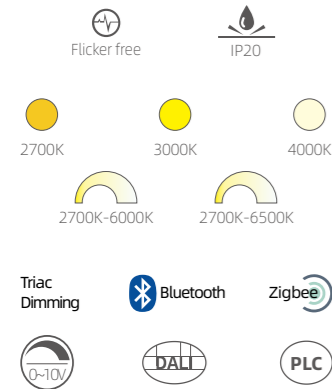

Product information

Power	10W/12W/16W
Beam angle	15°/30°
Input voltage	AC100-240/220-240V
Input frequency	50/60Hz
System Luminous flux	117lm/W
CRI	Ra>90
Finish color	white/black

Product performance

Saturation red reduction degree	R9=90
Color Accuracy	Rf≥92
Color Saturation	Rg=99
Color tolerance	SDCM<3
Light Fixture Material	Aluminium
Installation	Recessed

Light distribution parameters

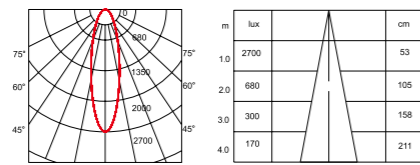

10W 30°3000K CRI>90

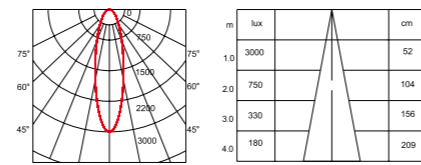

12W 30°3000K CRI>90

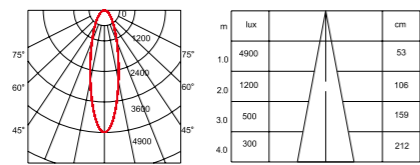

16W 30°3000K CRI>90

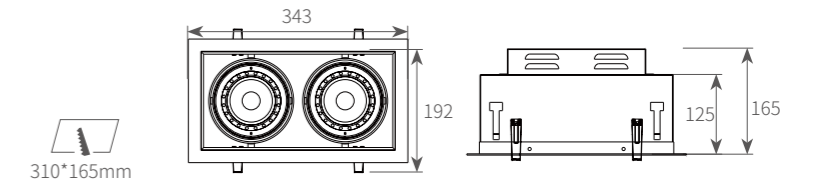

AR02-2



Product information

Power	10W*2/12W*2/16W*2
Beam angle	15°/30°
Input voltage	AC100-240/220-240V
Input frequency	50/60Hz
System Luminous flux	91lm/W
CRI	Ra>90
Finish color	white/black

Product performance

Saturation red reduction degree	R9=90
Color Accuracy	Rf≥92
Color Saturation	Rg=99
Color tolerance	SDCM<3
Light Fixture Material	Aluminium
Installation	Recessed

Light distribution parameters

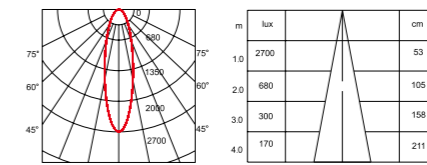

2*10W 30°3000K CRI>90

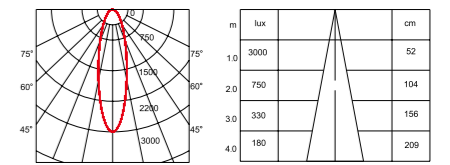

2*12W 30°3000K CRI>90

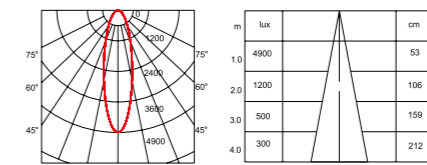

2*16W 30°3000K CRI>90

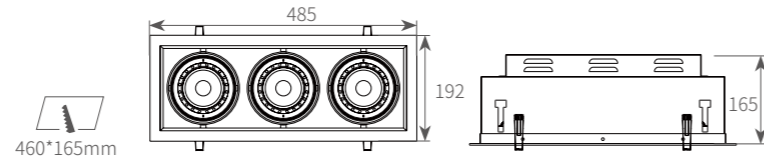

AR02-3

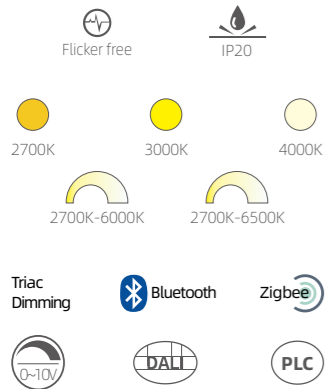

Product information

Power	10W*3/12W*3/16W*3
Beam angle	15°/30°
Input voltage	AC100-240/220-240V
Input frequency	50/60Hz
System Luminous flux	91lm/W
CRI	Ra>90
Finish color	white/black

Product performance

Saturation red reduction degree	R9=90
Color Accuracy	Rf≥92
Color Saturation	Rg=99
Color tolerance	SDCM<3
Light Fixture Material	Aluminium
Installation	Recessed

Light distribution parameters

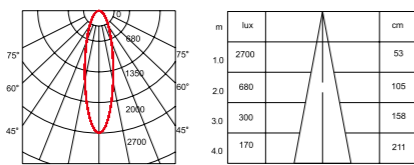

3*10W 30°3000K CRI>90

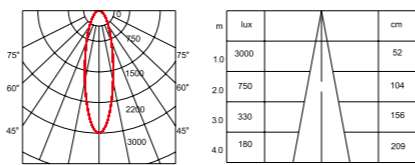

3*12W 30°3000K CRI>90

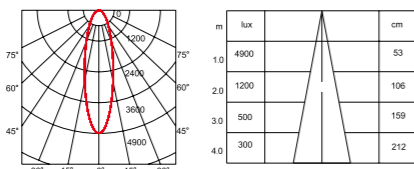

3*16W 30°3000K CRI>90

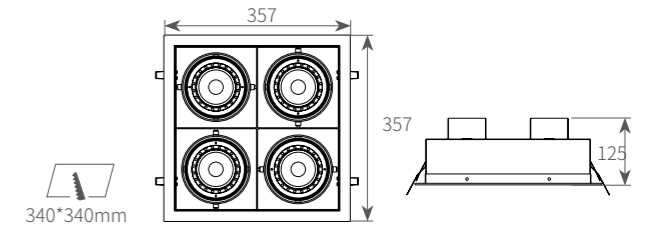

AR02-4

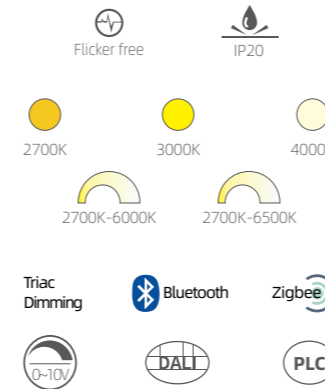

Product information

Power	10W*4/12W*4/16W*4
Beam angle	15°/30°
Input voltage	AC100-240/220-240V
Input frequency	50/60Hz
System Luminous flux	91lm/W
CRI	Ra>90
Finish color	white/black

Product performance

Saturation red reduction degree	R9=90
Color Accuracy	Rf≥92
Color Saturation	Rg=99
Color tolerance	SDCM<3
Light Fixture Material	Aluminium
Installation	Recessed

Light distribution parameters

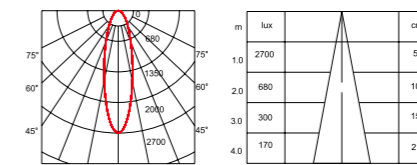

10W*4 30°3000K CRI>90

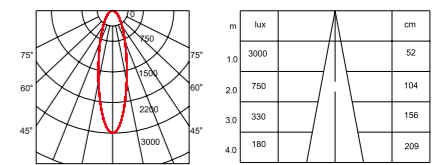

12W*4 30°3000K CRI>90

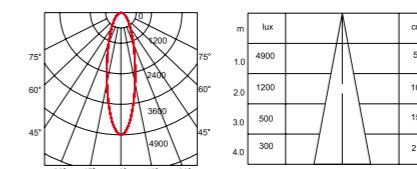

16W*4 30°3000K CRI>90

LED TRACK
LIGHT SERIES



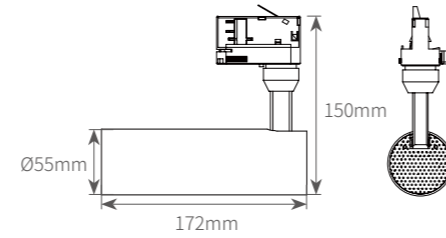

RT55-AL

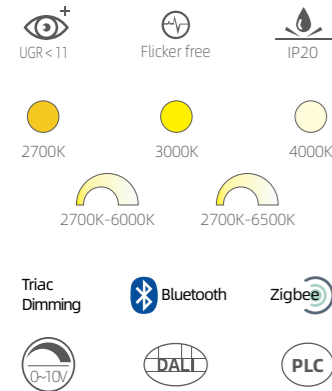

Product information

Power	8W/12W/15W
Beam angle	15°/24°/36°
Input voltage	220-240V
Input frequency	50/60Hz
System Luminous flux	82lm/W
CRI	>90/97
Finish color	Sand white / sand black

Product performance

Saturation red reduction degree	R9=90
Color Accuracy	Rf≥92
Color Saturation	Rg=99
Color tolerance	SDCM<3
Light Fixture Material	Aluminium
Installation	Track

Light distribution parameters

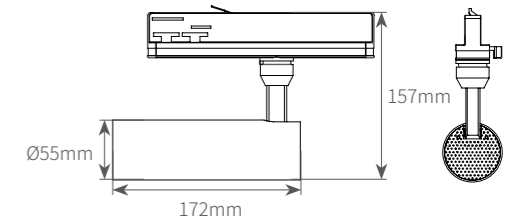
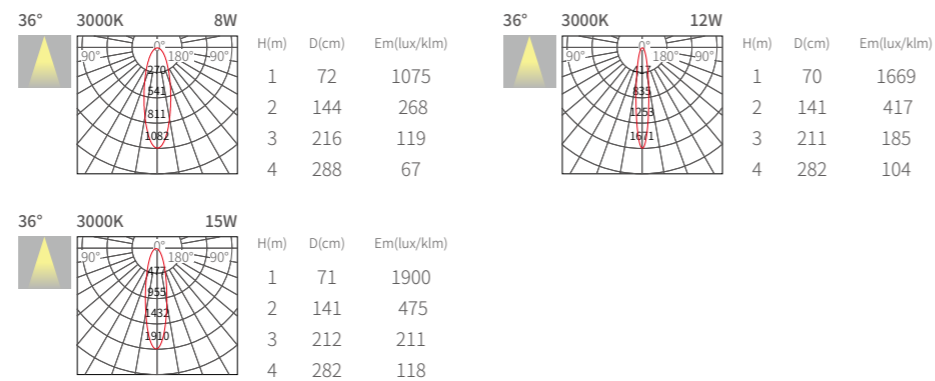

RT55-BL

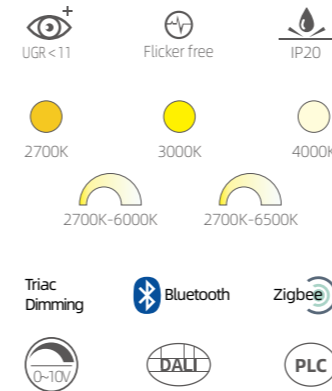

Product information

Power	8W/12W/15W
Beam angle	15°/24°/36°
Input voltage	220-240V
Input frequency	50/60Hz
System Luminous flux	82lm/W
CRI	>90/97
Finish color	Sand white / sand black

Product performance

Saturation red reduction degree	R9=90
Color Accuracy	Rf≥92
Color Saturation	Rg=99
Color tolerance	SDCM<3
Light Fixture Material	Aluminium
Installation	Track

Light distribution parameters

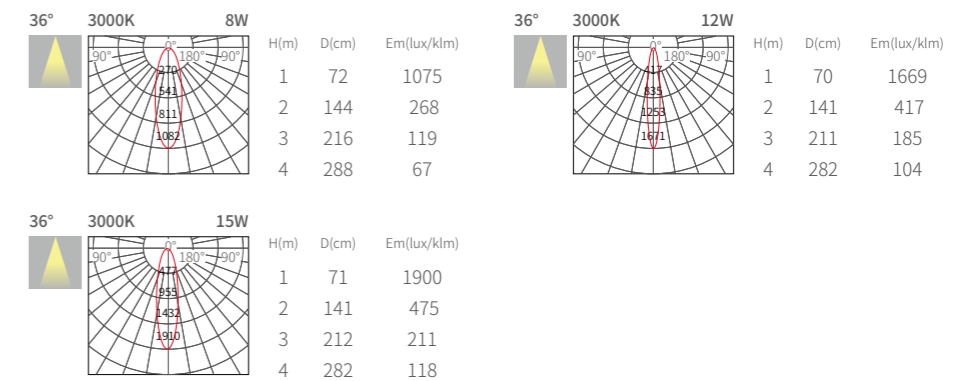

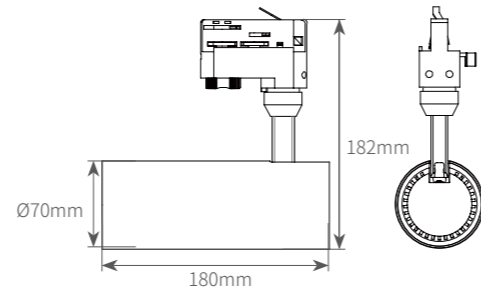

RT69-AL/RT69-AD

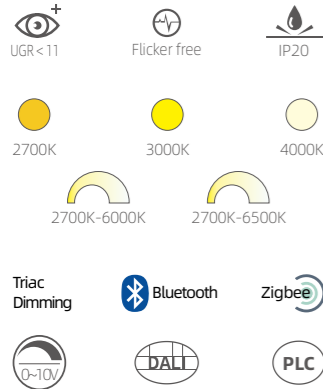

Product information

Power	8W/12W/15W
Beam angle	15°/24°/36°
Input voltage	220-240V
Input frequency	50/60Hz
System Luminous flux	95lm/W
CRI	>90/97
Finish color	Sand white / sand black

Product performance

Saturation red reduction degree	R9=90
Color Accuracy	Rf≥92
Color Saturation	Rg=99
Color tolerance	SDCM<3
Light Fixture Material	Aluminium
Installation	Track

Light distribution parameters

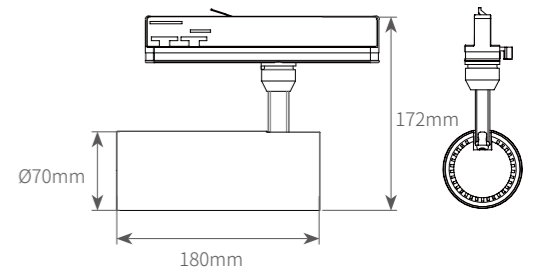
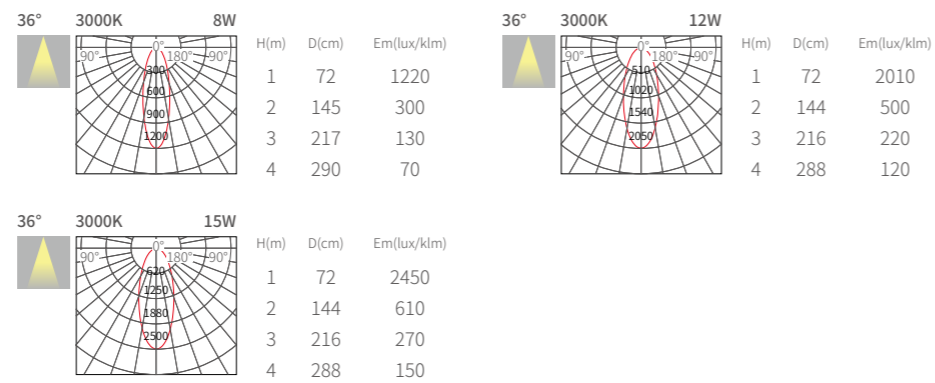

RT69-BL/RT69-BD

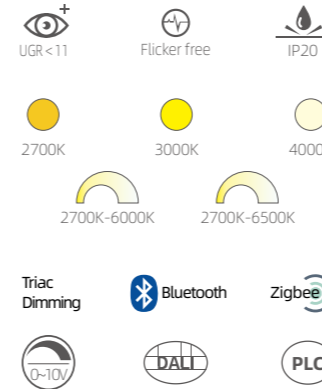

Product information

Power	8W/12W/15W
Beam angle	15°/24°/36°
Input voltage	220-240V
Input frequency	50/60Hz
System Luminous flux	95lm/W
CRI	>90/97
Finish color	Sand white / sand black

Product performance

Saturation red reduction degree	R9=90
Color Accuracy	Rf≥92
Color Saturation	Rg=99
Color tolerance	SDCM<3
Light Fixture Material	Aluminium
Installation	Track

Light distribution parameters

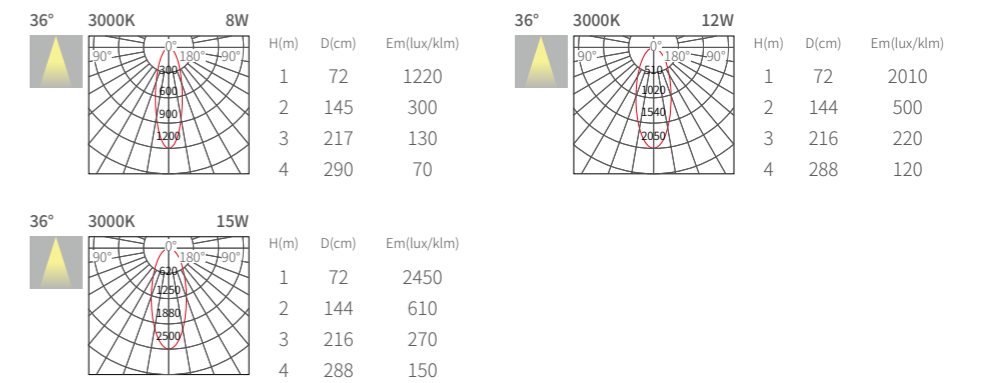

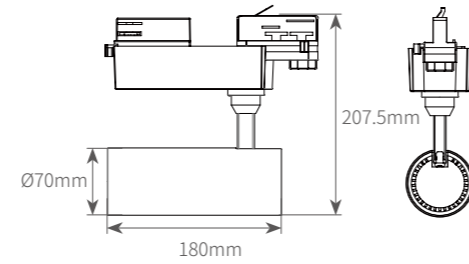

RT69-CL/RT69-CD

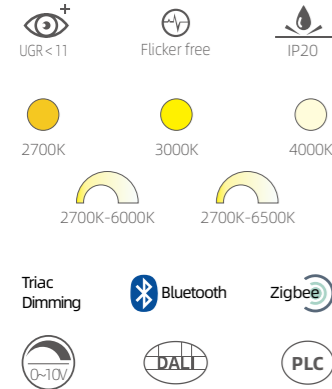

Product information

Power	8W/12W/15W
Beam angle	15°/24°/36°
Input voltage	220-240V
Input frequency	50/60Hz
System Luminous flux	95lm/W
CRI	>90/97
Finish color	Sand white / sand black

Product performance

Saturation red reduction degree	R9=90
Color Accuracy	Rf≥92
Color Saturation	Rg=99
Color tolerance	SDCM<3
Light Fixture Material	Aluminium
Installation	Track

Light distribution parameters

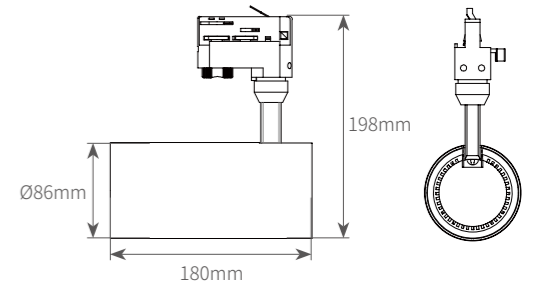
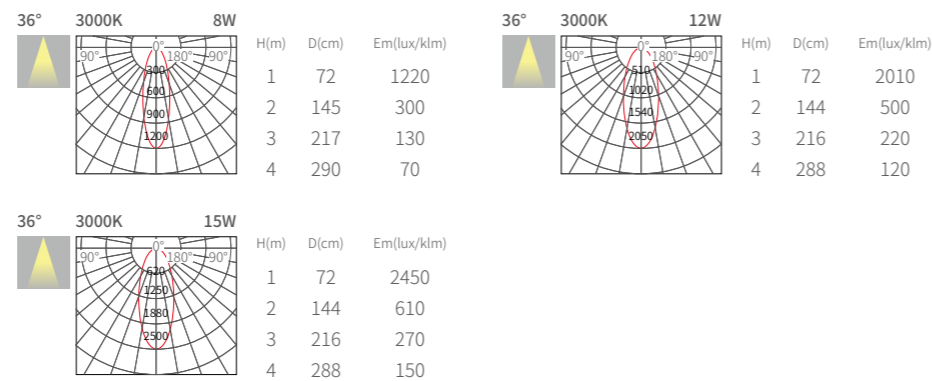

RT86-AL/RT86-AD

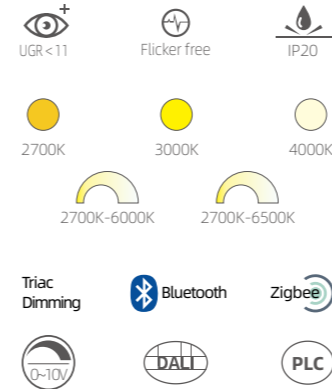

Product information

Power	8W/12W/15W
Beam angle	15°/24°/36°
Input voltage	220-240V
Input frequency	50/60Hz
System Luminous flux	80lm/W
CRI	>90/97
Finish color	Sand white / sand black

Product performance

Saturation red reduction degree	R9=90
Color Accuracy	Rf≥92
Color Saturation	Rg=99
Color tolerance	SDCM<3
Light Fixture Material	Aluminium
Installation	Track

Light distribution parameters

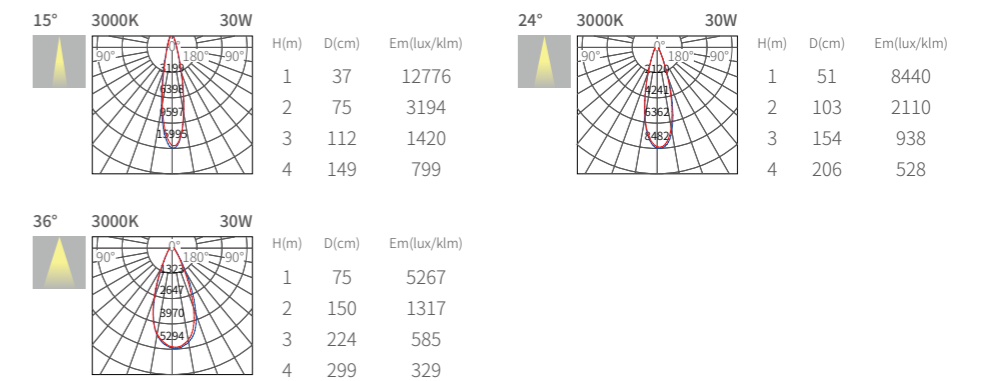

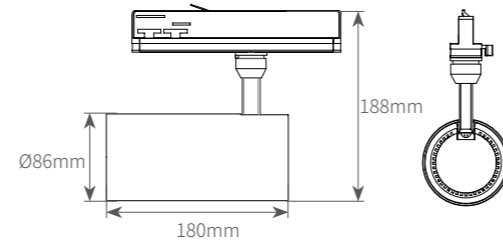

RT86-BL/RT86-BD

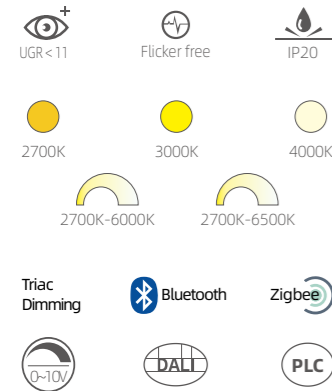

Product information

Power	8W/12W/15W
Beam angle	15°/24°/36°
Input voltage	220-240V
Input frequency	50/60Hz
System Luminous flux	80lm/W
CRI	>90/97
Finish color	Sand white / sand black

Product performance

Saturation red reduction degree	R9=90
Color Accuracy	Rf≥92
Color Saturation	Rg=99
Color tolerance	SDCM<3
Light Fixture Material	Aluminium
Installation	Track

Light distribution parameters

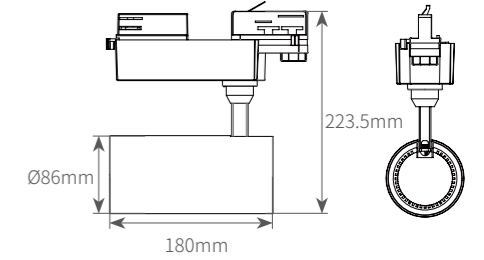
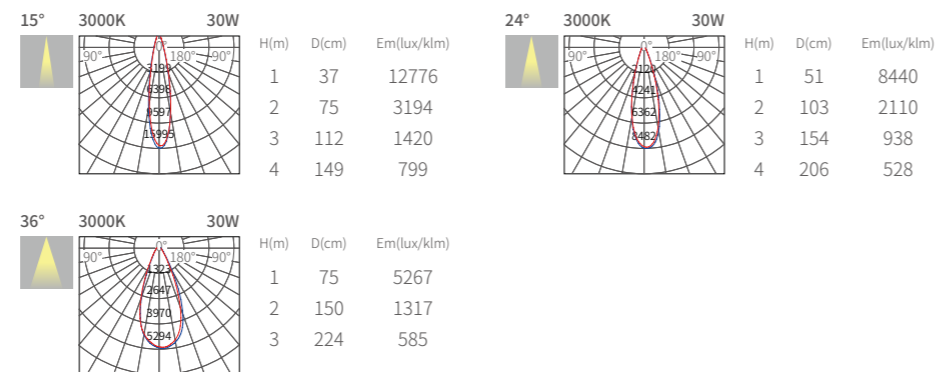

RT86-CL/RT86-CD

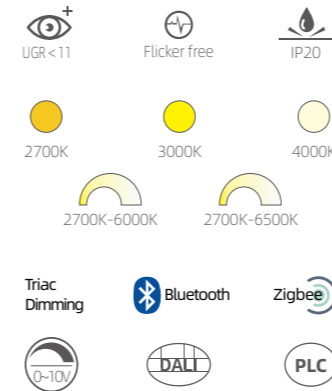

Product information

Power	8W/12W/15W
Beam angle	15°/24°/36°
Input voltage	220-240V
Input frequency	50/60Hz
System Luminous flux	80lm/W
CRI	>90/97
Finish color	Sand white / sand black

Product performance

Saturation red reduction degree	R9=90
Color Accuracy	Rf≥92
Color Saturation	Rg=99
Color tolerance	SDCM<3
Light Fixture Material	Aluminium
Installation	Track

Light distribution parameters

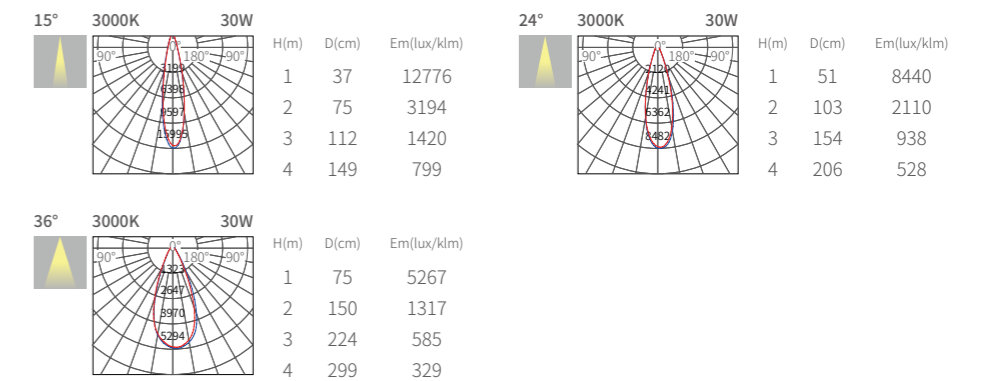

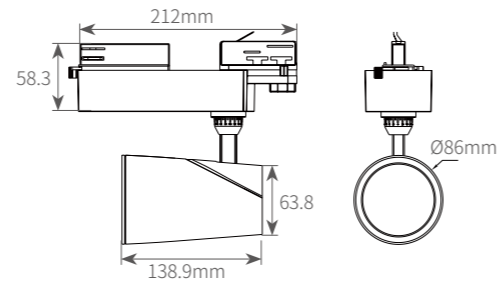

RT80

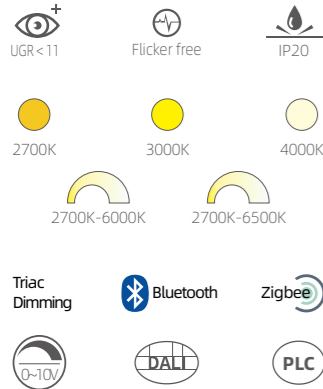

Product information

Power	15W/20W/28W
Beam angle	12°/22°/36°
Input voltage	220-240V
Input frequency	50/60Hz
System Luminous flux	74lm/W
CRI	>90/97
Finish color	Sand white / sand black

Product performance

Saturation red reduction degree	R9=90
Color Accuracy	Rf≥92
Color Saturation	Rg=99
Color tolerance	SDCM<3
Light Fixture Material	Aluminium
Installation	Track

Light distribution parameters

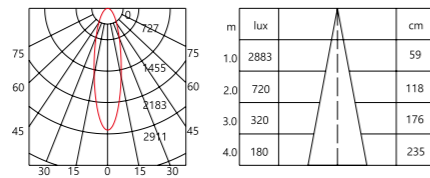

15W 36°3000K CRI>90

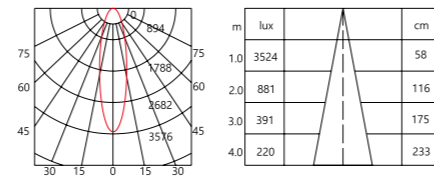

20W 36°3000K CRI>90

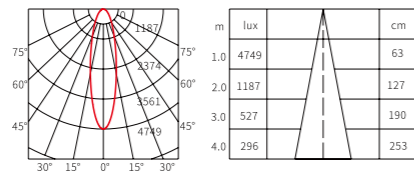

28W 36°3000K CRI>90

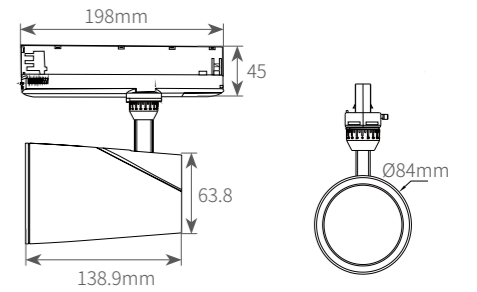

RT80P

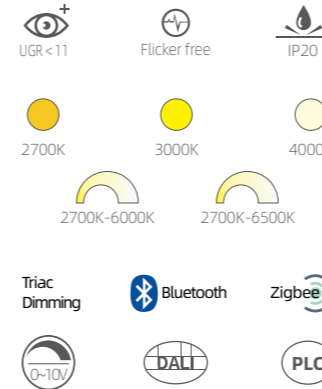

Product information

Power	15W/20W/28W
Beam angle	12°/22°/36°
Input voltage	220-240V
Input frequency	50/60Hz
System Luminous flux	74lm/W
CRI	>90/97
Finish color	Sand white / sand black

Product performance

Saturation red reduction degree	R9=90
Color Accuracy	Rf≥92
Color Saturation	Rg=99
Color tolerance	SDCM<3
Light Fixture Material	Aluminium
Installation	Track

Light distribution parameters

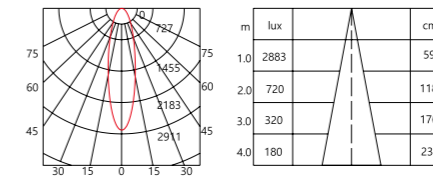

15W 36°3000K CRI>90

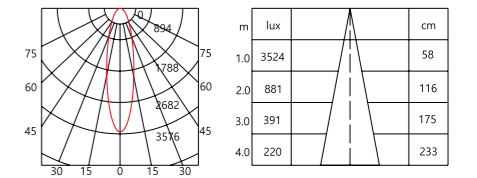

20W 36°3000K CRI>90

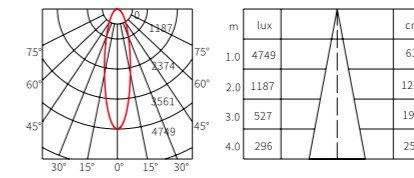

28W 36°3000K CRI>90

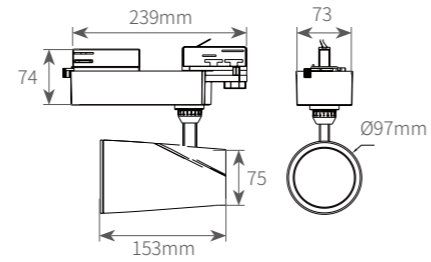

RT95

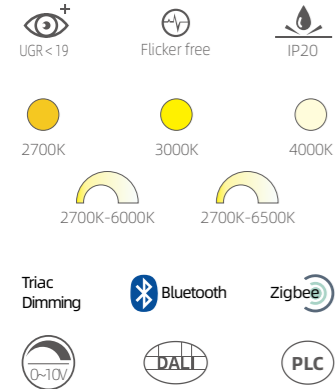

Product information

Power	30W/35W/40W
Beam angle	12°/22°/36°
Input voltage	220-240V
Input frequency	50/60Hz
System Luminous flux	90lm/W
CRI	>90/97
Finish color	Sand white / sand black

Product performance

Saturation red reduction degree	R9=90
Color Accuracy	Rf≥92
Color Saturation	Rg=99
Color tolerance	SDCM<3
Light Fixture Material	Aluminium
Installation	Track

Light distribution parameters

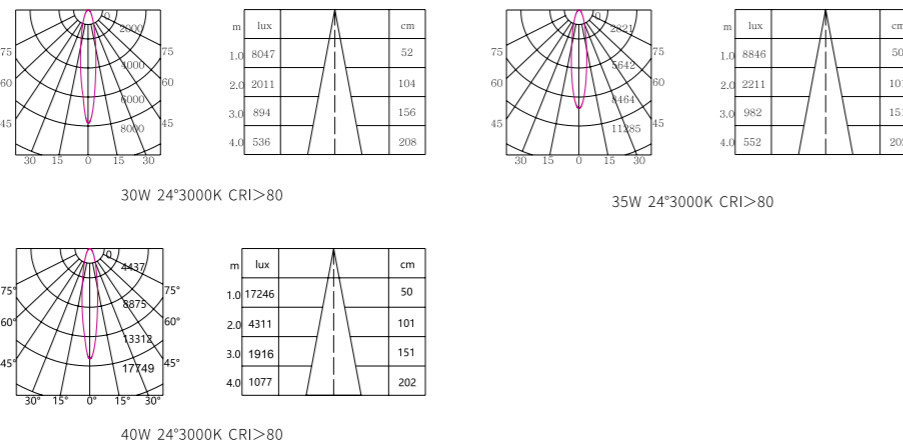

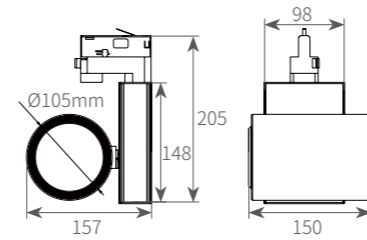

RT105-A

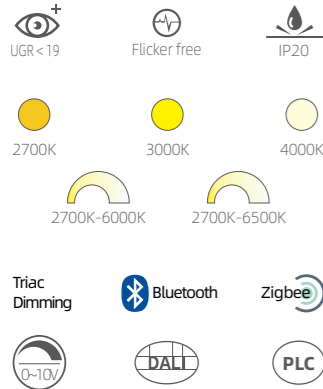

Product information

Power	30W/35W/45W/56W
Beam angle	12°/24°/40°/60°
Input voltage	AC100-240/220-240V
Input frequency	50/60Hz
System Luminous flux	100lm/W
CRI	>90
Finish color	Sand white / sand black

Product performance

Saturation red reduction degree	R9=90
Color Accuracy	Rf≥92
Color Saturation	Rg=99
Color tolerance	SDCM<3
Light Fixture Material	Aluminium
Installation	Track

Light distribution parameters

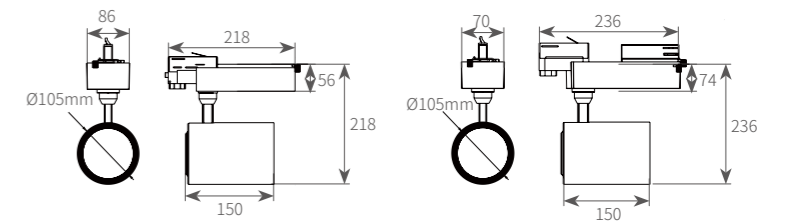
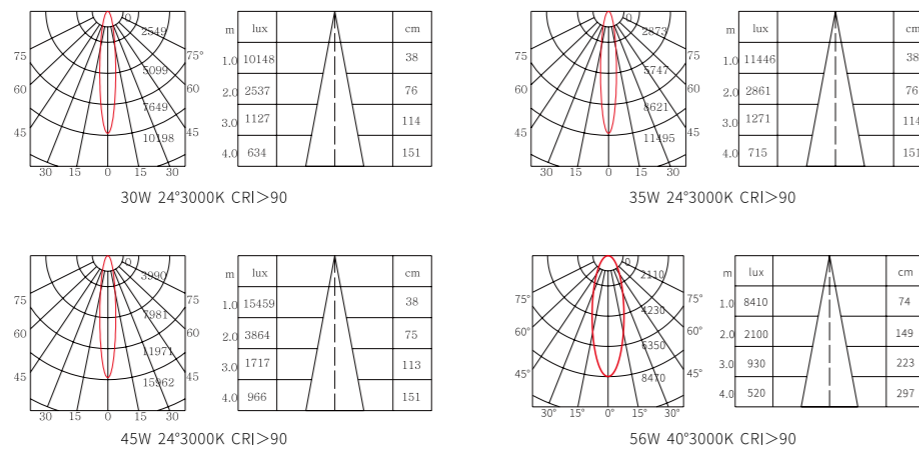

RT105-B

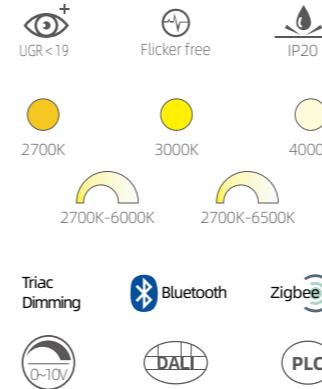

Product information

Power	30W/35W/45W/56W
Beam angle	12°/24°/40°/60°
Input voltage	AC100-240/220-240V
Input frequency	50/60Hz
System Luminous flux	100lm/W
CRI	>90
Finish color	Sand white / sand black

Product performance

Saturation red reduction degree	R9=90
Color Accuracy	Rf≥92
Color Saturation	Rg=99
Color tolerance	SDCM<3
Light Fixture Material	Aluminium
Installation	Track

Light distribution parameters

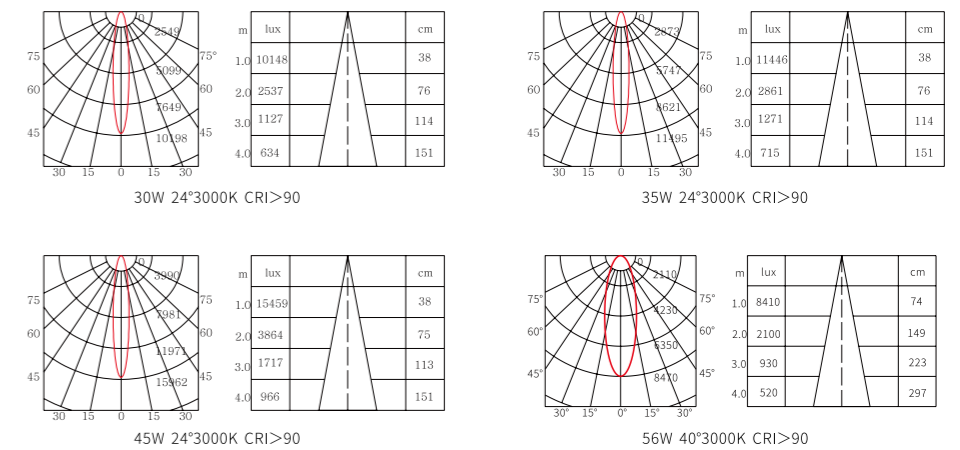

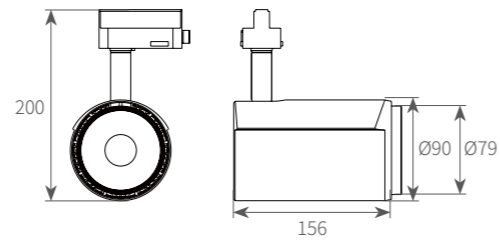

RT90

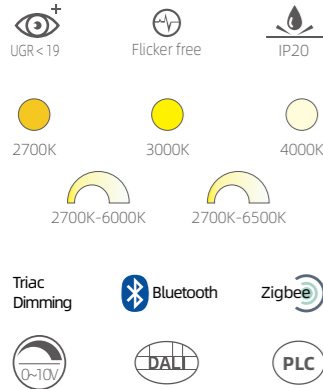

Product information

Power	20W/25W/30W/35W
Beam angle	12°/24°/36°/60°
Input voltage	AC100-240/220-240V
Input frequency	50/60Hz
System Luminous flux	97lm/W
CRI	>90
Finish color	Sand white / sand black

Product performance

Saturation red reduction degree	R9=90
Color Accuracy	Rf≥92
Color Saturation	Rg=99
Color tolerance	SDCM<3
Light Fixture Material	Aluminium
Installation	Track

Light distribution parameters

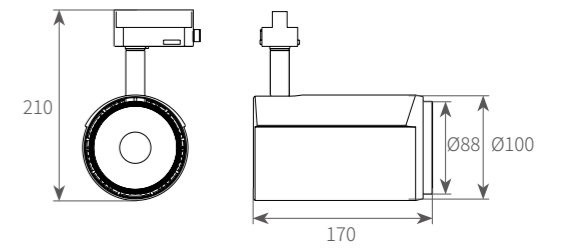
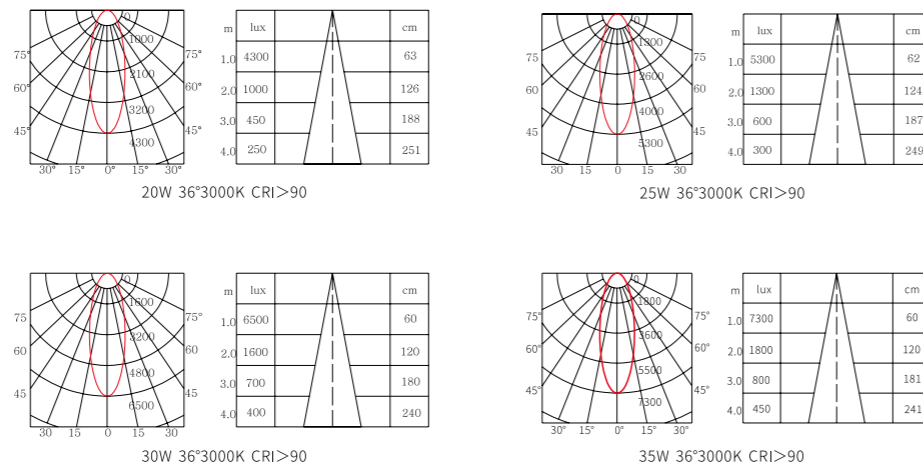

RT100

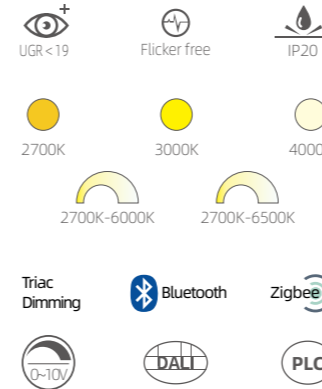

Product information

Power	40W/45W
Beam angle	15°/24°/36°/60°
Input voltage	AC100-240/220-240V
Input frequency	50/60Hz
System Luminous flux	103lm/W
CRI	>90
Finish color	Sand white / sand black

Product performance

Saturation red reduction degree	R9=90
Color Accuracy	Rf≥92
Color Saturation	Rg=99
Color tolerance	SDCM<3
Light Fixture Material	Aluminium
Installation	Track

Light distribution parameters

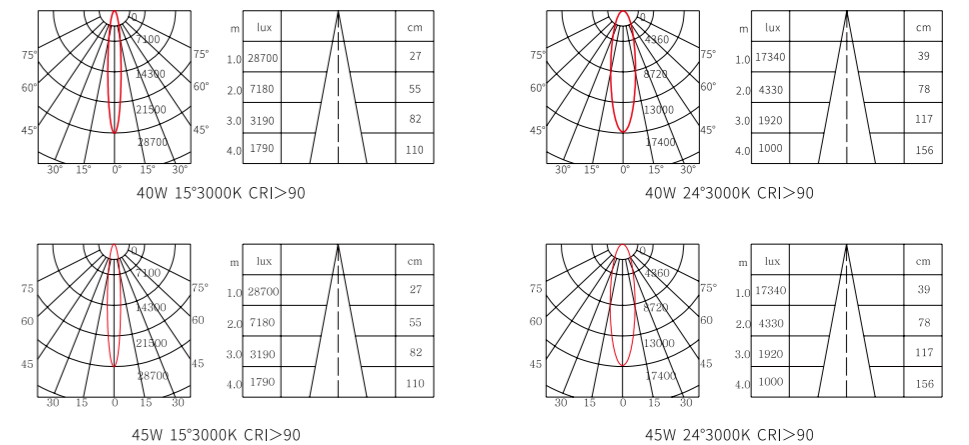

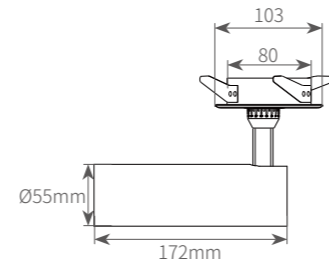

RC55

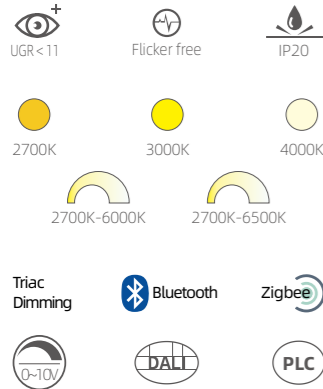

Product information

Power	8W/15W
Beam angle	12°/24°/36°/60°
Input voltage	AC100-240/220-240V
Input frequency	50/60Hz
System Luminous flux	82lm/W
CRI	>90
Finish color	Sand white / sand black

Product performance

Saturation red reduction degree	R9=90
Color Accuracy	Rf≥92
Color Saturation	Rg=99
Color tolerance	SDCM<3
Light Fixture Material	Aluminium
Installation	Recessed

Light distribution parameters

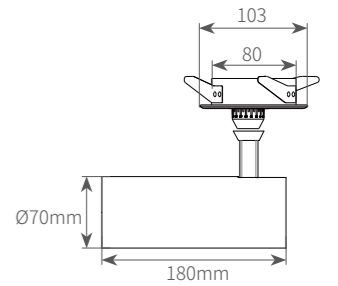
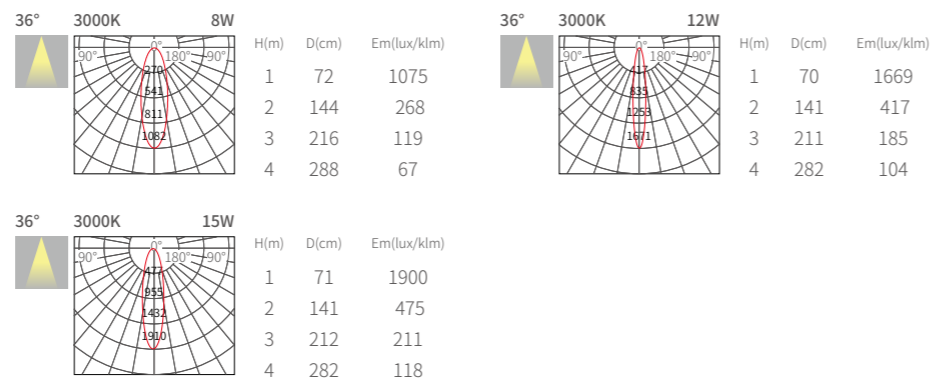

RC69

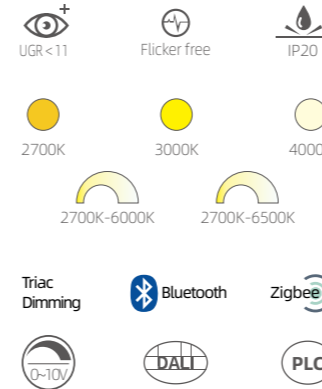

Product information

Power	8W/15W/20W/25W
Beam angle	12°/24°/36°/60°
Input voltage	AC100-240/220-240V
Input frequency	50/60Hz
System Luminous flux	95lm/W
CRI	>90
Finish color	Sand white / sand black

Product performance

Saturation red reduction degree	R9=90
Color Accuracy	Rf≥92
Color Saturation	Rg=99
Color tolerance	SDCM<3
Light Fixture Material	Aluminium
Installation	Recessed

Light distribution parameters

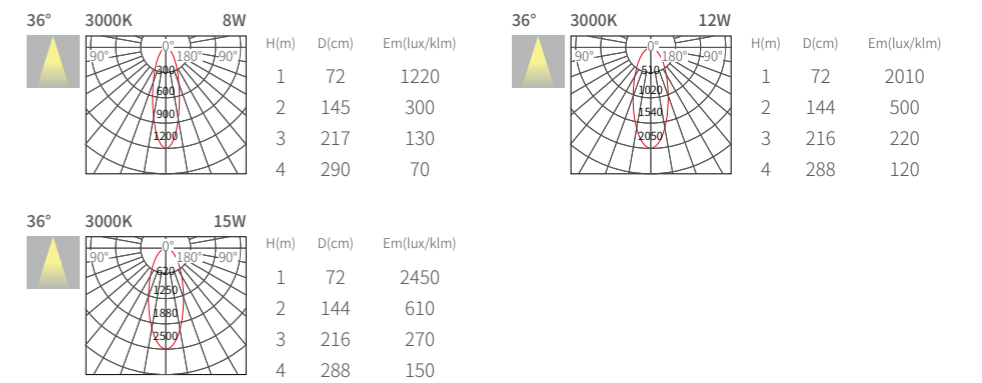

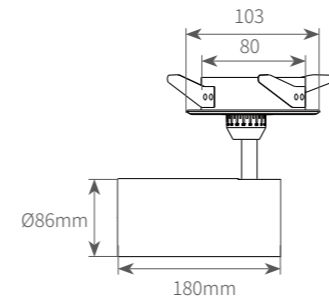

RC86

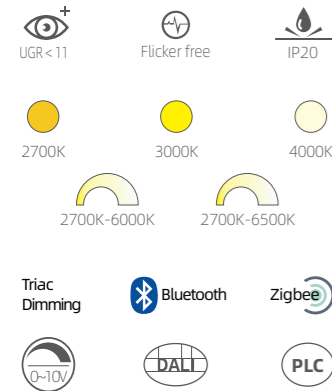

Product information

Power	30W/35W
Beam angle	12°/24°/36°/60°
Input voltage	AC100-240/220-240V
Input frequency	50/60Hz
System Luminous flux	80lm/W
CRI	>90
Finish color	Sand white / sand black

Product performance

Saturation red reduction degree	R9=90
Color Accuracy	Rf≥92
Color Saturation	Rg=99
Color tolerance	SDCM<3
Light Fixture Material	Aluminium
Installation	Recessed

Light distribution parameters

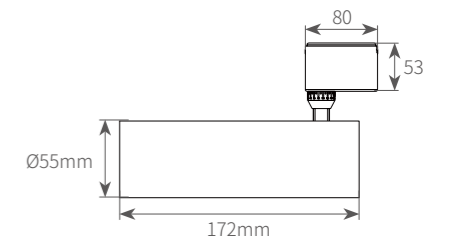
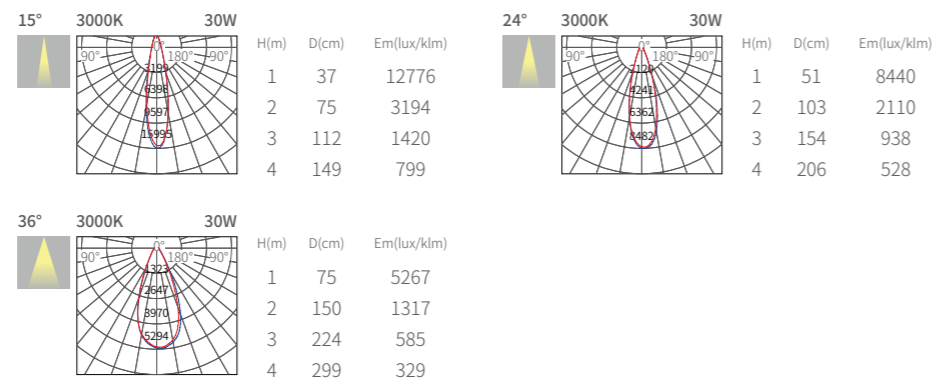

RM55

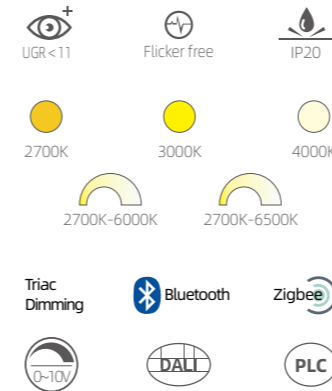

Product information

Power	8W/15W
Beam angle	12°/24°/36°/60°
Input voltage	AC100-240/220-240V
Input frequency	50/60Hz
System Luminous flux	82lm/W
CRI	>90
Finish color	Sand white / sand black

Product performance

Saturation red reduction degree	R9=90
Color Accuracy	Rf≥92
Color Saturation	Rg=99
Color tolerance	SDCM<3
Light Fixture Material	Aluminium
Installation	Surface Mounted

Light distribution parameters

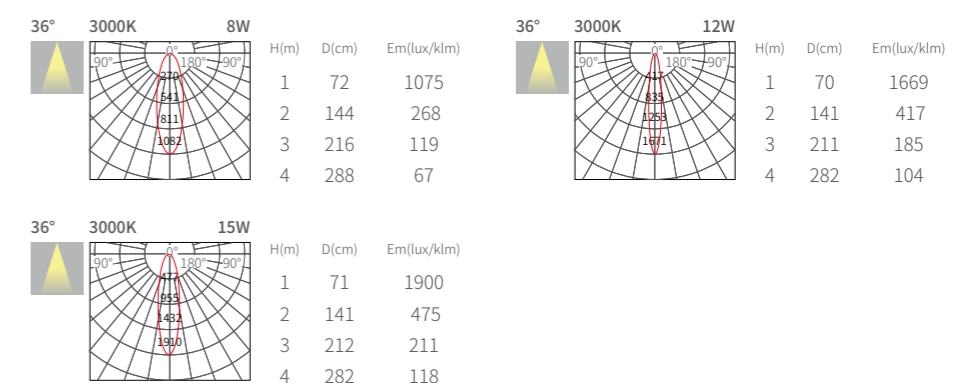

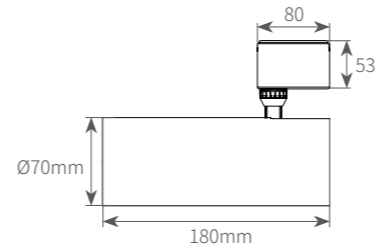

RM69

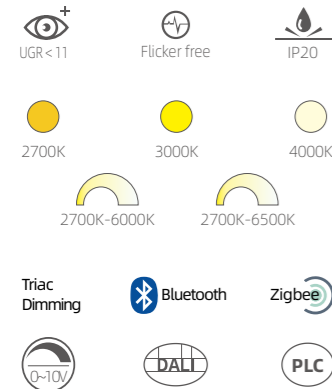

Product information

Power	8W/15W/20W/25W
Beam angle	12°/24°/36°/60°
Input voltage	AC100-240/220-240V
Input frequency	50/60Hz
System Luminous flux	95lm/W
CRI	>90
Finish color	Sand white / sand black

Product performance

Saturation red reduction degree	R9=90
Color Accuracy	Rf≥92
Color Saturation	Rg=99
Color tolerance	SDCM<3
Light Fixture Material	Aluminium
Installation	Surface Mounted

Light distribution parameters

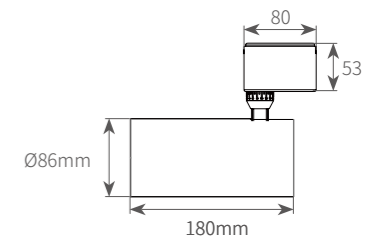
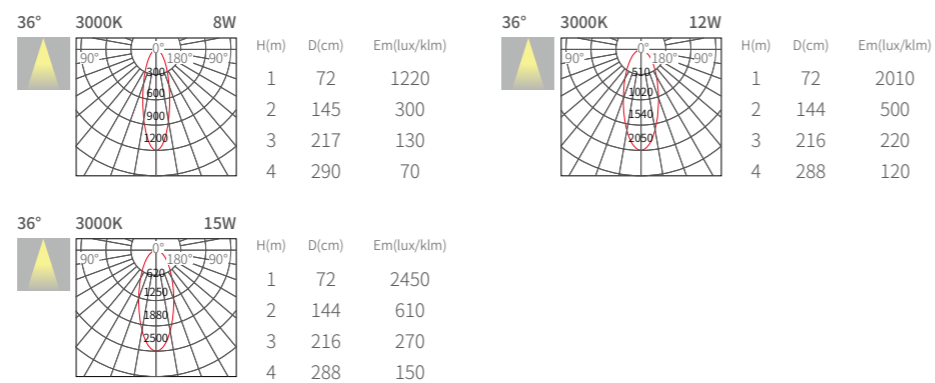

RM86

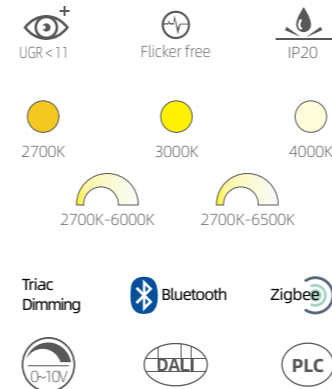

Product information

Power	30W/35W
Beam angle	12°/24°/36°/60°
Input voltage	AC100-240/220-240V
Input frequency	50/60Hz
System Luminous flux	80lm/W
CRI	>90
Finish color	Sand white / sand black

Product performance

Saturation red reduction degree	R9=90
Color Accuracy	Rf≥92
Color Saturation	Rg=99
Color tolerance	SDCM<3
Light Fixture Material	Aluminium
Installation	Surface Mounted

Light distribution parameters

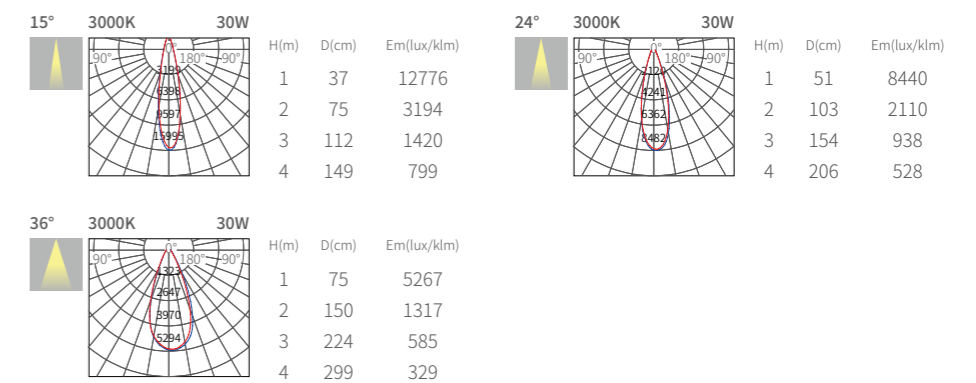

PULL OUT SPOTLIGHT
SERIES



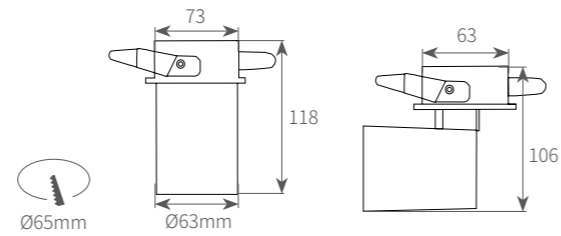

PORC7312

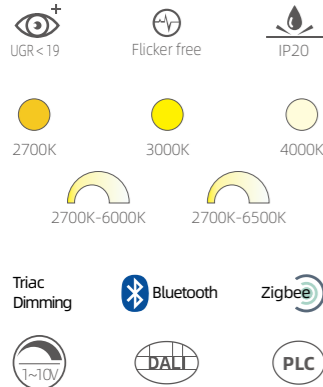

Product information

Power	12W
Beam angle	(Lens) : 12°/24°/36° (Reflector): 15°/24°/38°/60°
Input voltage	AC100-240/220-240V
Input frequency	50/60Hz
System Luminous flux	98lm/W
CRI	Ra > 90
Finish color	white/black

Product performance

Saturation red reduction degree	R9=90
Color Accuracy	Rf ≥ 92
Color Saturation	Rg=99
Color tolerance	SDCM < 3
Light Fixture Material	Aluminium
Installation	Recessed

Light distribution parameters

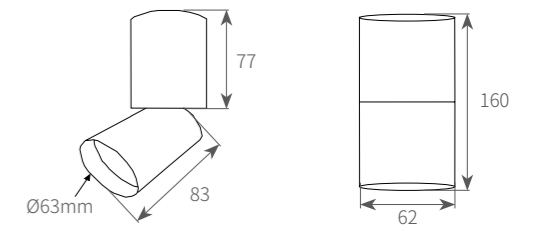
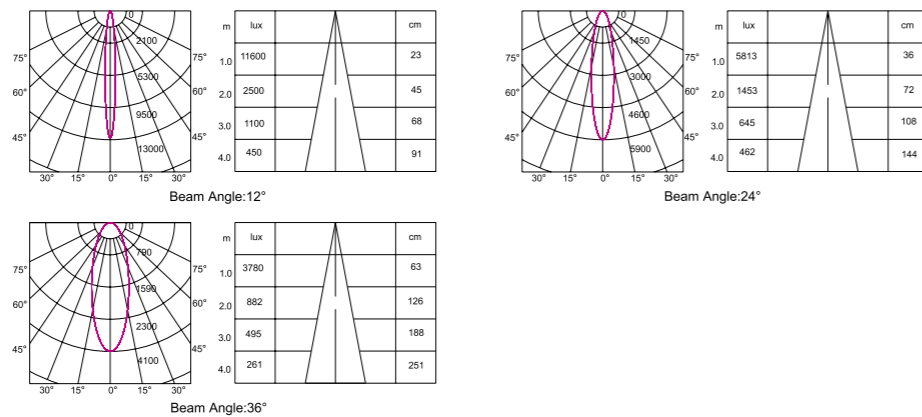

PORM6212

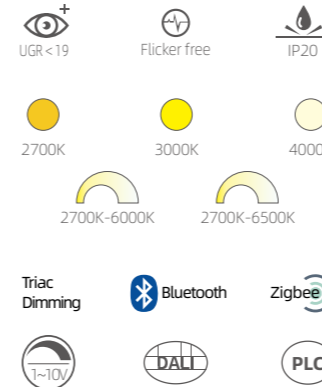

Product information

Power	12W
Beam angle	(Lens) : 12°/24°/36° (Reflector): 15°/24°/38°/60°
Input voltage	AC100-240/220-240V
Input frequency	50/60Hz
System Luminous flux	98lm/W
CRI	Ra > 90
Finish color	white/black

Product performance

Saturation red reduction degree	R9=90
Color Accuracy	Rf ≥ 92
Color Saturation	Rg=99
Color tolerance	SDCM < 3
Light Fixture Material	Aluminium
Installation	Surface Mounted

Light distribution parameters

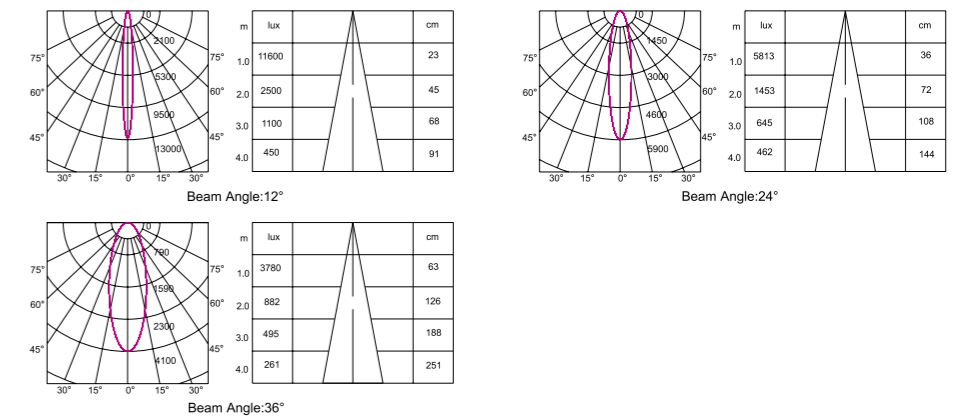

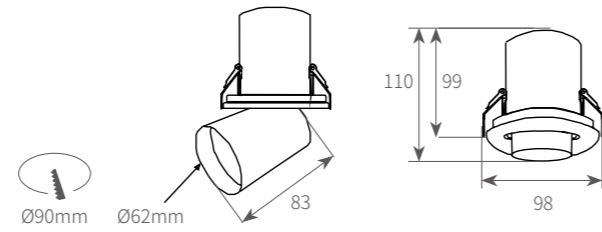

POR9812

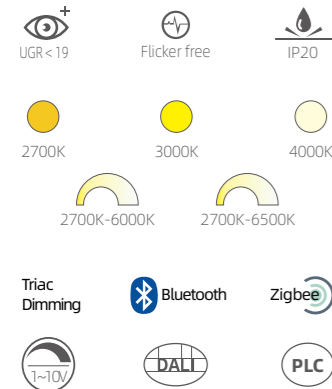

Product information

Power	12W
Beam angle	(Lens) : 12°/24°/36° (Reflector): 15°/24°/38°/60°
Input voltage	AC100-240/220-240V
Input frequency	50/60Hz
System Luminous flux	98lm/W
CRI	Ra>90
Finish color	white/black

Product performance

Saturation red reduction degree	R9=90
Color Accuracy	Rf≥92
Color Saturation	Rg=99
Color tolerance	SDCM<3
Light Fixture Material	Aluminium
Installation	Recessed

Light distribution parameters

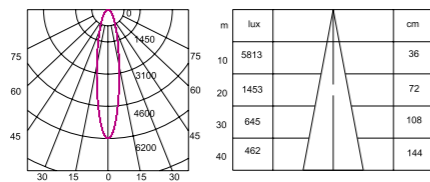

12W 24°3000K CRI>90

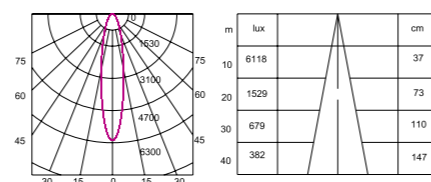

12W 24°4000K CRI>90

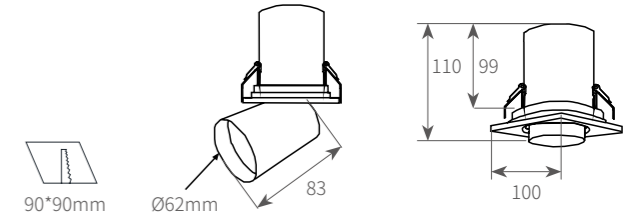

POS10012

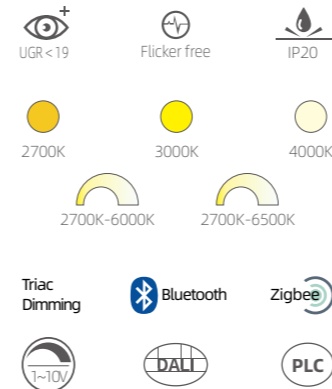

Product information

Power	12W
Beam angle	(Lens) : 12°/24°/36° (Reflector): 15°/24°/38°/60°
Input voltage	AC100-240/220-240V
Input frequency	50/60Hz
System Luminous flux	95lm/W
CRI	Ra>90
Finish color	white/black

Product performance

Saturation red reduction degree	R9=90
Color Accuracy	Rf≥92
Color Saturation	Rg=99
Color tolerance	SDCM<3
Light Fixture Material	Aluminium
Installation	Recessed

Light distribution parameters

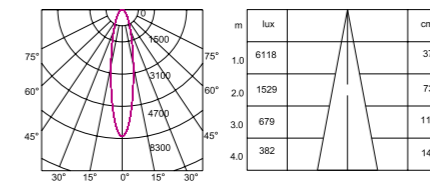

12W 24°3000K CRI>90

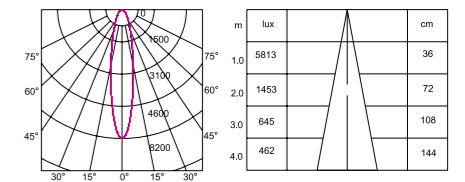

12W 24°4000K CRI>90

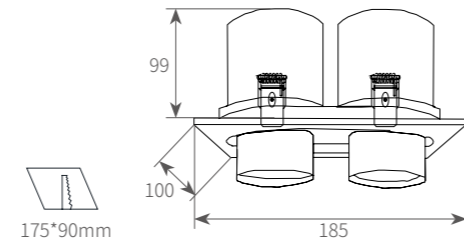

POD100-2*12

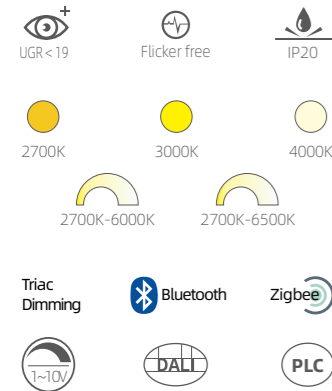

Product information

Power	2*12W
Beam angle	(Lens) : 12°/24°/36° (Reflector): 15°/24°/38°/60°
Input voltage	AC100-240/220-240V
Input frequency	50/60Hz
System Luminous flux	120lm/W
CRI	Ra>90
Finish color	white/black

Product performance

Saturation red reduction degree	R9=90
Color Accuracy	Rf≥92
Color Saturation	Rg=99
Color tolerance	SDCM<3
Light Fixture Material	Aluminium
Installation	Recessed

Light distribution parameters

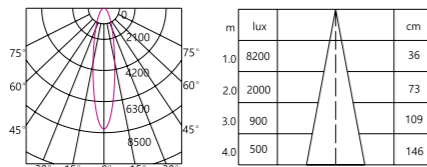

2*12W 24°3000K CRI>90

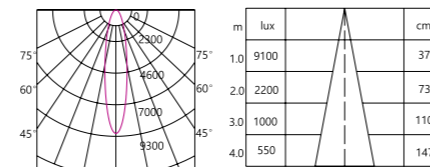

2*12W 24°4000K CRI>90

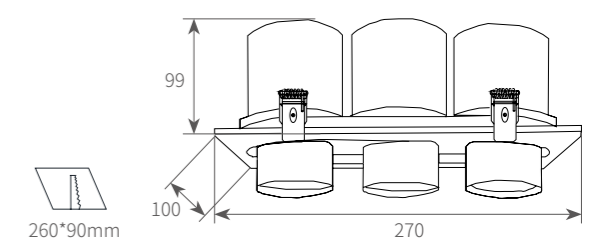

POT100-3*12

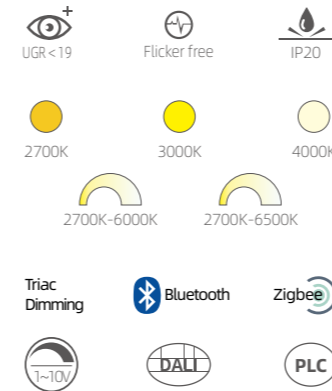

Product information

Power	3*12W
Beam angle	(Lens) : 12°/24°/36° (Reflector): 15°/24°/38°/60°
Input voltage	AC100-240/220-240V
Input frequency	50/60Hz
System Luminous flux	97lm/W
CRI	Ra>90
Finish color	white/black

Product performance

Saturation red reduction degree	R9=90
Color Accuracy	Rf≥92
Color Saturation	Rg=99
Color tolerance	SDCM<3
Light Fixture Material	Aluminium
Installation	Recessed

Light distribution parameters

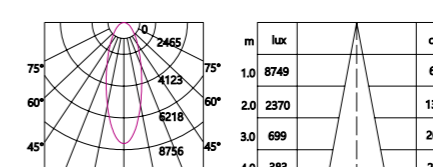

3*12W 36°2700K CRI>90

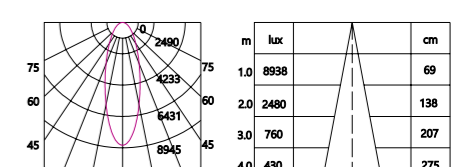

3*12W 36°3000K CRI>90

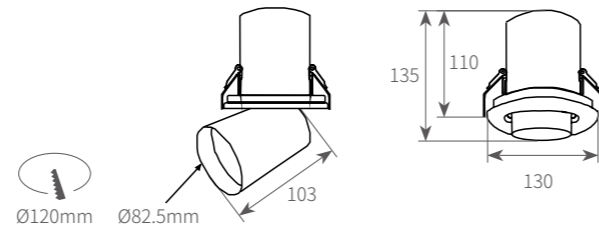

POR13025

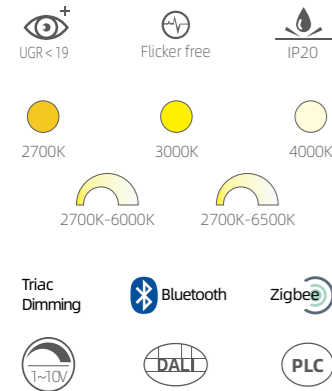

Product information

Power	25W
Beam angle	15°/24°/36°
Input voltage	AC100-240/220-240V
Input frequency	50/60Hz
System Luminous flux	94lm/W
CRI	Ra>90
Finish color	white/black

Product performance

Saturation red reduction degree	R9=90
Color Accuracy	Rf≥92
Color Saturation	Rg=99
Color tolerance	SDCM<3
Light Fixture Material	Aluminium
Installation	Recessed

Light distribution parameters

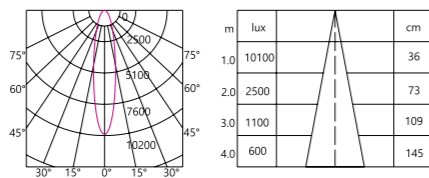

25W 24°2700K CRI>90

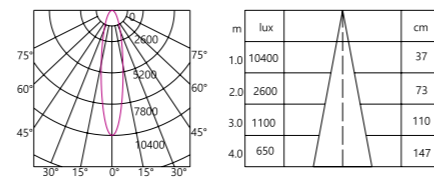

25W 24°3000K CRI>90

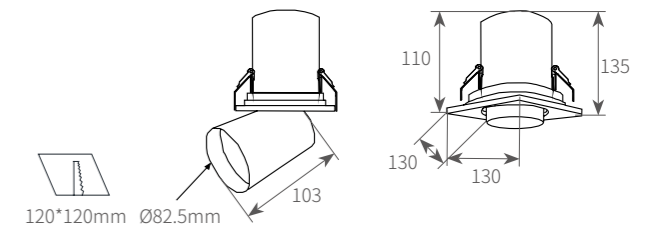

POS13025

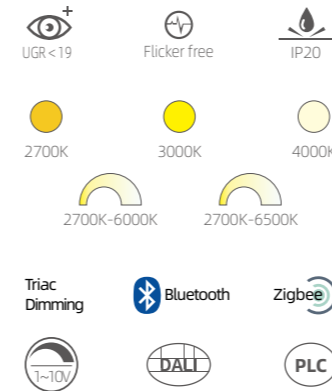

Product information

Power	25W
Beam angle	15°/24°/36°
Input voltage	AC100-240/220-240V
Input frequency	50/60Hz
System Luminous flux	98lm/W
CRI	Ra>90
Finish color	white/black

Product performance

Saturation red reduction degree	R9=90
Color Accuracy	Rf≥92
Color Saturation	Rg=99
Color tolerance	SDCM<3
Light Fixture Material	Aluminium
Installation	Recessed

Light distribution parameters

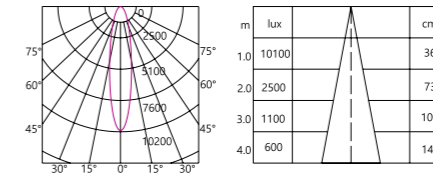

25W 24°2700K CRI>90

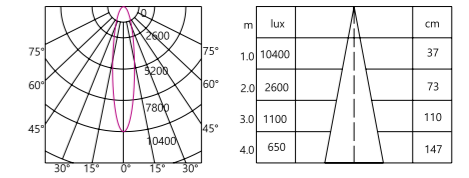

25W 24°3000K CRI>90

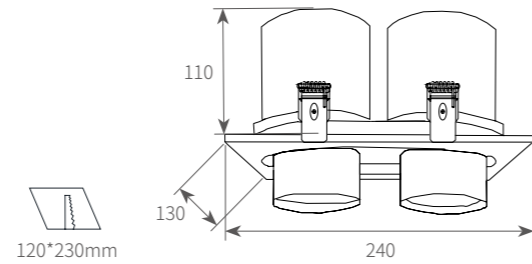

POD130-2*25

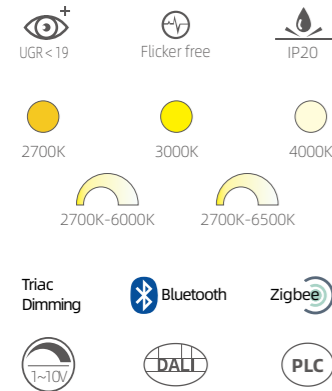

Product information

Power	2*25W
Beam angle	15°/24°/36°
Input voltage	AC100-240/220-240V
Input frequency	50/60Hz
System Luminous flux	103lm/W
CRI	Ra>90
Finish color	white/black

Product performance

Saturation red reduction degree	R9=90
Color Accuracy	Rf≥92
Color Saturation	Rg=99
Color tolerance	SDCM<3
Light Fixture Material	Aluminium
Installation	Recessed

Light distribution parameters

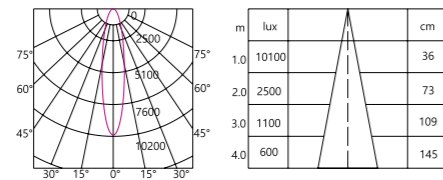

2*25W 24°2700K CRI>90

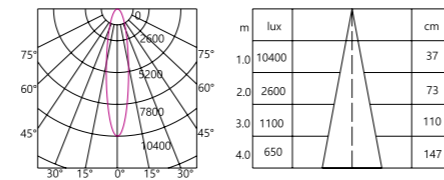

2*25W 24°3000K CRI>90

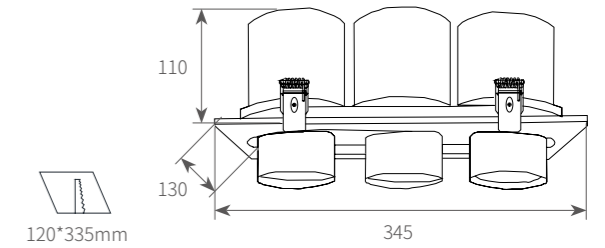

POT130-3*25

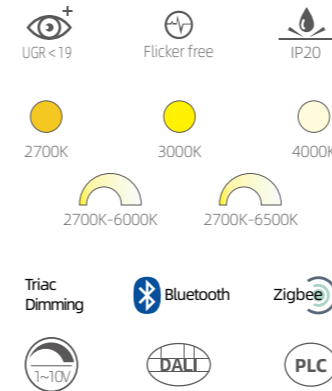

Product information

Power	3*25W
Beam angle	15°/24°/36°
Input voltage	AC100-240/220-240V
Input frequency	50/60Hz
System Luminous flux	91lm/W
CRI	Ra>90
Finish color	white/black

Product performance

Saturation red reduction degree	R9=90
Color Accuracy	Rf≥92
Color Saturation	Rg=99
Color tolerance	SDCM<3
Light Fixture Material	Aluminium
Installation	Recessed

Light distribution parameters

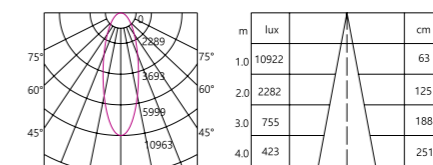

3*25W 36°2700K CRI>90

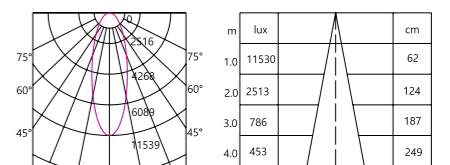

3*25W 36°3000K CRI>90

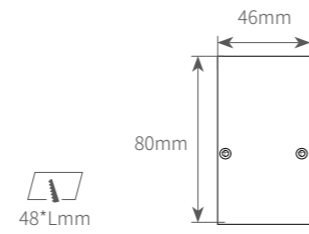

RC500 / RC1000 / RC1500 / RC2000

Product information

Power	384W Max
Beam angle	/
Input voltage	DC24V
Input frequency	/
System Luminous flux	/
CRI	/
Finish color	Black

Product performance

Saturation red reduction degree	/
Color Accuracy	/
Color Saturation	/
Color tolerance	/
Light Fixture Material	Aluminum + Copper
Installation	Recessed

Accessories

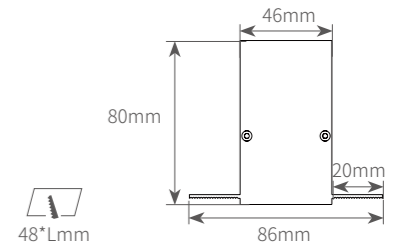
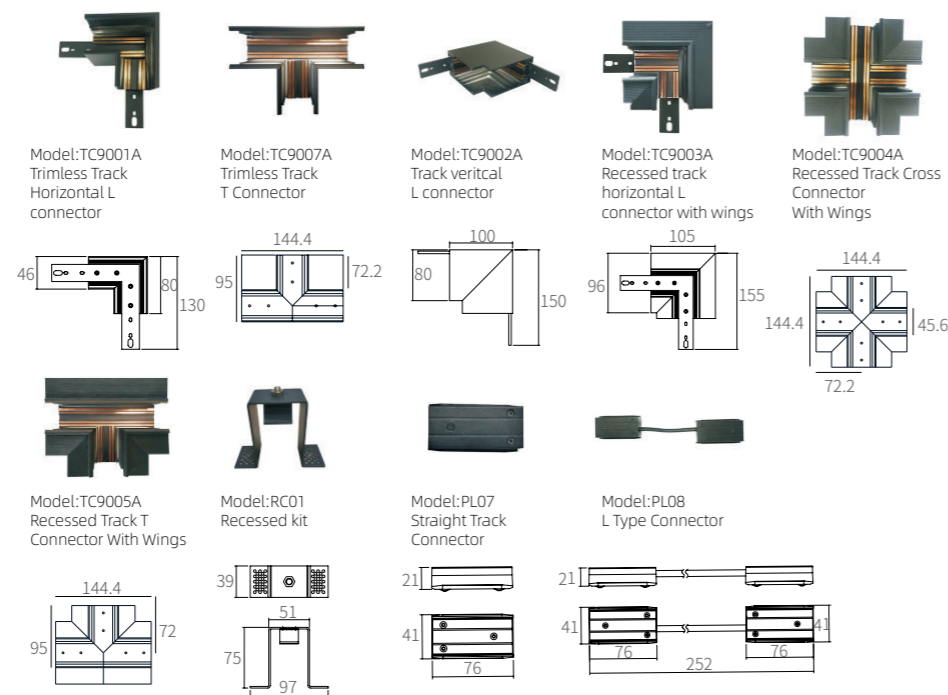

RC500S / RC1000S / RC1500S / RC2000S

Product information

Power	384W Max
Beam angle	/
Input voltage	DC24V
Input frequency	/
System Luminous flux	/
CRI	/
Finish color	Black

Product performance

Saturation red reduction degree	/
Color Accuracy	/
Color Saturation	/
Color tolerance	/
Light Fixture Material	Aluminum + Copper
Installation	Recessed

Accessories

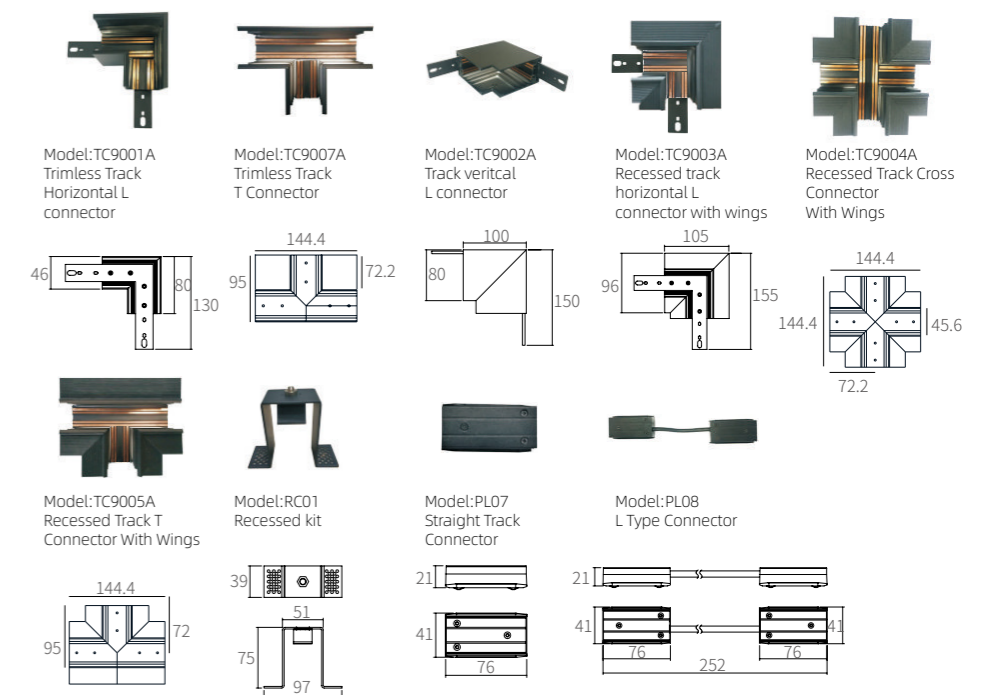

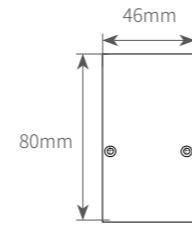
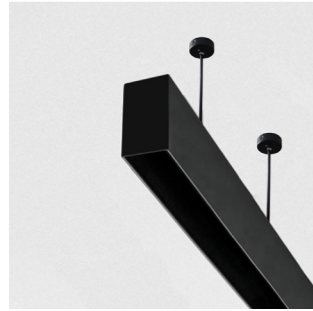

SP500 / SP1000 / SP1500 / SP2000

Product information

Power	384W Max
Beam angle	/
Input voltage	DC24V
Input frequency	/
System Luminous flux	/
CRI	/
Finish color	Black

Product performance

Saturation red reduction degree	/
Color Accuracy	/
Color Saturation	/
Color tolerance	/
Light Fixture Material	Aluminum + Copper
Installation	Pendant

Accessories

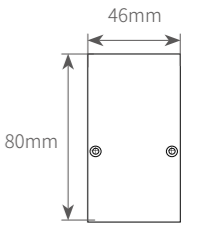
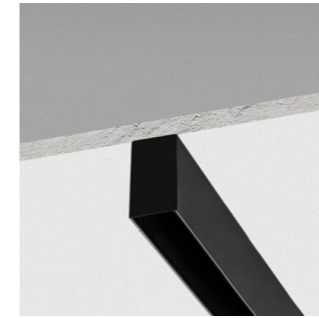
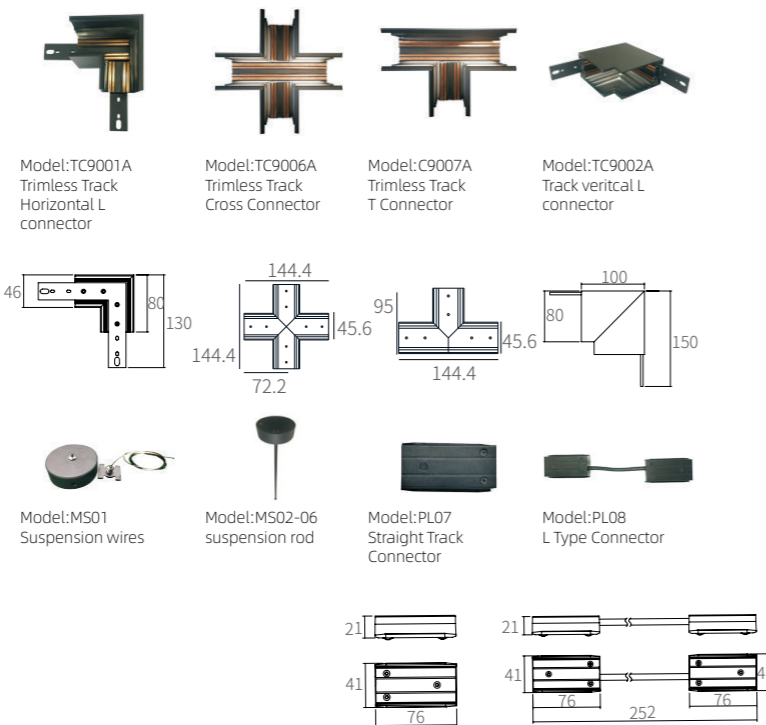

SM500 / SM1000 / SM1500 / SM2000

Product information

Power	384W Max
Beam angle	/
Input voltage	DC24V
Input frequency	/
System Luminous flux	/
CRI	/
Finish color	Black

Product performance

Saturation red reduction degree	/
Color Accuracy	/
Color Saturation	/
Color tolerance	/
Light Fixture Material	Aluminum + Copper
Installation	Surface Mounted

Accessories

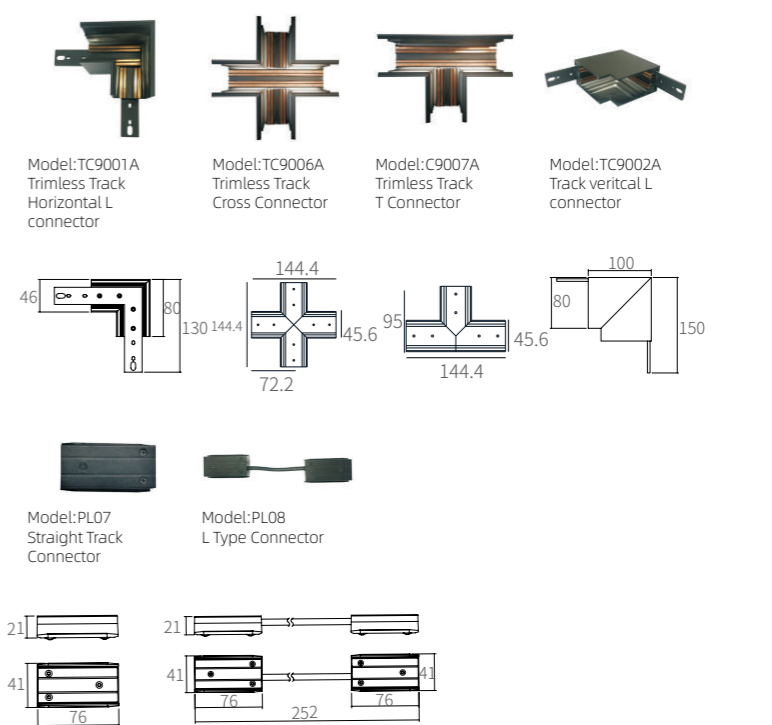

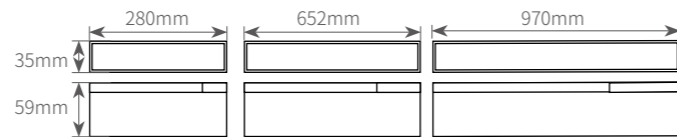

MLL300/MLL640/MLL960

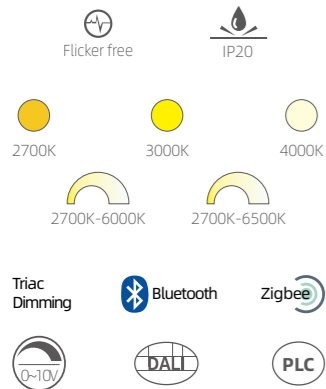

Product information	
Power	10W/20W/30W
Beam angle	110°
Input voltage	DC24V
Input frequency	/
System Luminous flux	90lm/W
CRI	>90
Finish color	Sand white / sand black

Product performance	
Saturation red reduction degree	R9=90
Color Accuracy	Rf≥92
Color Saturation	Rg=99
Color tolerance	SDCM<3
Light Fixture Material	Aluminium
Installation	Track

Light distribution parameters

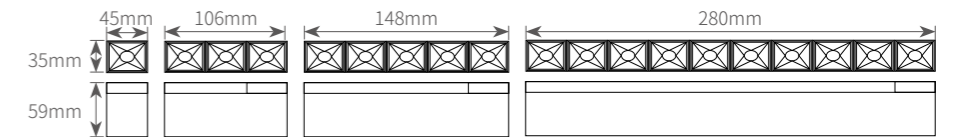
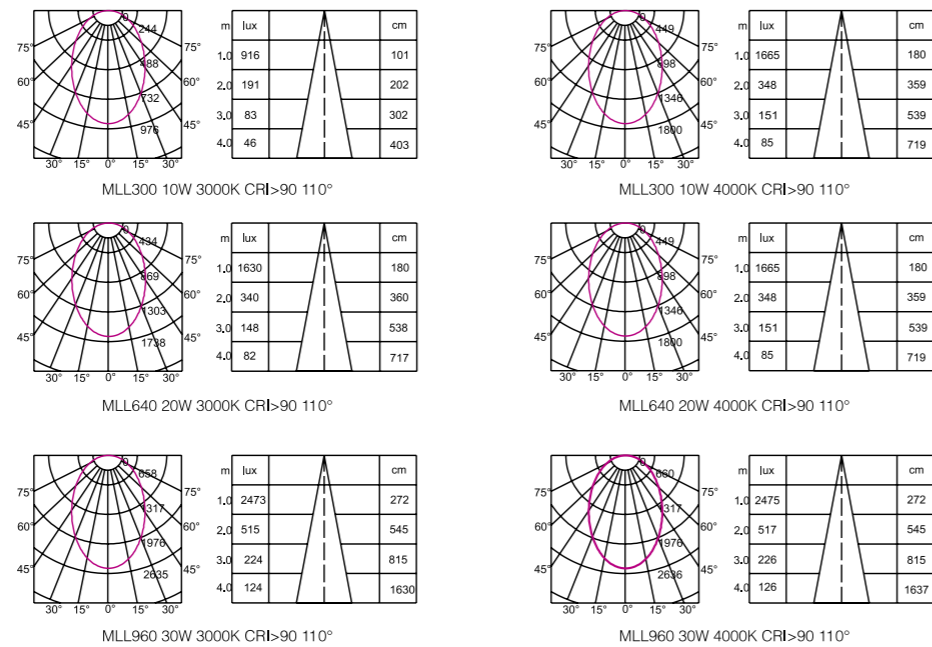

MLS01/MLS03/MLS05/MLS10

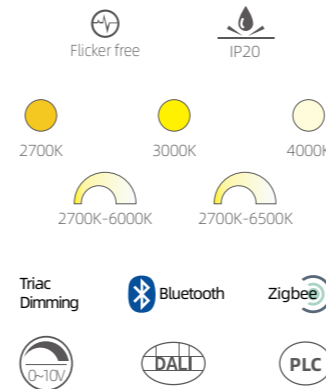

Product information	
Power	1*1W/3*1W/5*1W/10*1W/ 3*2W/5*2W/10*2W
Beam angle	15°/30°/45°
Input voltage	DC24V
Input frequency	/
System Luminous flux	83lm/W
CRI	>90
Finish color	Sand white / sand black

Product performance	
Saturation red reduction degree	R9=90
Color Accuracy	Rf≥92
Color Saturation	Rg=99
Color tolerance	SDCM<3
Light Fixture Material	Aluminium
Installation	Track

Light distribution parameters

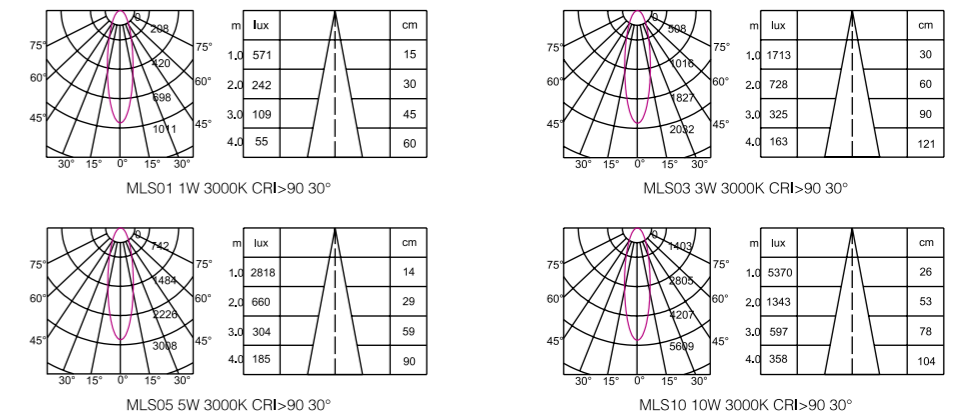

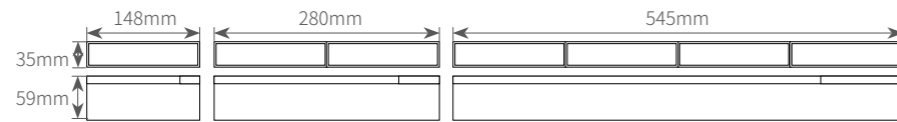

MW05/MW10/MW20

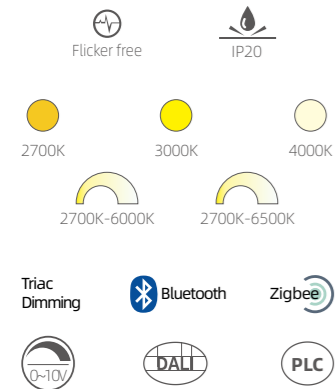

Product information	
Power	5W/10W, 10W/20W, 20W/30W
Beam angle	90°
Input voltage	DC24V
Input frequency	/
System Luminous flux	80lm/W
CRI	>90
Finish color	Sand white / sand black

Product performance	
Saturation red reduction degree	R9=90
Color Accuracy	Rf≥92
Color Saturation	Rg=99
Color tolerance	SDCM<3
Light Fixture Material	Aluminium
Installation	Track

Light distribution parameters

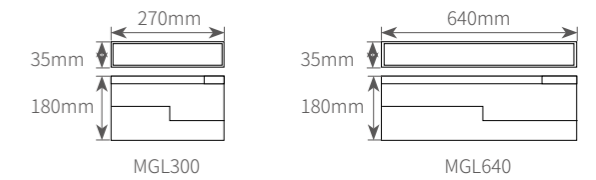
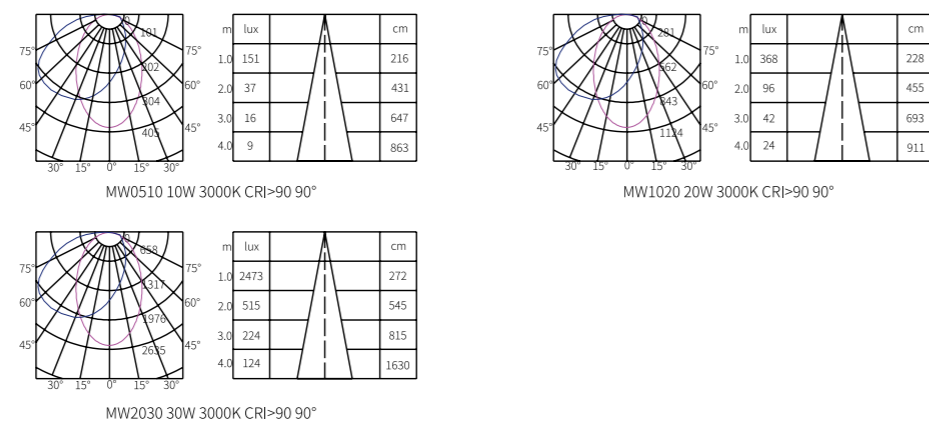

MGL300/MGL640

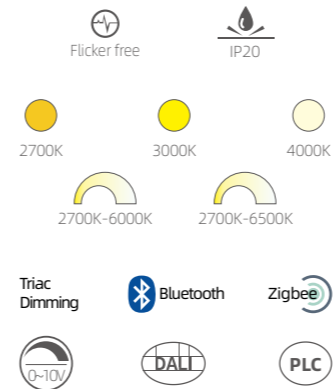

Product information	
Power	10W/20W
Beam angle	120°
Input voltage	DC24V
Input frequency	/
System Luminous flux	103lm/W
CRI	>90
Finish color	Sand white / sand black

Product performance	
Saturation red reduction degree	R9=90
Color Accuracy	Rf≥92
Color Saturation	Rg=99
Color tolerance	SDCM<3
Light Fixture Material	Aluminium
Installation	Track

Light distribution parameters

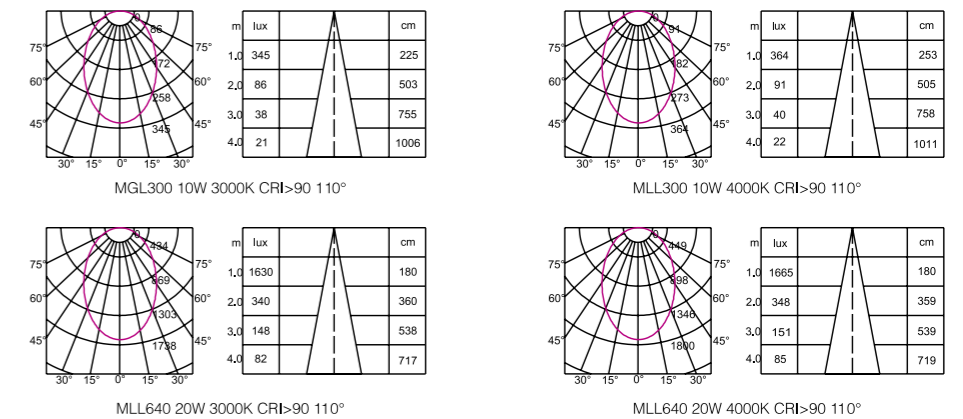

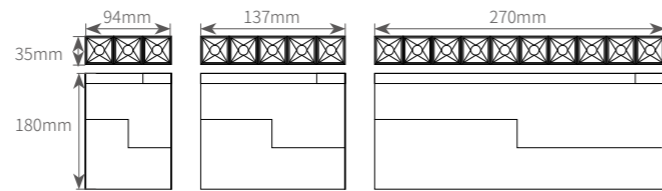

MGS03/MGS05/MGS10

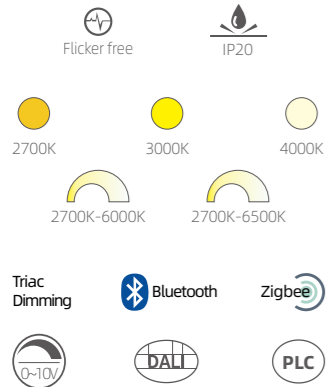

Product information	
Power	3W/6W,5W/10W,10W/20W
Beam angle	15°/30°/45°
Input voltage	DC24V
Input frequency	/
System Luminous flux	83lm/W
CRI	>90
Finish color	Sand white / sand black

Product performance	
Saturation red reduction degree	R9=90
Color Accuracy	Rf≥92
Color Saturation	Rg=99
Color tolerance	SDCM<3
Light Fixture Material	Aluminium
Installation	Track

Light distribution parameters

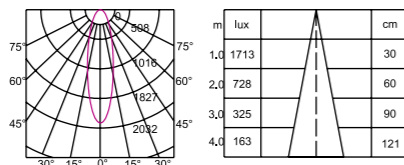

MLS03 3W 3000K CRI>90 30°

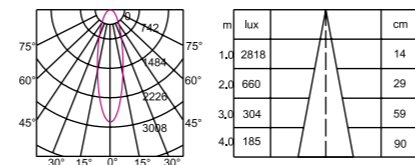

MLS05 5W 3000K CRI>90 30°



MLS10 10W 3000K CRI>90 30°

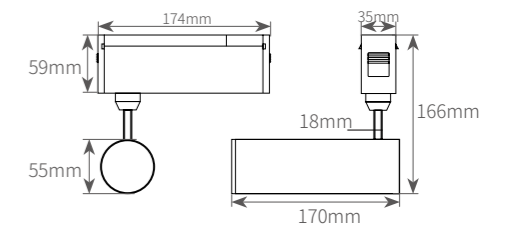

MS55

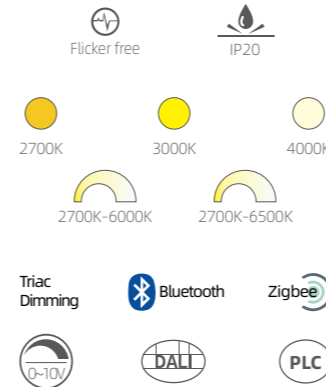

Product information	
Power	8W/15W
Beam angle	15°/24°/36°
Input voltage	DC24V
Input frequency	/
System Luminous flux	82lm/W
CRI	>90
Finish color	Sand white / sand black

Product performance	
Saturation red reduction degree	R9=90
Color Accuracy	Rf≥92
Color Saturation	Rg=99
Color tolerance	SDCM<3
Light Fixture Material	Aluminium
Installation	Track

Light distribution parameters

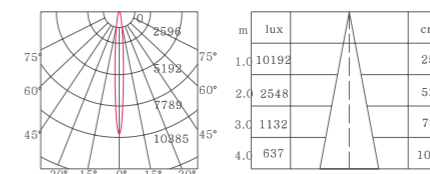

Beam Angle=15°

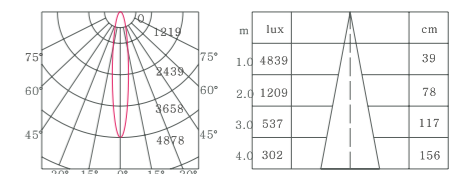

Beam Angle=24°

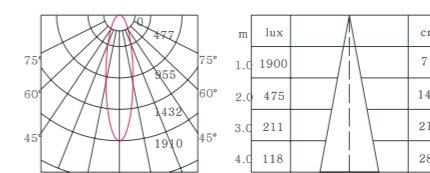

Beam Angle=36°

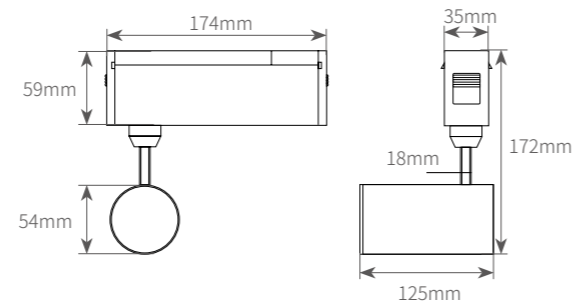

MS54

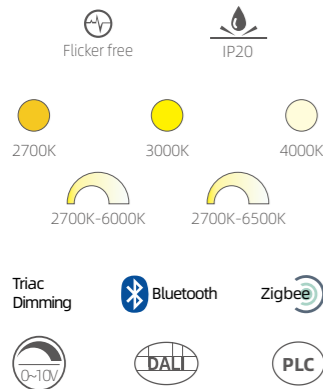

Product information

Power	15W
Beam angle	15°/24°/36°
Input voltage	DC24V
Input frequency	/
System Luminous flux	90lm/W
CRI	>90
Finish color	Sand white / Sand black

Product performance

Saturation red reduction degree	R9=90
Color Accuracy	Rf≥92
Color Saturation	Rg=99
Color tolerance	SDCM<3
Light Fixture Material	Aluminium
Installation	Track

Light distribution parameters

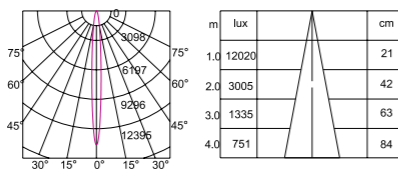

MS54 15W 3000K CRI>90 15°

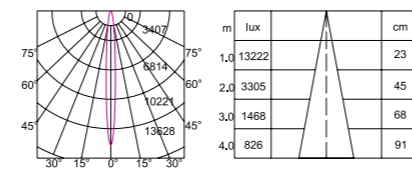

MS54 15W 4000K CRI>90 15°

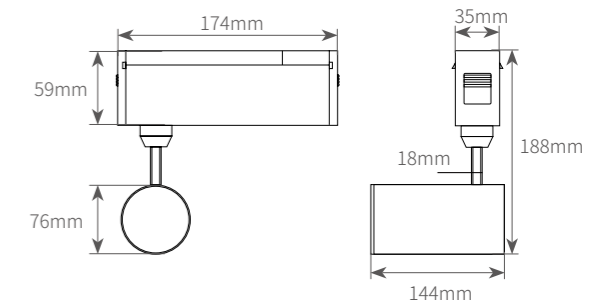

MS76

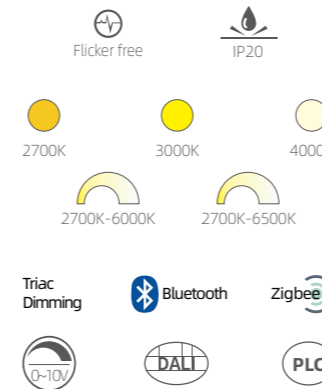

Product information

Power	15W/20W/25W
Beam angle	15°/24°/36°
Input voltage	DC24V
Input frequency	/
System Luminous flux	82lm/W
CRI	>90
Finish color	Sand white / Sand black

Product performance

Saturation red reduction degree	R9=90
Color Accuracy	Rf≥92
Color Saturation	Rg=99
Color tolerance	SDCM<3
Light Fixture Material	Aluminium
Installation	Track

Light distribution parameters

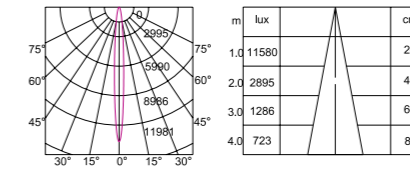

MS76 15W 3000K CRI>90 15°

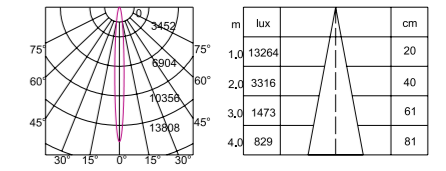

MS76 15W 4000K CRI>90 15°

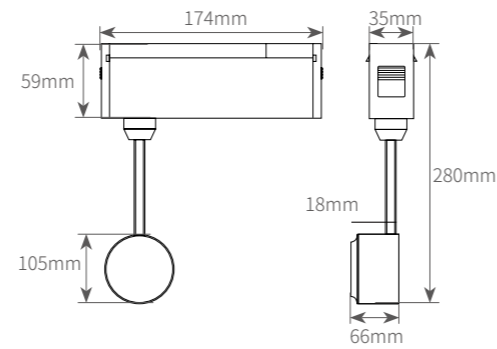

MS112

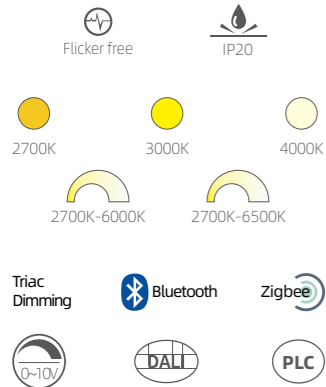

Product information

Power	15W/20W/25W/30W
Beam angle	15°/24°/36°
Input voltage	DC24V
Input frequency	/
System Luminous flux	86lm/W
CRI	>90
Finish color	Sand white / Sand black

Product performance

Saturation red reduction degree	R9=90
Color Accuracy	Rf≥92
Color Saturation	Rg=99
Color tolerance	SDCM<3
Light Fixture Material	Aluminium
Installation	Track

Light distribution parameters

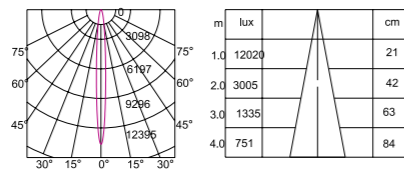

MS112 15W 3000K CRI>90 15°

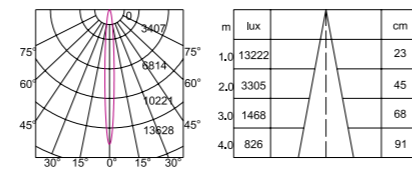

MS112 15W 4000K CRI>90 15°

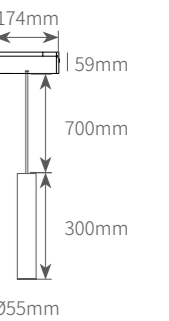

MP55

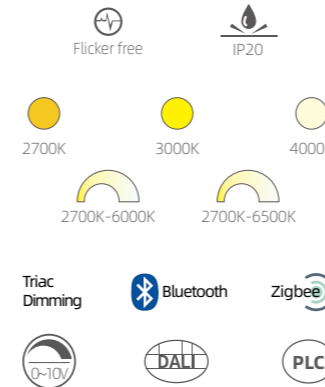

Product information

Power	8W/15W
Beam angle	15°/24°/36°
Input voltage	DC24V
Input frequency	/
System Luminous flux	80lm/W
CRI	>90
Finish color	Sand white / Sand black

Product performance

Saturation red reduction degree	R9=90
Color Accuracy	Rf≥92
Color Saturation	Rg=99
Color tolerance	SDCM<3
Light Fixture Material	Aluminium
Installation	Track

Light distribution parameters

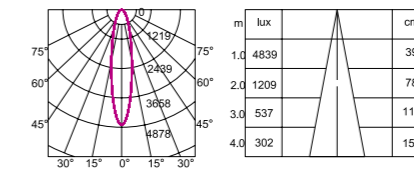

MP55 15W 3000K CRI>90 24°

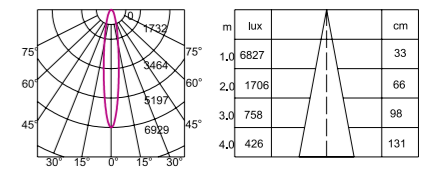

MP55 15W 4000K CRI>90 24°

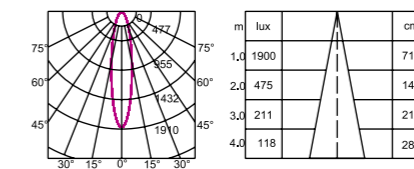

MP55 15W 3000K CRI>90 36°

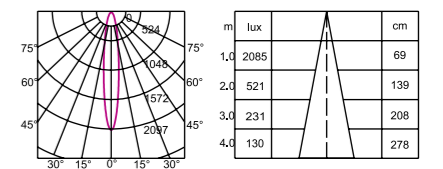

MP55 15W 4000K CRI>90 36°

MAGNETIC TRACK LIGHTING SYSTEM

INTRODUCTION TO MAGNETIC TRACK LIGHT SYSTEM

The magnetic track lighting system are composed of track system and magnetic lamps. It can be combined by DIY, and adjust the lamp modules according to the needs of the application scene. That not only meet individual needs, but also fully demonstrate technology and fashion. Using safe low-voltage DC24V/48V centralized power supply, the unique electrical scheme is compatible with multi-brand intelligent control systems, realizing whole-house control by intelligent voice, panel, mobile APP, remote. Modular lamps includes flood linear lamp, accent linear lamp, gimbal lamp, high power spotlight, suspended lamp etc., to meet different lighting needs. Application: villas, large flats, clubs, exhibition spaces, commercial offices, etc.

Pluggable power supply



Various specifications

According to the customer's requirements, it can be cut into different lengths and matched with different shapes to reflect different lighting effects.
All products are available in pendant, surface mount and recessed mount versions.

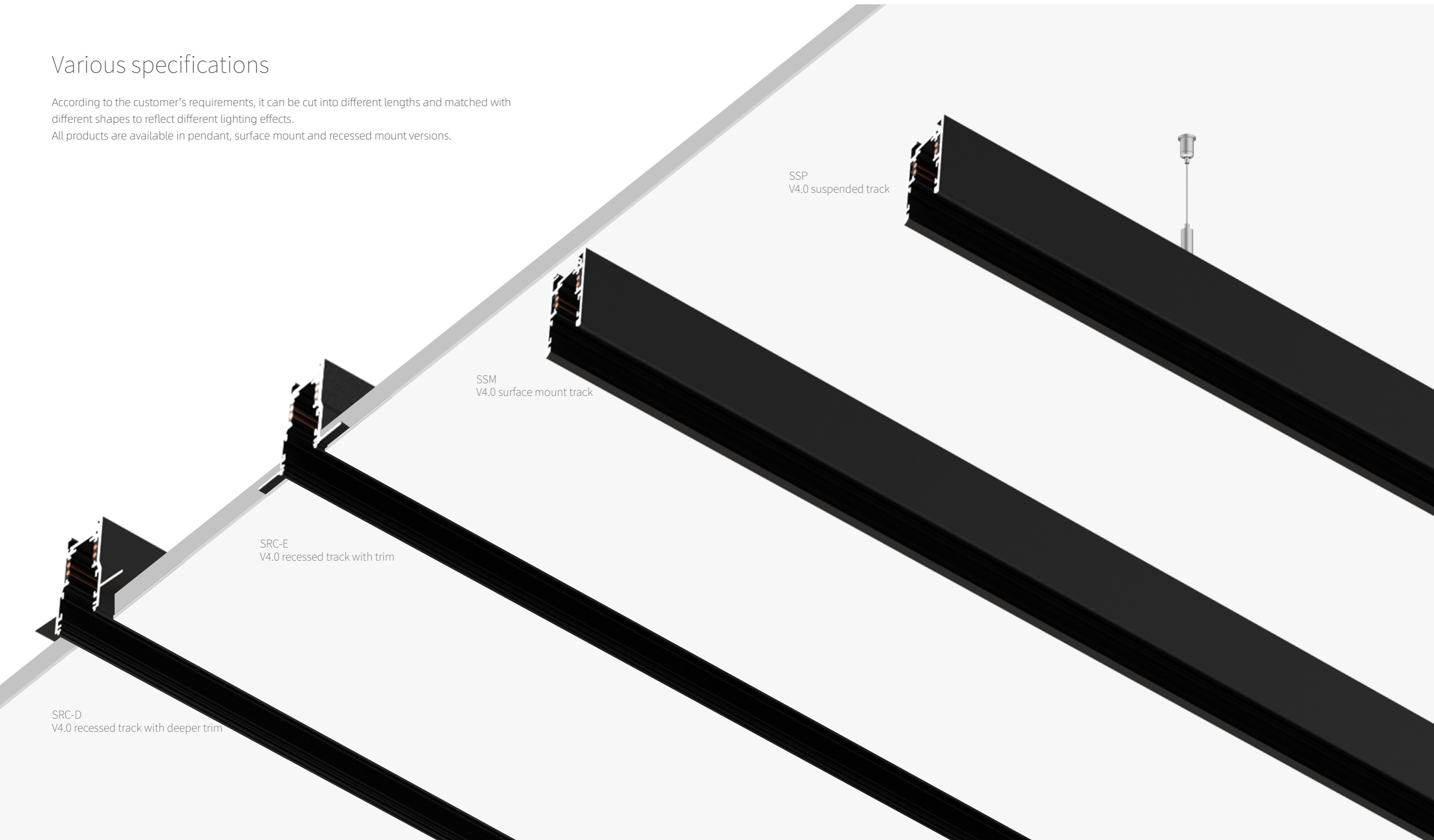

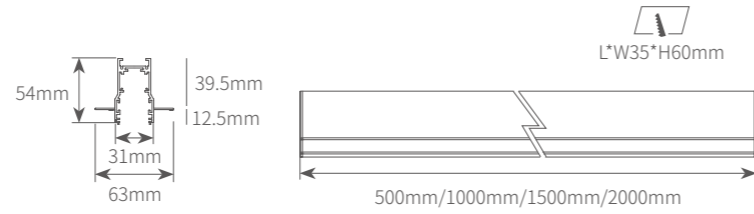

SRC-D

Product information

Power	768W Max
Beam angle	/
Input voltage	24/48V
Input frequency	/
System Luminous flux	/
CRI	/
Finish color	Sand white / sand black

Product performance

Saturation red reduction degree	/
Color Accuracy	/
Color Saturation	/
Color tolerance	/
Light Fixture Material	Aluminium
Installation	Recessed

Accessories

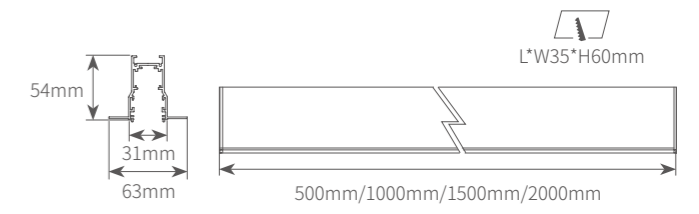
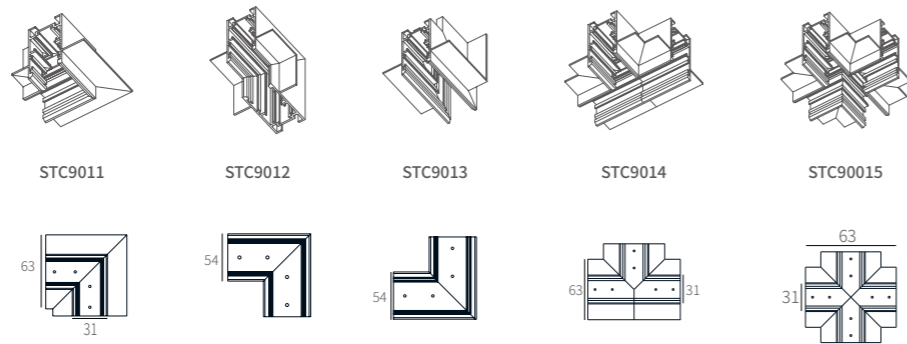

SRC-E

Product information

Power	768W Max
Beam angle	/
Input voltage	24/48V
Input frequency	/
System Luminous flux	/
CRI	/
Finish color	Sand white / sand black

Product performance

Saturation red reduction degree	/
Color Accuracy	/
Color Saturation	/
Color tolerance	/
Light Fixture Material	Aluminium
Installation	Recessed

Accessories

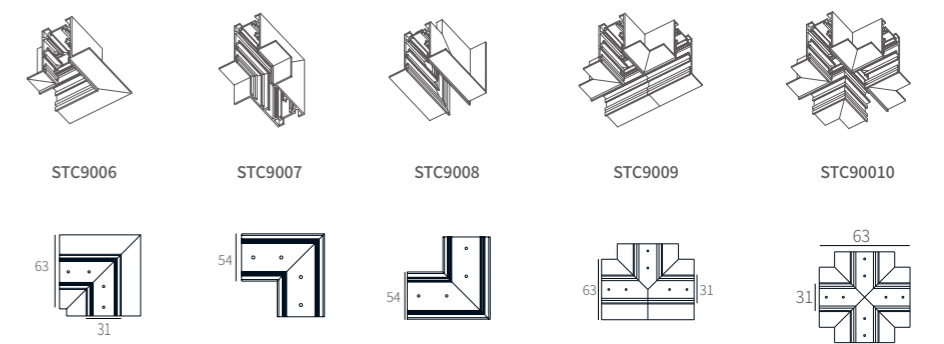



SSM-D

Product information

Power	768W Max
Beam angle	/
Input voltage	24/48V
Input frequency	/
System Luminous flux	/
CRI	/
Finish color	Sand white / sand black

Product performance

Saturation red reduction degree	/
Color Accuracy	/
Color Saturation	/
Color tolerance	/
Light Fixture Material	Aluminium
Installation	Surface Mounted

Accessories

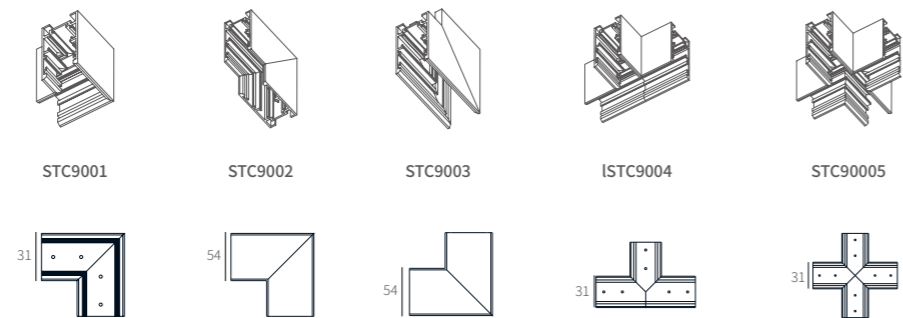

SSP-D

Product information

Power	768W Max
Beam angle	/
Input voltage	24/48V
Input frequency	/
System Luminous flux	/
CRI	/
Finish color	Sand white / sand black

Product performance

Saturation red reduction degree	/
Color Accuracy	/
Color Saturation	/
Color tolerance	/
Light Fixture Material	Aluminium
Installation	Pendant

Accessories

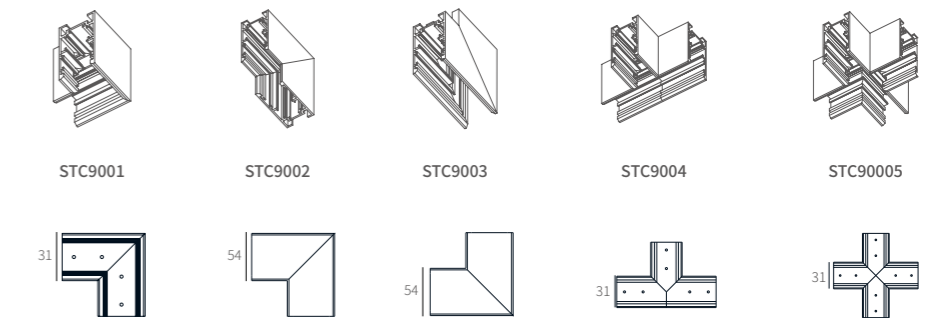

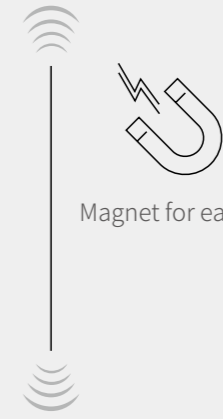

Magnet for easy install and remove

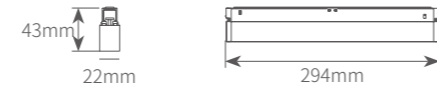

SMLL3007

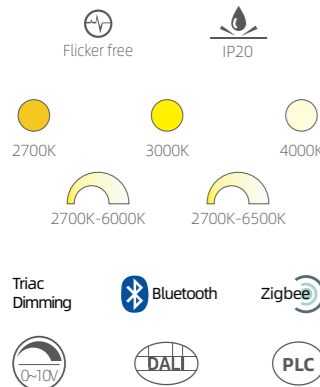

Product information

Power	7W/10W
Beam angle	110°
Input voltage	24/48V
Input frequency	16KHz
System Luminous flux	80Lm/w
CRI	>90/97
Finish color	Sand white / sand black

Product performance

Saturation red reduction degree	R9=90
Color Accuracy	Rf≥92
Color Saturation	Rg=99
Color tolerance	SDCM<3
Light Fixture Material	Aluminium
Installation	Track

Light distribution parameters

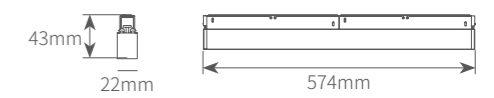
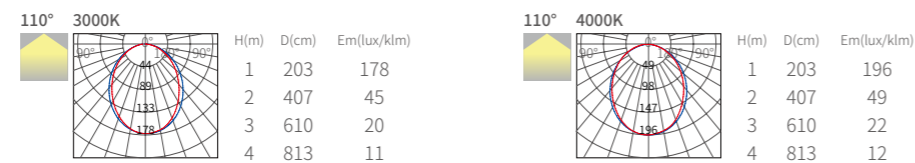

SMLL6015

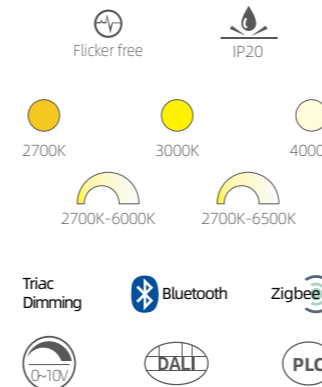

Product information

Power	15W
Beam angle	110°
Input voltage	24/48V
Input frequency	16KHz
System Luminous flux	80Lm/w
CRI	>90/97
Finish color	Sand white / sand black

Product performance

Saturation red reduction degree	R9=90
Color Accuracy	Rf≥92
Color Saturation	Rg=99
Color tolerance	SDCM<3
Light Fixture Material	Aluminium
Installation	Track

Light distribution parameters

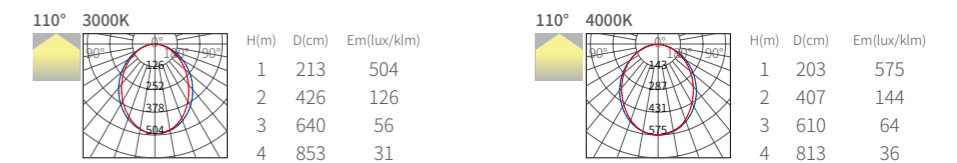

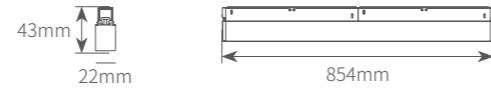

SMLL9022

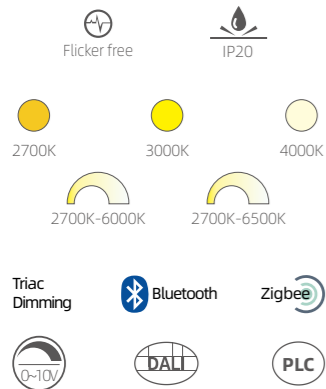

Product information

Power	22W
Beam angle	110°
Input voltage	24/48V
Input frequency	16KHz
System Luminous flux	80Lm/w
CRI	>90/97
Finish color	Sand white / sand black

Product performance

Saturation red reduction degree	R9=90
Color Accuracy	Rf≥92
Color Saturation	Rg=99
Color tolerance	SDCM<3
Light Fixture Material	Aluminium
Installation	Track

Light distribution parameters

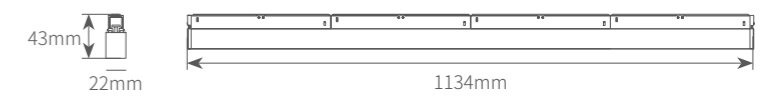
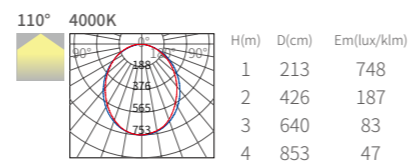
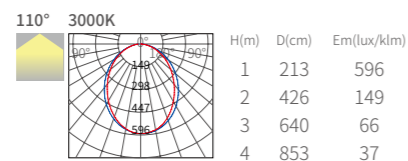

SMLL12030

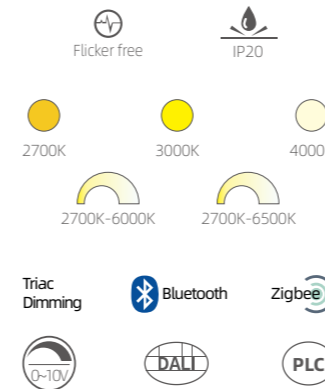

Product information

Power	30W
Beam angle	110°
Input voltage	24/48V
Input frequency	16KHz
System Luminous flux	80Lm/w
CRI	>90/97
Finish color	Sand white / sand black

Product performance

Saturation red reduction degree	R9=90
Color Accuracy	Rf≥92
Color Saturation	Rg=99
Color tolerance	SDCM<3
Light Fixture Material	Aluminium
Installation	Track

Light distribution parameters

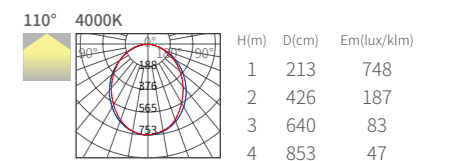
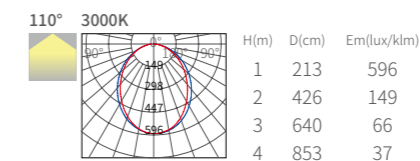

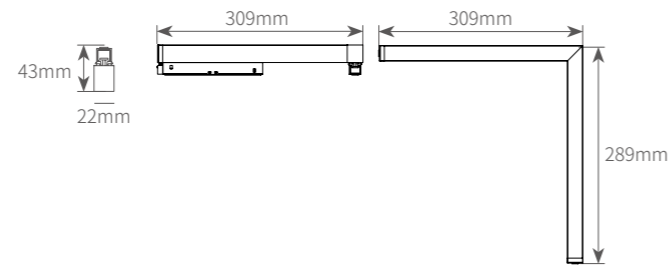
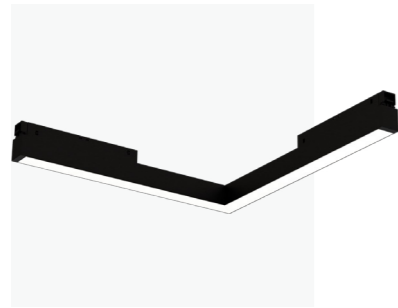

LMLL3015

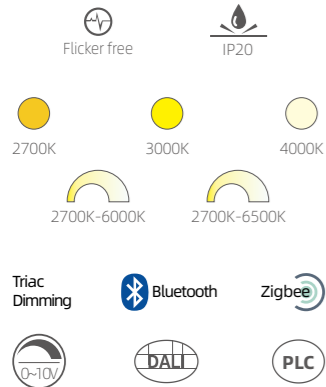

Product information

Power	15W
Beam angle	110°
Input voltage	24/48V
Input frequency	16KHz
System Luminous flux	80Lm/w
CRI	>90/97
Finish color	Sand white / sand black

Product performance

Saturation red reduction degree	R9=90
Color Accuracy	Rf≥92
Color Saturation	Rg=99
Color tolerance	SDCM<3
Light Fixture Material	Aluminium
Installation	Track

Light distribution parameters

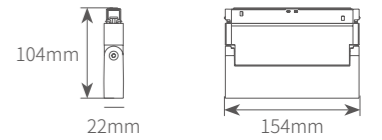
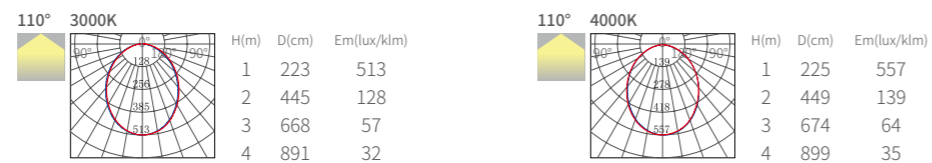

SMGL1505

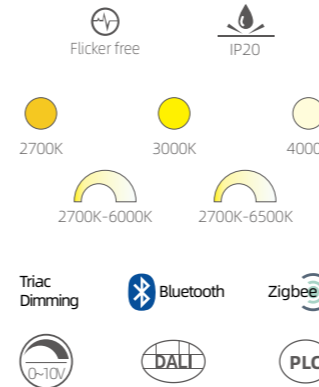

Product information

Power	5W
Beam angle	110°
Input voltage	24/48V
Input frequency	16KHz
System Luminous flux	80Lm/w
CRI	>90/97
Finish color	Sand white / sand black

Product performance

Saturation red reduction degree	R9=90
Color Accuracy	Rf≥92
Color Saturation	Rg=99
Color tolerance	SDCM<3
Light Fixture Material	Aluminium
Installation	Track

Light distribution parameters



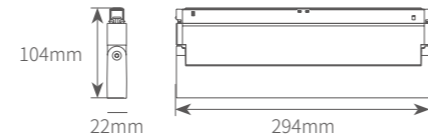
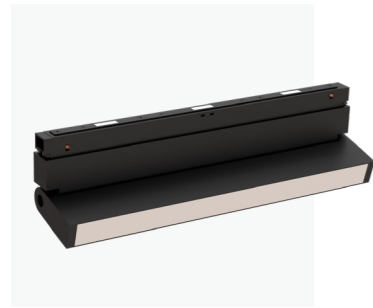

SMGL3007

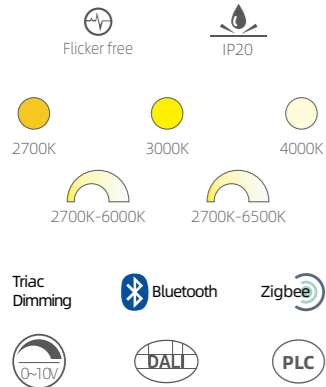

Product information

Power	7W
Beam angle	110°
Input voltage	24/48V
Input frequency	16KHz
System Luminous flux	80Lm/w
CRI	>90/97
Finish color	Sand white / sand black

Product performance

Saturation red reduction degree	R9=90
Color Accuracy	Rf≥92
Color Saturation	Rg=99
Color tolerance	SDCM<3
Light Fixture Material	Aluminium
Installation	Track

Light distribution parameters

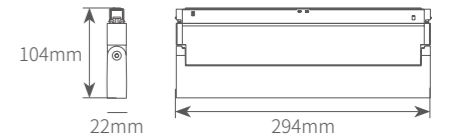
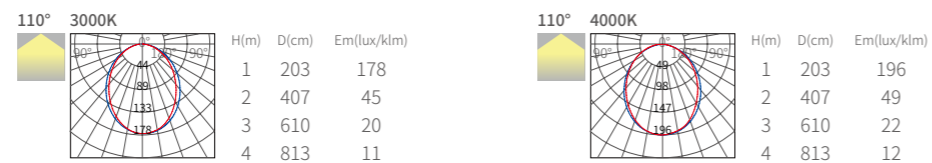

SMGL3010

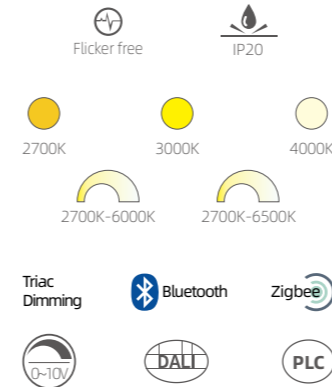

Product information

Power	10W
Beam angle	110°
Input voltage	24/48V
Input frequency	16KHz
System Luminous flux	80Lm/w
CRI	>90/97
Finish color	Sand white / sand black

Product performance

Saturation red reduction degree	R9=90
Color Accuracy	Rf≥92
Color Saturation	Rg=99
Color tolerance	SDCM<3
Light Fixture Material	Aluminium
Installation	Track

Light distribution parameters



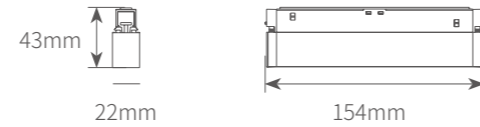

SMLS0606/SMLS0612

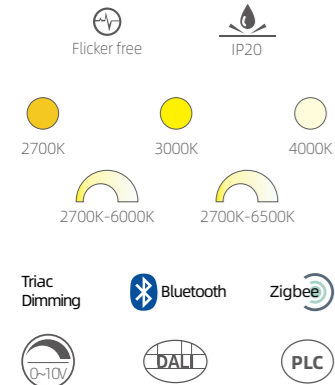

Product information

Power	6W/12W
Beam angle	Single CCT: 15°/30°/45° Tunable white: 24°/36°
Input voltage	24/48V
Input frequency	16KHz
System Luminous flux	80Lm/w
CRI	>90/97
Finish color	Sand white / sand black

Product performance

Saturation red reduction degree	R9=90
Color Accuracy	Rf≥92
Color Saturation	Rg=99
Color tolerance	SDCM<3
Light Fixture Material	Aluminium
Installation	Track

Light distribution parameters

Beam angle	Color Temp	Power	H(m)	D(cm)	Em(lux/klm)
15°	3000K	6W	1	34	2656
			2	68	664
			3	101	295
			4	135	166
15°	4000K	10W	1	34	3098
			2	38	732
			3	101	336
			4	135	216
30°	3000K	6W	1	52	1952
			2	104	488
			3	156	217
			4	208	122
30°	4000K	10W	1	56	2195
			2	111	549
			3	167	244
			4	223	137
45°	3000K	6W	1	75	1272
			2	150	318
			3	225	141
			4	300	80
45°	4000K	10W	1	86	1180
			2	172	295
			3	259	131
			4	345	74

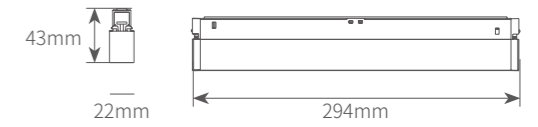

SMLS1212/SMLS1224

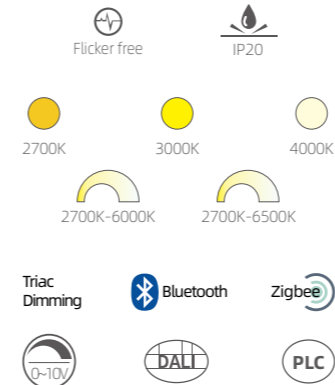

Product information

Power	12W/20W
Beam angle	Single CCT: 15°/30°/45° Tunable white: 24°/36°
Input voltage	24/48V
Input frequency	16KHz
System Luminous flux	80Lm/w
CRI	>90/97
Finish color	Sand white / sand black

Product performance

Saturation red reduction degree	R9=90
Color Accuracy	Rf≥92
Color Saturation	Rg=99
Color tolerance	SDCM<3
Light Fixture Material	Aluminium
Installation	Track

Light distribution parameters

Beam angle	Color Temp	Power	H(m)	D(cm)	Em(lux/klm)
15°	3000K	12W	1	37	4492
			2	74	1123
			3	112	499
			4	149	280
15°	4000K	20W	1	32	7906
			2	64	1976
			3	95	878
			4	127	494
30°	3000K	12W	1	53	3659
			2	105	915
			3	158	407
			4	210	229
30°	4000K	20W	1	43	6830
			2	86	1707
			3	129	759
			4	171	427
45°	3000K	12W	1	74	2545
			2	147	636
			3	221	283
			4	295	159
45°	4000K	20W	1	74	2497
			2	147	874
			3	221	389
			4	294	219

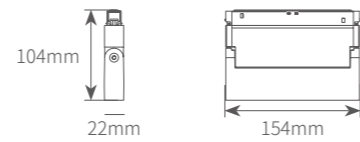

SMGS0606/SMGS0612

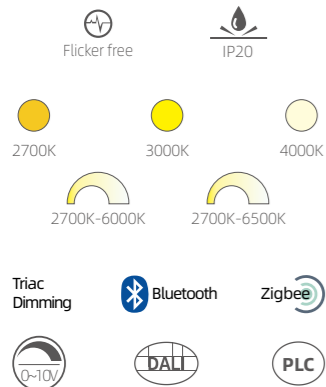

Product information

Power	6W/12W
Beam angle	Single CCT: 15°/30°/45° Tunable white: 24°/36°
Input voltage	24/48V
Input frequency	16KHz
System Luminous flux	80Lm/w
CRI	>90/97
Finish color	Sand white / sand black

Product performance

Saturation red reduction degree	R9=90
Color Accuracy	Rf≥92
Color Saturation	Rg=99
Color tolerance	SDCM<3
Light Fixture Material	Aluminium
Installation	Track

Light distribution parameters

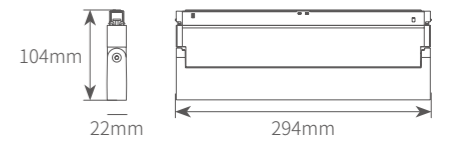
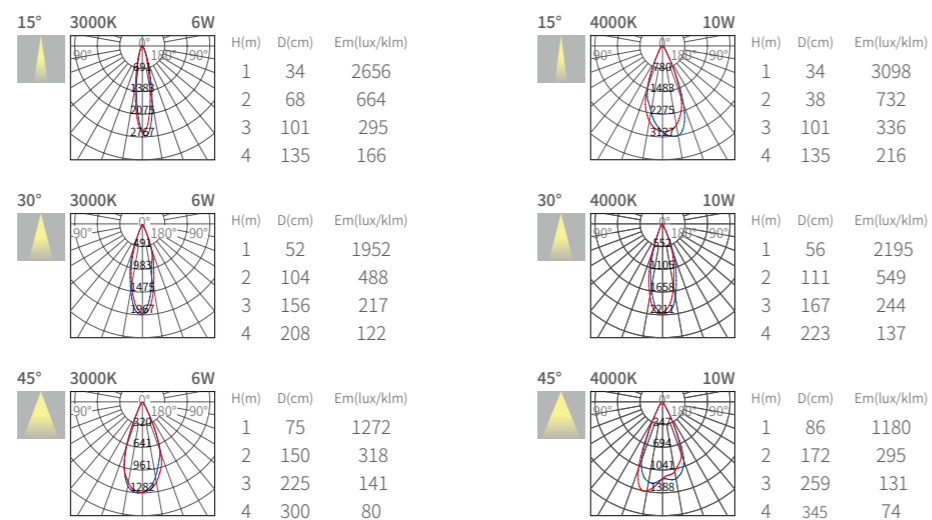

SMGS1212/SMGS1224

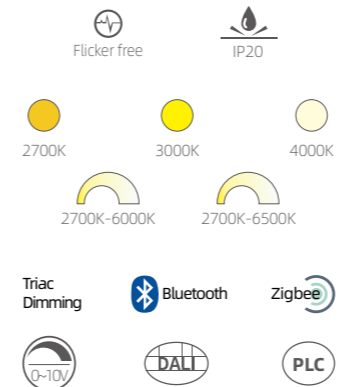

Product information

Power	12/24W
Beam angle	Single CCT: 15°/30°/45° Tunable white: 24°/36°
Input voltage	24/48V
Input frequency	16KHz
System Luminous flux	80Lm/w
CRI	>90/97
Finish color	Sand white / sand black

Product performance

Saturation red reduction degree	R9=90
Color Accuracy	Rf≥92
Color Saturation	Rg=99
Color tolerance	SDCM<3
Light Fixture Material	Aluminium
Installation	Track

Light distribution parameters

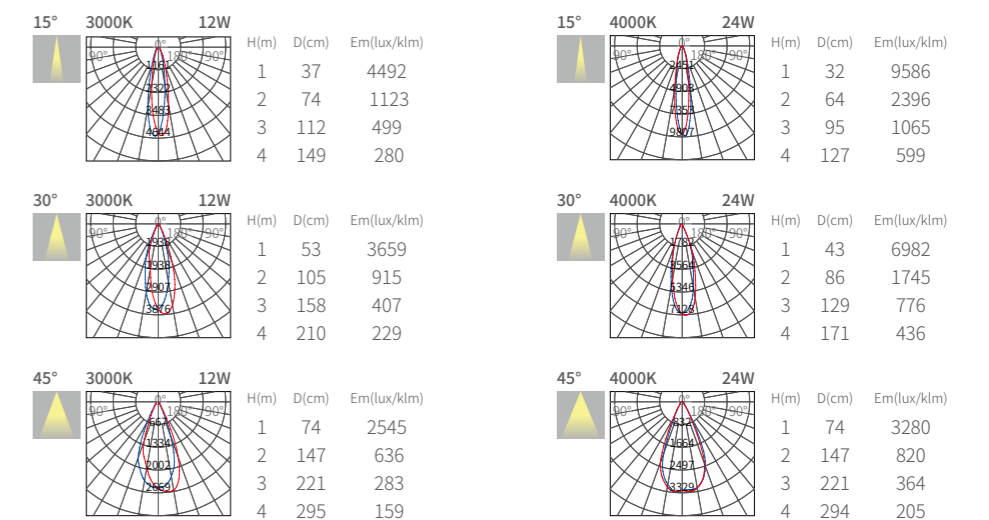

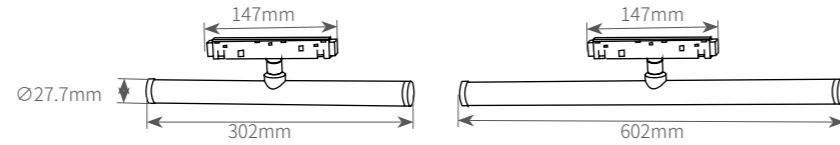
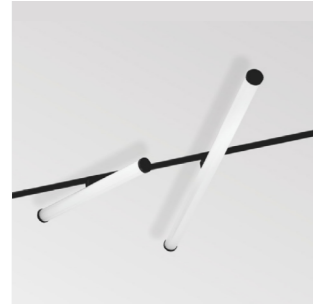

SMLT3006/SMLT6012

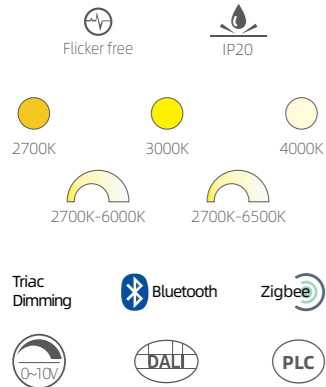

Product information	
Power	6W/12W
Beam angle	120°
Input voltage	48V
Input frequency	16KHz
System Luminous flux	80Lm/w
CRI	>90
Finish color	Sand white / sand black

Product performance	
Saturation red reduction degree	R9=90
Color Accuracy	Rf≥92
Color Saturation	Rg=99
Color tolerance	SDCM<3
Light Fixture Material	Aluminium
Installation	Track

Light distribution parameters

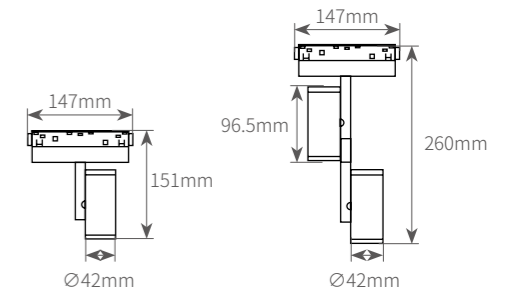
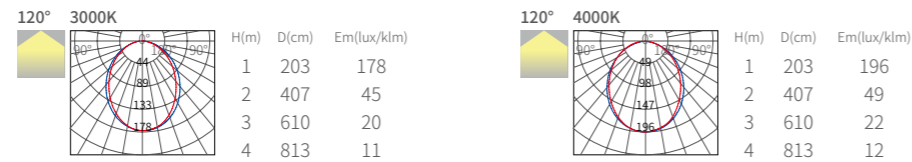

SMS4208/SMS4216

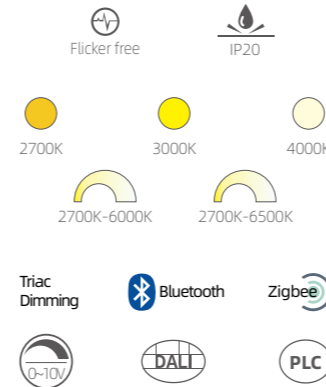

Product information	
Power	8W/16W
Beam angle	15°/24°/36°
Input voltage	48V
Input frequency	16KHz
System Luminous flux	80Lm/w
CRI	>90
Finish color	Sand white / sand black

Product performance	
Saturation red reduction degree	R9=90
Color Accuracy	Rf≥92
Color Saturation	Rg=99
Color tolerance	SDCM<3
Light Fixture Material	Aluminium
Installation	Track

Light distribution parameters

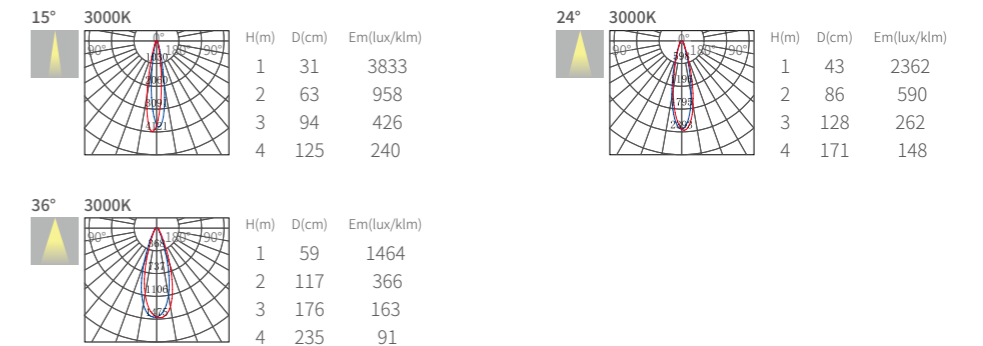

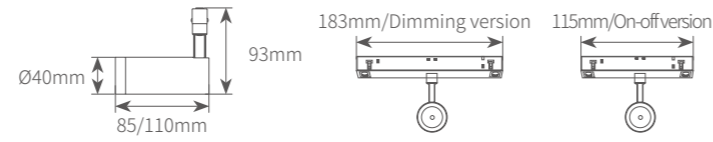

SMS4005/SMS4008

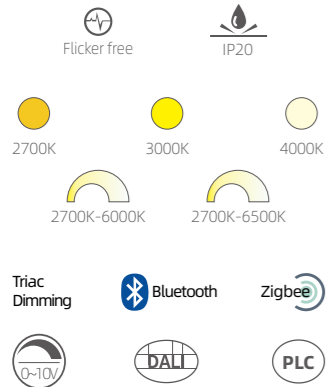

Product information

Power	5W/8W
Beam angle	15°/24°/36°
Input voltage	24/48V
Input frequency	16KHz
System Luminous flux	75Lm/w
CRI	>90/97
Finish color	Sand white / sand black

Product performance

Saturation red reduction degree	R9=90
Color Accuracy	Rf≥92
Color Saturation	Rg=99
Color tolerance	SDCM<3
Light Fixture Material	Aluminium
Installation	Track

Light distribution parameters

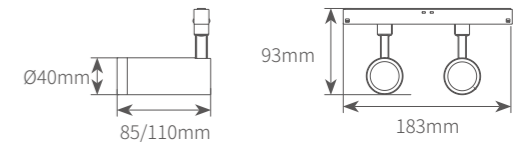
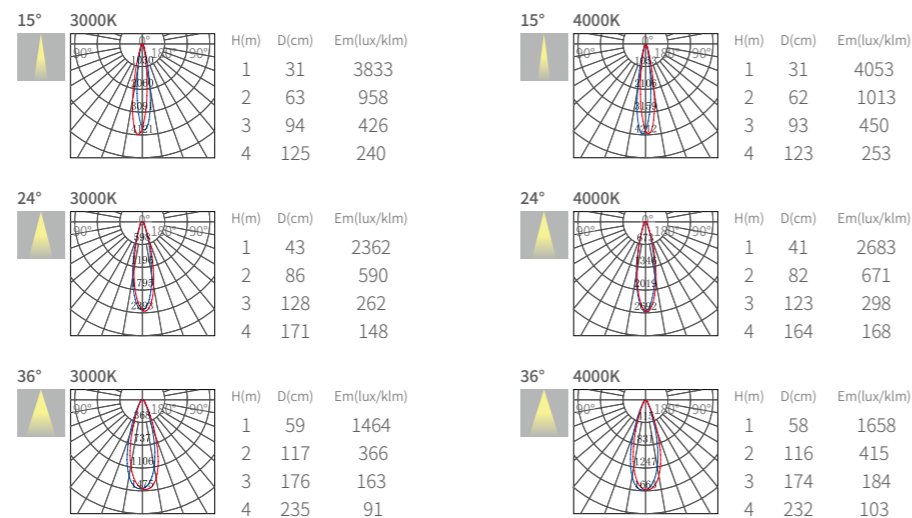

SMS4010/SMS4016

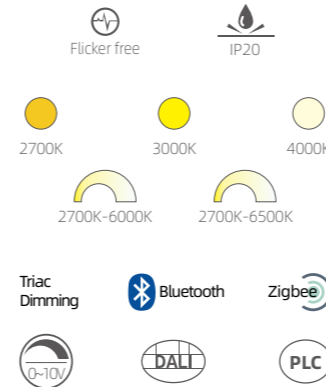

Product information

Power	10W/16W
Beam angle	15°/24°/36°
Input voltage	24/48V
Input frequency	16KHz
System Luminous flux	75Lm/w
CRI	>90/97
Finish color	Sand white / sand black

Product performance

Saturation red reduction degree	R9=90
Color Accuracy	Rf≥92
Color Saturation	Rg=99
Color tolerance	SDCM<3
Light Fixture Material	Aluminium
Installation	Track

Light distribution parameters

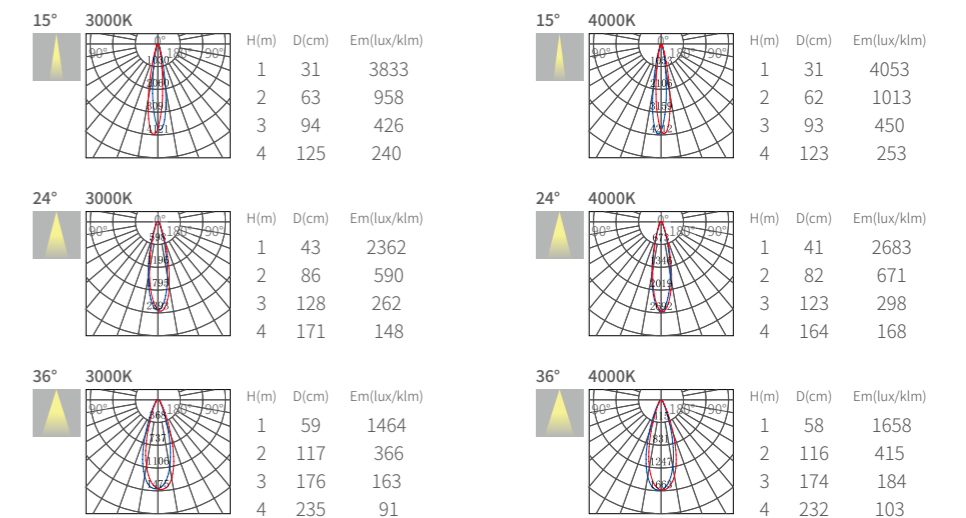

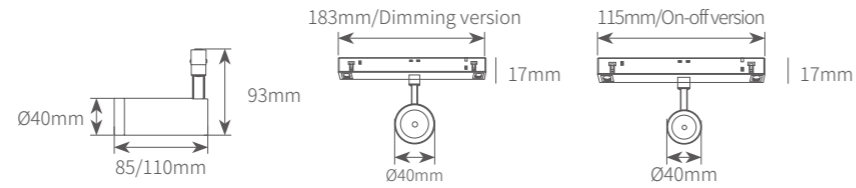

SMS4005F/SMS4008F

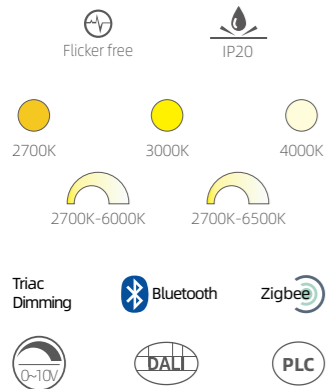

Product information

Power	5W/8W
Beam angle	15°-36° zoomable
Input voltage	24/48V
Input frequency	16KHz
System Luminous flux	75Lm/w
CRI	>90/97
Finish color	Sand white / sand black

Product performance

Saturation red reduction degree	R9=90
Color Accuracy	Rf≥92
Color Saturation	Rg=99
Color tolerance	SDCM<3
Light Fixture Material	Aluminium
Installation	Track

Light distribution parameters

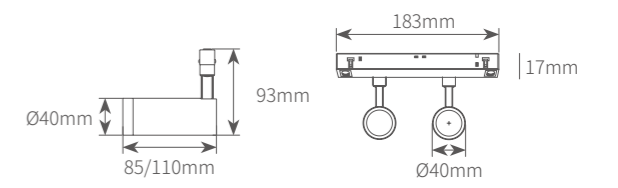
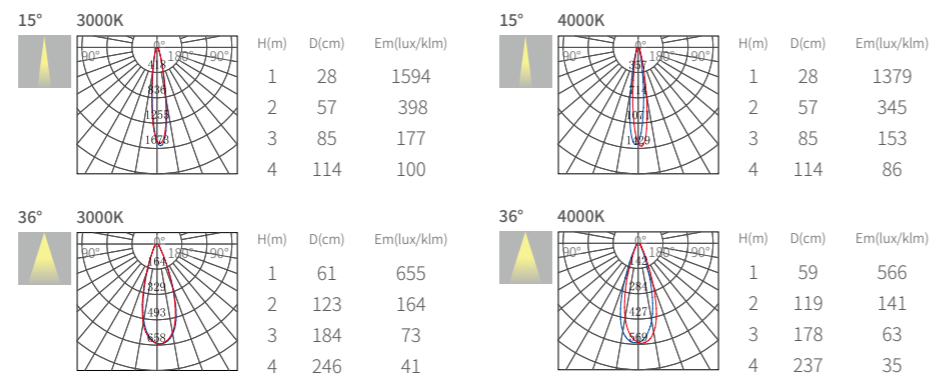

SMS4010F/SMS4016F

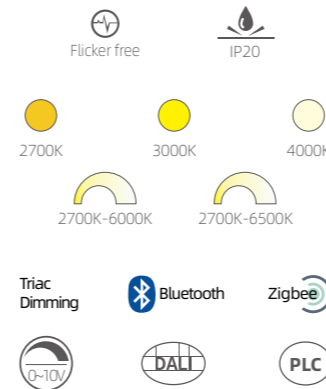

Product information

Power	10W/16W
Beam angle	15°-36° zoomable
Input voltage	24/48V
Input frequency	16KHz
System Luminous flux	75Lm/w
CRI	>90/97
Finish color	Sand white / sand black

Product performance

Saturation red reduction degree	R9=90
Color Accuracy	Rf≥92
Color Saturation	Rg=99
Color tolerance	SDCM<3
Light Fixture Material	Aluminium
Installation	Track

Light distribution parameters

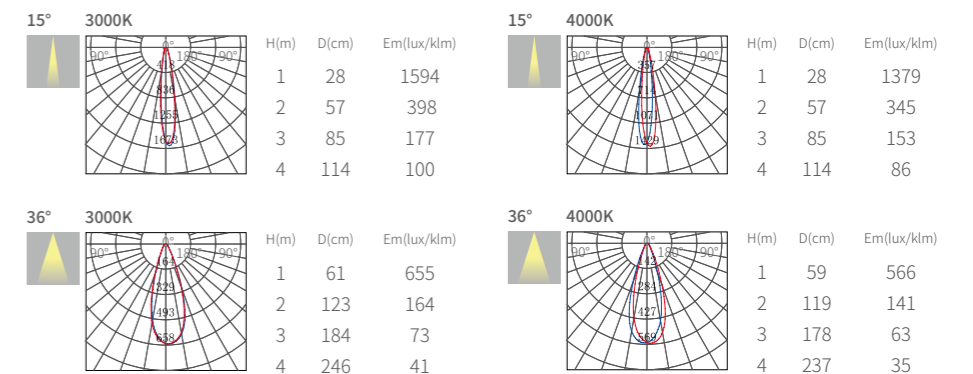

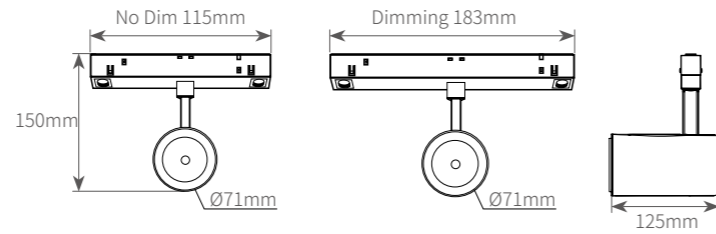

SMS5415

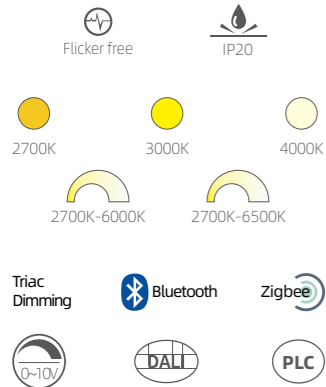

Product information

Power	15W
Beam angle	15°/24°/36°
Input voltage	24/48V
Input frequency	16KHz
System Luminous flux	87Lm/w
CRI	Ra 90
Finish color	Sand white / sand black

Product performance

Saturation red reduction degree	R9=90
Color Accuracy	Rf≥92
Color Saturation	Rg=99
Color tolerance	SDCM<3
Light Fixture Material	Aluminium
Installation	Track

Light distribution parameters

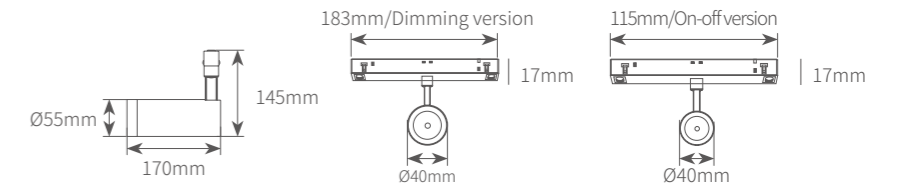
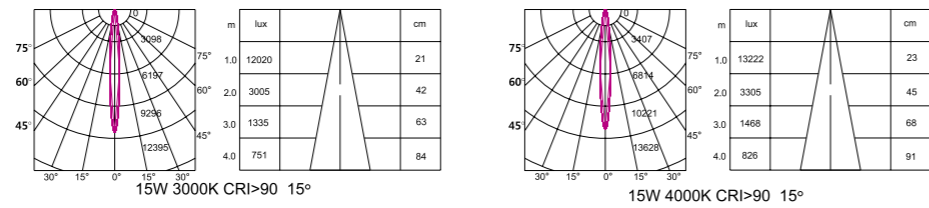

SMS5515

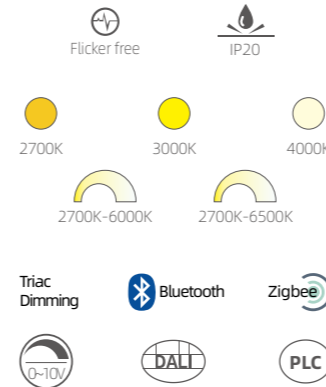

Product information

Power	15W
Beam angle	15°/24°/36°
Input voltage	24/48V
Input frequency	16KHz
System Luminous flux	82Lm/w
CRI	Ra 90
Finish color	Sand white / sand black

Product performance

Saturation red reduction degree	R9=90
Color Accuracy	Rf≥92
Color Saturation	Rg=99
Color tolerance	SDCM<3
Light Fixture Material	Aluminium
Installation	Track

Light distribution parameters

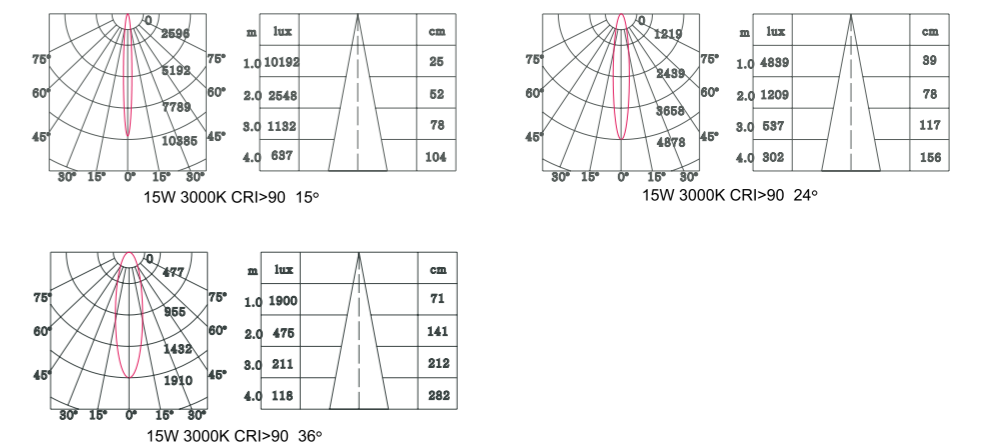

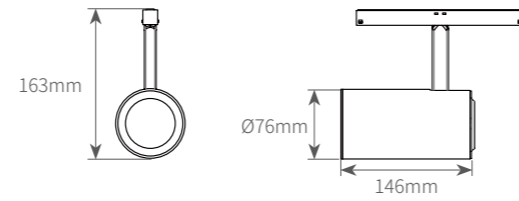

SMS7615/SMS7620/SMS7625/SMS7630

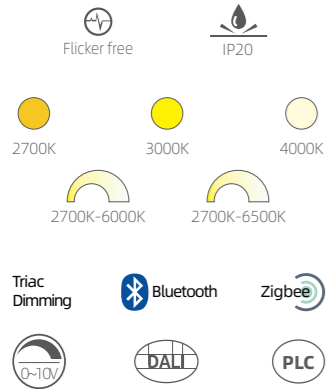

Product information

Power	15W/20W/25W/30W
Beam angle	15°/24°/36°
Input voltage	24/48V
Input frequency	16KHz
System Luminous flux	82Lm/w
CRI	Ra 90
Finish color	Sand white / sand black

Product performance

Saturation red reduction degree	R9=90
Color Accuracy	Rf≥92
Color Saturation	Rg=99
Color tolerance	SDCM<3
Light Fixture Material	Aluminium
Installation	Track

Light distribution parameters

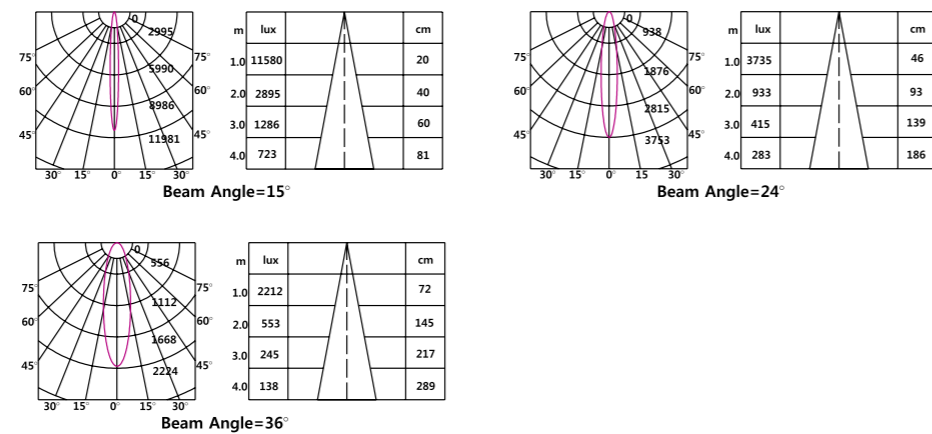

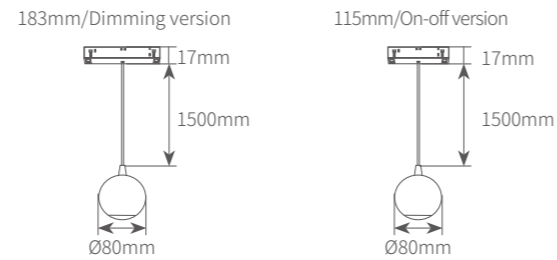
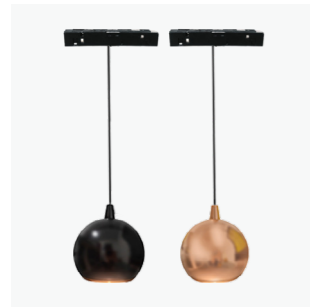

SMP8005

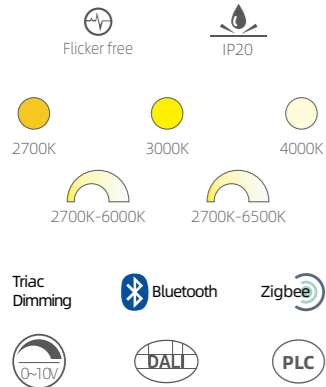

Product information

Power	5W
Beam angle	75°
Input voltage	24/48V
Input frequency	16KHz
System Luminous flux	60Lm/w
CRI	>90/97
Finish color	rose gold / Pearl black

Product performance

Saturation red reduction degree	R9=90
Color Accuracy	Rf≥92
Color Saturation	Rg=99
Color tolerance	SDCM<3
Light Fixture Material	Aluminium
Installation	Track

Light distribution parameters

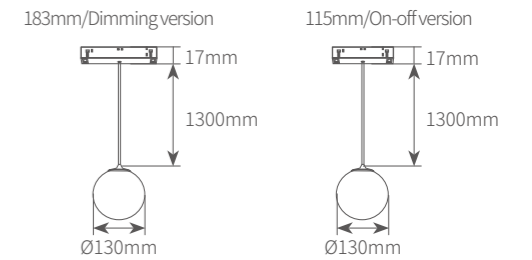
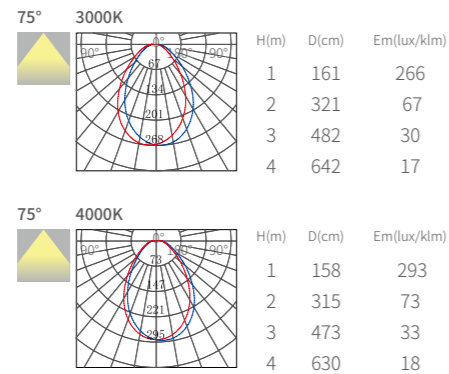

SMP13006

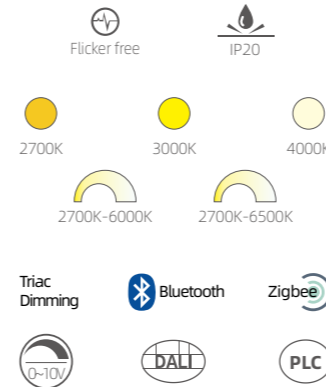

Product information

Power	6W
Beam angle	220°
Input voltage	24/48V
Input frequency	16KHz
System Luminous flux	60Lm/w
CRI	>90/97
Finish color	Marble white

Product performance

Saturation red reduction degree	R9=90
Color Accuracy	Rf≥92
Color Saturation	Rg=99
Color tolerance	SDCM<3
Light Fixture Material	Aluminium
Installation	Track

Light distribution parameters

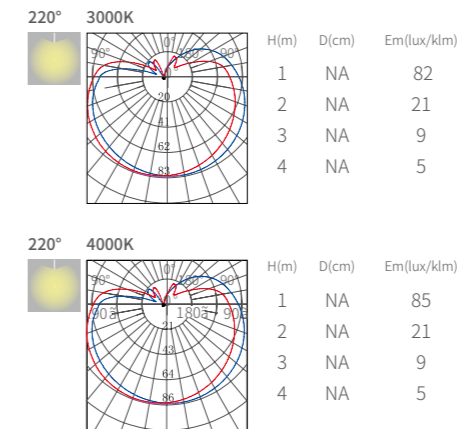

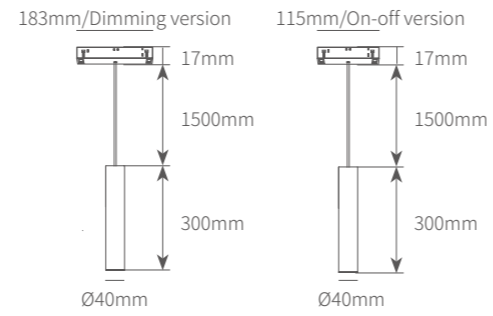

SMP4008/SMP4015

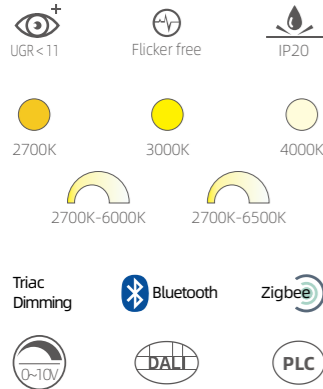

Product information

Power	8W/15W
Beam angle	15°/30°/36°
Input voltage	24/48V
Input frequency	16KHz
System Luminous flux	70Lm/w
CRI	>90/97
Finish color	Sand white / sand black

Product performance

Saturation red reduction degree	R9=90
Color Accuracy	Rf≥92
Color Saturation	Rg=99
Color tolerance	SDCM<3
Light Fixture Material	Aluminium
Installation	Track

Light distribution parameters

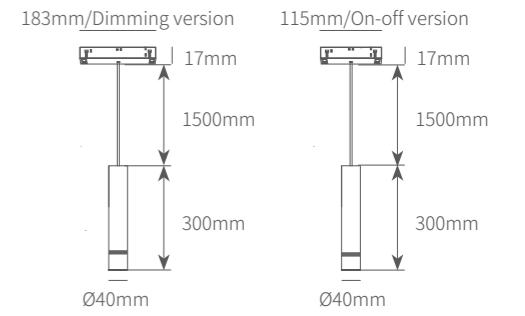
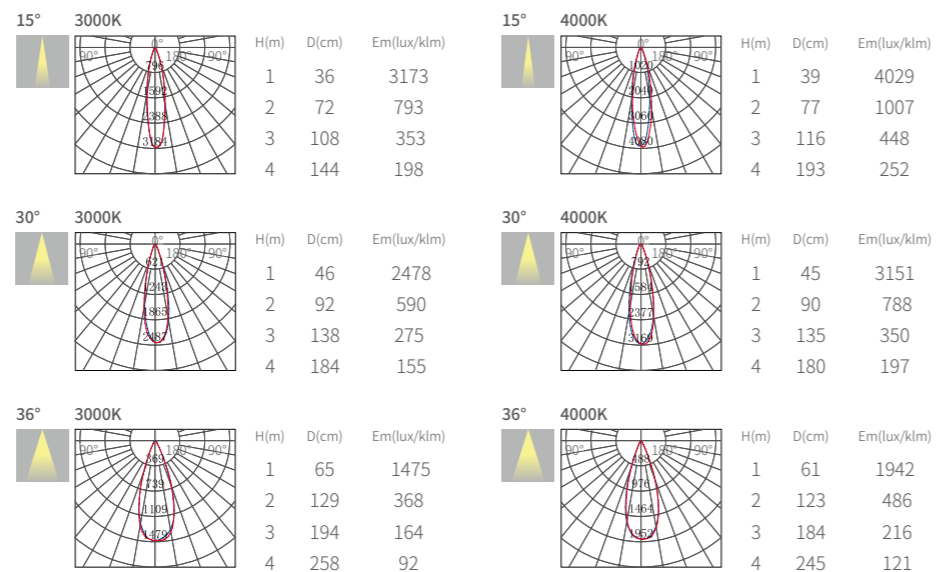

SMP4008F/SMP4015F

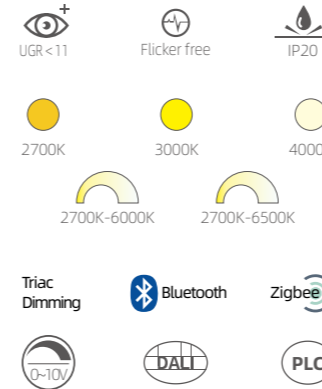

Product information

Power	8W/15W
Beam angle	15°-36° zoomable
Input voltage	24/48V
Input frequency	16KHz
System Luminous flux	70Lm/w
CRI	>90/97
Finish color	Sand white / sand black

Product performance

Saturation red reduction degree	R9=90
Color Accuracy	Rf≥92
Color Saturation	Rg=99
Color tolerance	SDCM<3
Light Fixture Material	Aluminium
Installation	Track

Light distribution parameters

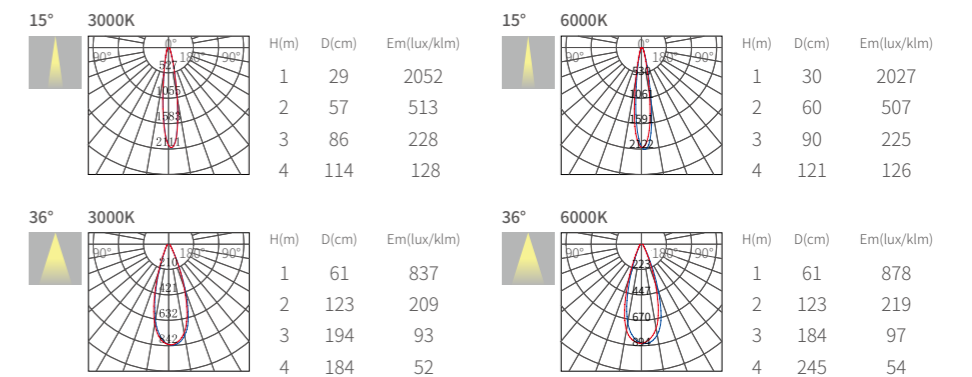

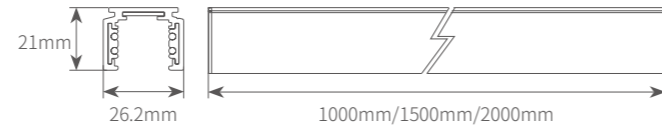

MSSM-M

Product information

Power	384W Max
Beam angle	/
Input voltage	DC24V
Input frequency	/
System Luminous flux	/
CRI	/
Finish color	Black

Product performance

Saturation red reduction degree	/
Color Accuracy	/
Color Saturation	/
Color tolerance	/
Light Fixture Material	Aluminum + Copper
Installation	Surface Mounted

Accessories

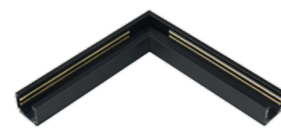

Model D7

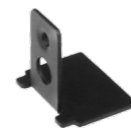

Model D15



Model D17

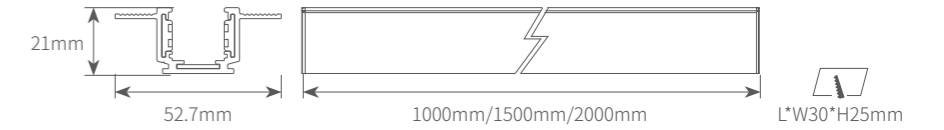

MSRC-A

Product information

Power	384W Max
Beam angle	/
Input voltage	DC24V
Input frequency	/
System Luminous flux	/
CRI	/
Finish color	Black

Product performance

Saturation red reduction degree	/
Color Accuracy	/
Color Saturation	/
Color tolerance	/
Light Fixture Material	Aluminum + Copper
Installation	Recessed

Accessories

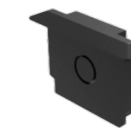

Model D46

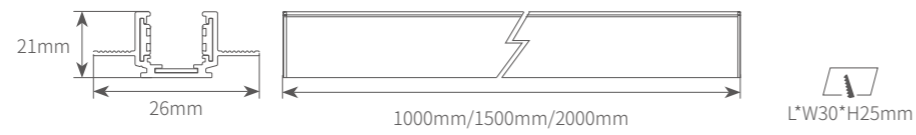

MSRC-B

Product information

Power	384W Max
Beam angle	/
Input voltage	DC24V
Input frequency	/
System Luminous flux	/
CRI	/
Finish color	Black

Product performance

Saturation red reduction degree	/
Color Accuracy	/
Color Saturation	/
Color tolerance	/
Light Fixture Material	Aluminum + Copper
Installation	Recessed

Accessories

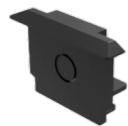

Model D46

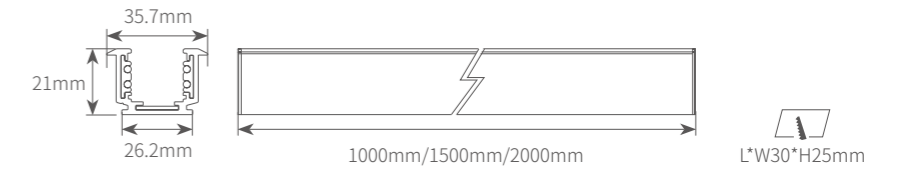

MSRC-C

Product information

Power	384W Max
Beam angle	/
Input voltage	DC24V
Input frequency	/
System Luminous flux	/
CRI	/
Finish color	Black

Product performance

Saturation red reduction degree	/
Color Accuracy	/
Color Saturation	/
Color tolerance	/
Light Fixture Material	Aluminum + Copper
Installation	Recessed

Accessories

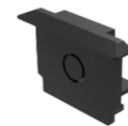

Model D46

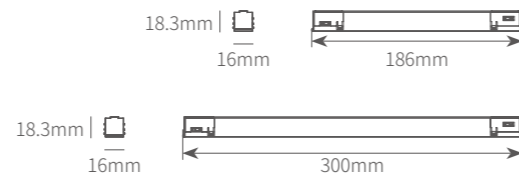

MSMLS0606/MSMLS1212

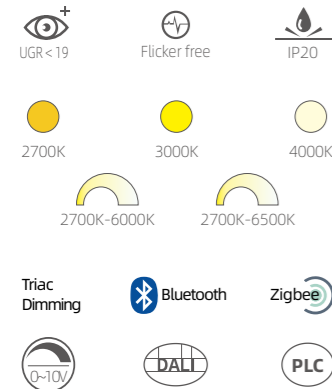

Product information

Power	6W/12W
Beam angle	24°/36°
Input voltage	24V
Input frequency	16KHz
System Luminous flux	60Lm/w
CRI	>90/97
Finish color	Sand white / sand black

Product performance

Saturation red reduction degree	R9=90
Color Accuracy	Rf≥92
Color Saturation	Rg=99
Color tolerance	SDCM<3
Light Fixture Material	Aluminium
Installation	Track

Light distribution parameters

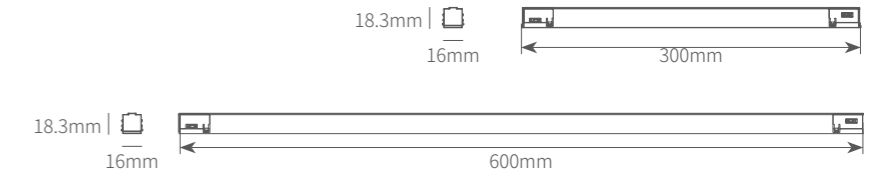
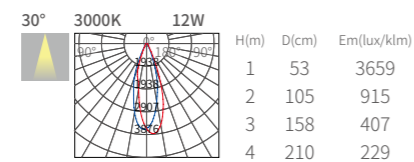
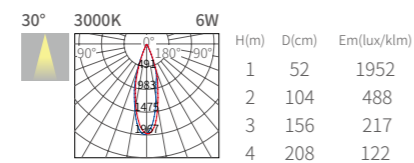

MSMLL3006/MSMLL6012

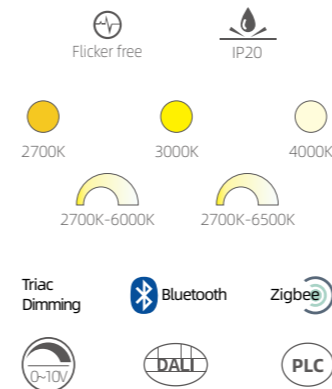

Product information

Power	6W/12W
Beam angle	110°
Input voltage	24V
Input frequency	16KHz
System Luminous flux	60Lm/w
CRI	>90/97
Finish color	Sand white / sand black

Product performance

Saturation red reduction degree	R9=90
Color Accuracy	Rf≥92
Color Saturation	Rg=99
Color tolerance	SDCM<3
Light Fixture Material	Aluminium
Installation	Track

Light distribution parameters

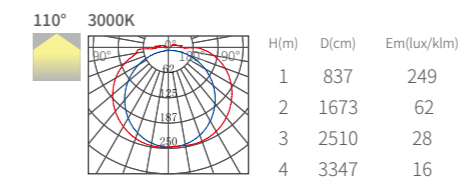

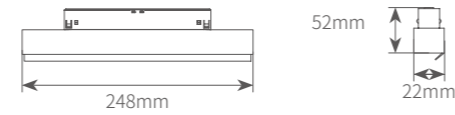

MSMW2515

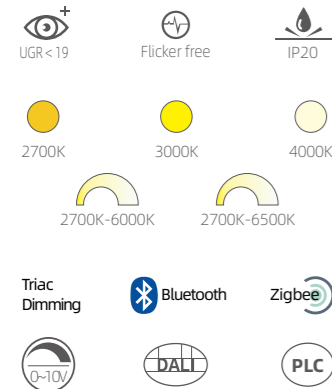

Product information

Power	15W
Beam angle	35° * 70°
Input voltage	24V
Input frequency	16KHz
System Luminous flux	65Lm/w
CRI	>90/97
Finish color	Sand white / sand black

Product performance

Saturation red reduction degree	R9=90
Color Accuracy	Rf≥92
Color Saturation	Rg=99
Color tolerance	SDCM<3
Light Fixture Material	Aluminium
Installation	Track

Light distribution parameters

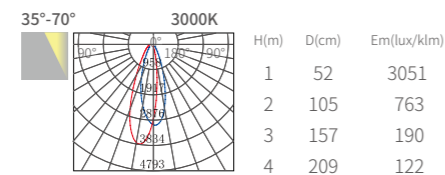

CURVE MAGNETIC SYSTEM V6.0

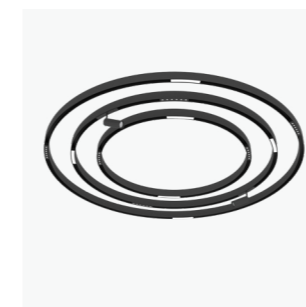

CL-600 ~ CL-3000

Product information

Input voltage	24/48V
Finish color	Black
Circle Dimater	Φ600/Φ800/Φ900/Φ1000/Φ1200/Φ1500/Φ1800/Φ2000/Φ2400/Φ3000mm
Dimension	D600/D800/D900/D1000/D1200/D1500/D1800/D2000/D2400/D3000*W52*H52mm

Product performance

Saturation red reduction degree	/
Color Accuracy	/
Color Saturation	/
Color tolerance	/
Light Fixture Material	Aluminium
Installation	Recessed / Surface mount / Pendant

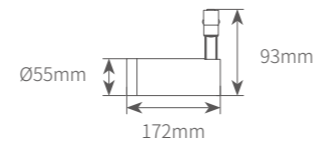

CL-SM5508/CL-SM5510/CL-SM5515

Product information	
Power	8W/10W/15W
Beam angle	15°/24°/36°
Input voltage	DC24V
Input frequency	16KHz
System Luminous flux	80Lm/w
CRI	>90
Finish color	Sand white / Sand black

Product performance	
Saturation red reduction degree	R9=90
Color Accuracy	Rf≥92
Color Saturation	Rg=99
Color tolerance	SDCM<3
Light Fixture Material	Aluminium
Installation	Track

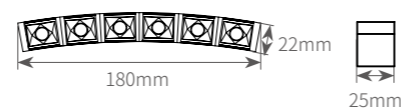
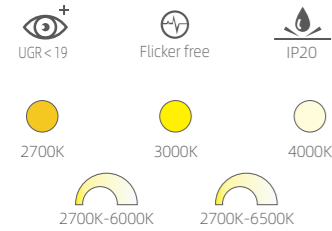

CL-SLS0606

Product information	
Power	6W
Beam angle	15°/24°/36°
Input voltage	DC24V
Input frequency	16KHz
System Luminous flux	80Lm/w
CRI	>90
Finish color	Sand white / Sand black

Product performance	
Saturation red reduction degree	R9=90
Color Accuracy	Rf≥92
Color Saturation	Rg=99
Color tolerance	SDCM<3
Light Fixture Material	Aluminium
Installation	Track

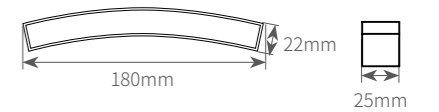
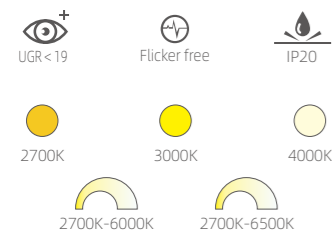

CL-SLL2007

Product information	
Power	7W
Beam angle	110°
Input voltage	DC24V
Input frequency	16KHz
System Luminous flux	80Lm/w
CRI	>90
Finish color	Sand white / Sand black

Product performance	
Saturation red reduction degree	R9=90
Color Accuracy	Rf≥92
Color Saturation	Rg=99
Color tolerance	SDCM<3
Light Fixture Material	Aluminium
Installation	Track

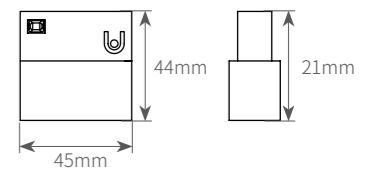
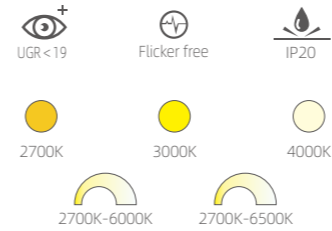

CL-SLS0202

Product information	
Power	2W
Beam angle	15°/24°/36°
Input voltage	DC24V
Input frequency	16KHz
System Luminous flux	80Lm/w
CRI	>90
Finish color	Sand white / Sand black

Product performance	
Saturation red reduction degree	R9=90
Color Accuracy	Rf≥92
Color Saturation	Rg=99
Color tolerance	SDCM<3
Light Fixture Material	Aluminium
Installation	Track

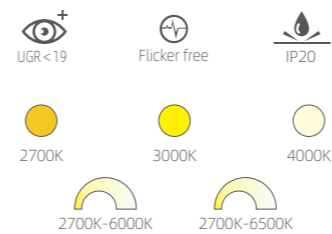

ARMANI RECESSED
LINEAR SERIES

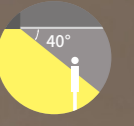

UGR<11



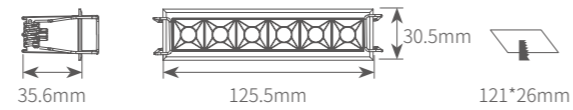

LMN0608

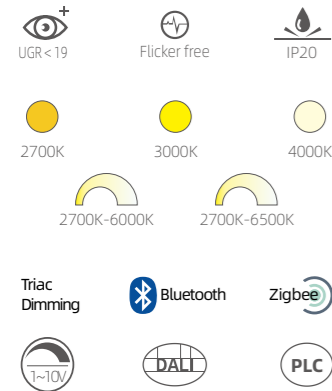

Product information

Power	8W
Beam angle	25°/36°
Input voltage	AC 200-240V
Input frequency	50Hz
System Luminous flux	70Lm/w
CRI	Ra > 90
Finish color	White+Titanium

Product performance

Saturation red reduction degree	R9=90
Color Accuracy	Rf ≥ 92
Color Saturation	Rg=99
Color tolerance	SDCM < 3
Light Fixture Material	Aluminium
Installation	Recessed

Schematic diagram below

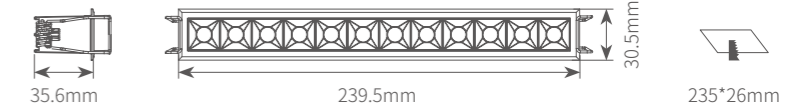
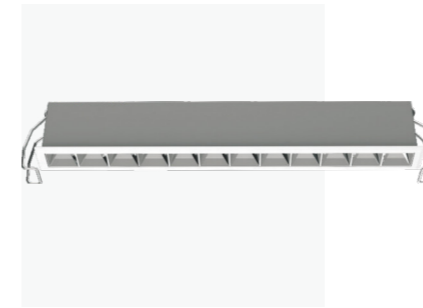
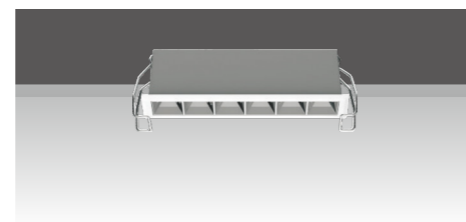
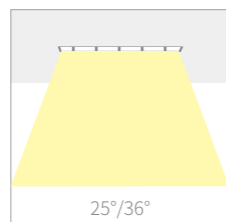

LMN1212

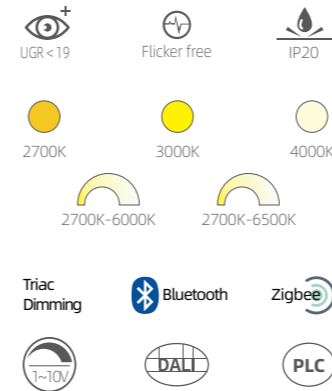

Product information

Power	12W
Beam angle	25°/36°
Input voltage	AC 200-240V
Input frequency	50Hz
System Luminous flux	70Lm/w
CRI	Ra > 90
Finish color	White+Titanium

Product performance

Saturation red reduction degree	R9=90
Color Accuracy	Rf ≥ 92
Color Saturation	Rg=99
Color tolerance	SDCM < 3
Light Fixture Material	Aluminium
Installation	Recessed

Schematic diagram below

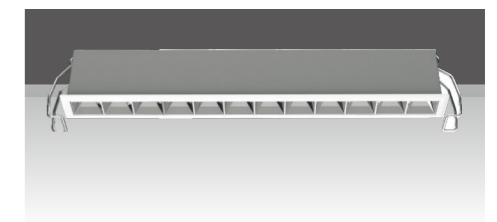
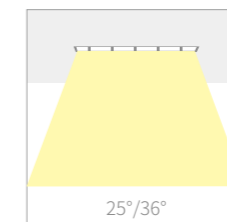

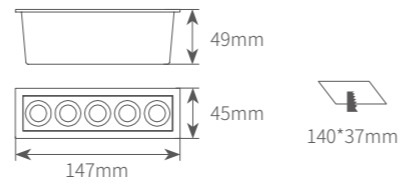

LMN0510

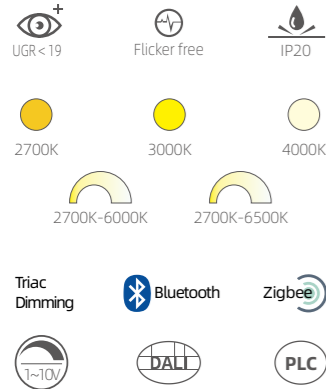

Product information

Power	10W
Beam angle	15°/30°/45°
Input voltage	AC 200-240V
Input frequency	50Hz
System Luminous flux	80Lm/w
CRI	Ra > 90
Finish color	White+Titanium

Product performance

Saturation red reduction degree	R9=90
Color Accuracy	Rf ≥ 92
Color Saturation	Rg=99
Color tolerance	SDCM < 3
Light Fixture Material	Aluminium
Installation	Recessed

Schematic diagram below

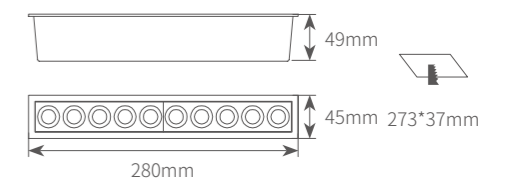
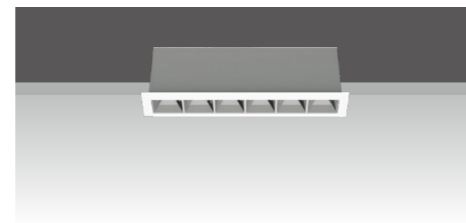
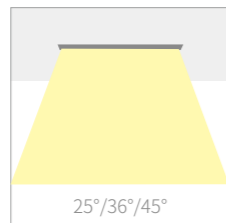

LMN1020

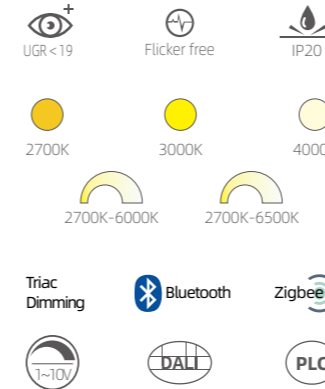

Product information

Power	20W
Beam angle	15°/30°/45°
Input voltage	AC 200-240V
Input frequency	50Hz
System Luminous flux	80Lm/w
CRI	Ra > 90
Finish color	White+Titanium

Product performance

Saturation red reduction degree	R9=90
Color Accuracy	Rf ≥ 92
Color Saturation	Rg=99
Color tolerance	SDCM < 3
Light Fixture Material	Aluminium
Installation	Recessed

Schematic diagram below

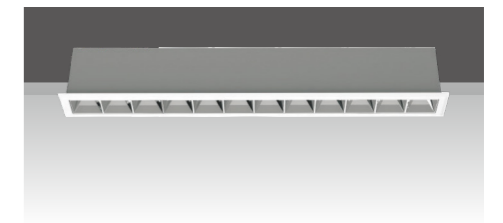
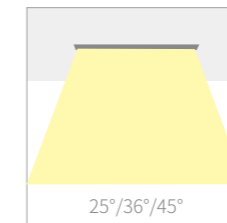

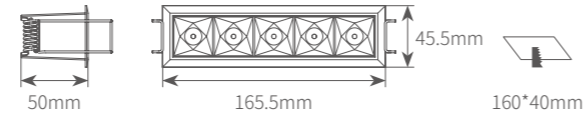

LMN0510-W/LMN0510-W-CW

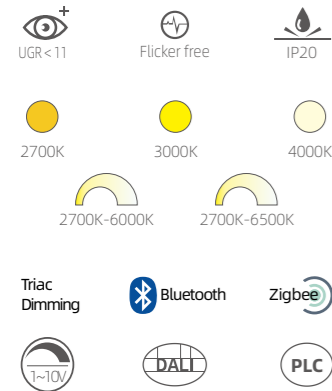

Product information	10W
Power	10W
Beam angle	35° * 70°
Input voltage	AC 200-240V
Input frequency	50Hz
System Luminous flux	75Lm/w
CRI	Ra > 90
Finish color	White+Titanium

Product performance	
Saturation red reduction degree	R9=90
Color Accuracy	Rf ≥ 92
Color Saturation	Rg=99
Color tolerance	SDCM < 3
Light Fixture Material	Aluminium
Installation	Recessed

Schematic diagram below

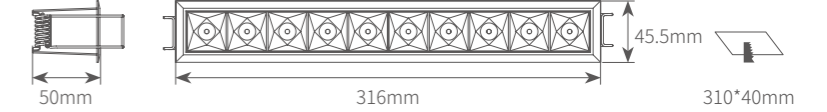
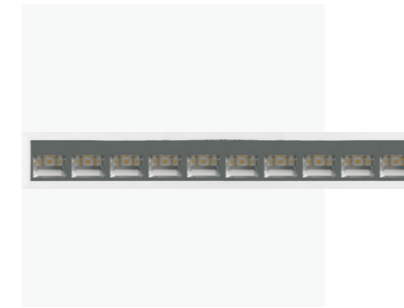
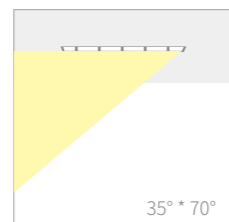

LMN1020-W/LMN1020-W-CW

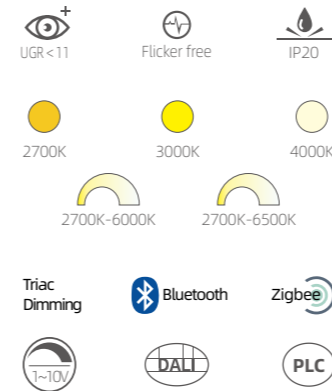

Product information	12W
Power	12W
Beam angle	35° * 70°
Input voltage	AC 200-240V
Input frequency	50Hz
System Luminous flux	75Lm/w
CRI	Ra > 90
Finish color	White+Titanium

Product performance	
Saturation red reduction degree	R9=90
Color Accuracy	Rf ≥ 92
Color Saturation	Rg=99
Color tolerance	SDCM < 3
Light Fixture Material	Aluminium
Installation	Recessed

Schematic diagram below

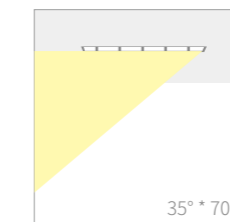

LED FLEXIBLE STRIP SERIES



LED STRIP STRUCTURE

The LED strip light is composed of FPC, LED Chip, SMD resistor, IC, waterproof silicone, connecting terminals and so on

I Light strip type

One LED one cut

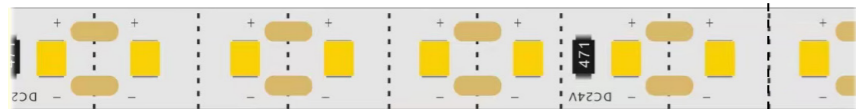

I LED

CRI > 80

CRI > 90

CRI > 95

2200K 2400K 2700K 3000K 3500K 4000K 5000K 5700K 6500K

I Double layer copper flexible circuit board

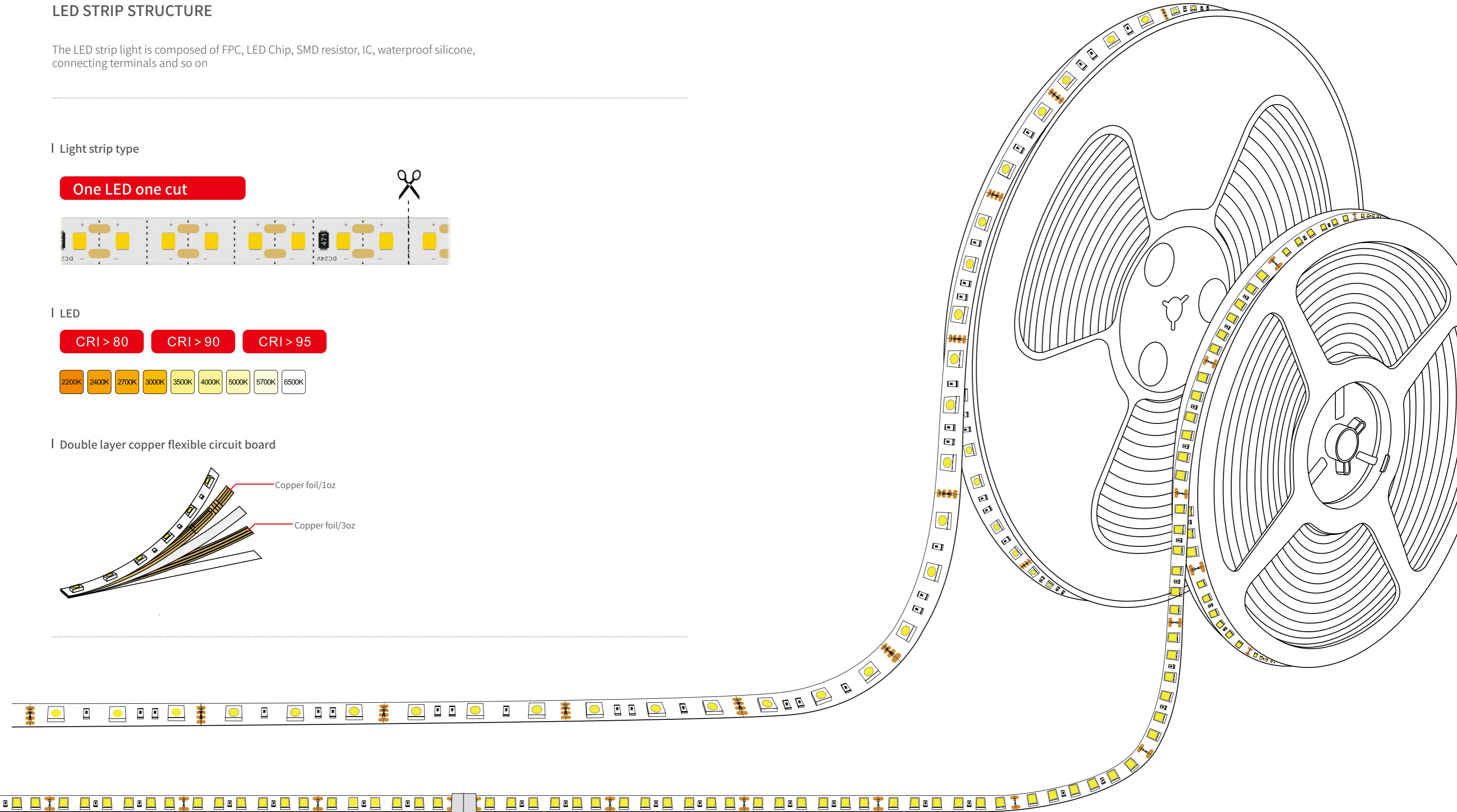
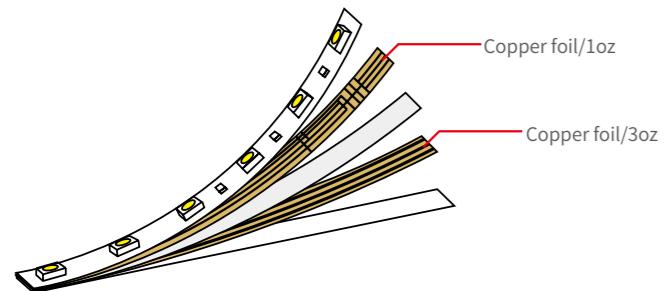

LB2835-24/08-10W-120D



Product information

Power	10W/m
LED QTY	120LED/m
Input voltage	DC24V
PCB width	8mm
System Luminous flux	95Lm/w
CRI	Ra>90/95
Cut length	One LED one cut

Product performance

Saturation red reduction degree	R9=90
Color Accuracy	Rf≥92
Color Saturation	Rg=99
Color tolerance	SDCM<3
Light Fixture Material	/
Installation	Paving or aluminum groove

LB2835-24/08-12W-120S



Product information

Power	12W/m
LED QTY	120LED/m
Input voltage	DC24V
PCB width	8mm
System Luminous flux	75Lm/w
CRI	Ra>90/95
Cut length	One LED one cut

Product performance

Saturation red reduction degree	R9=90
Color Accuracy	Rf≥92
Color Saturation	Rg=99
Color tolerance	SDCM<3
Light Fixture Material	/
Installation	Paving or aluminum groove



FS2835-24/08-10W-120D

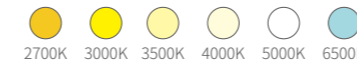

Product information

Power	10W/m
LED QTY	120LED/m
Input voltage	DC24V
PCB width	8mm
System Luminous flux	95Lm/w
CRI	Ra>90/95
Cut length	One LED one cut

Product performance

Saturation red reduction degree	R9=90
Color Accuracy	Rf≥92
Color Saturation	Rg=99
Color tolerance	SDCM<3
Light Fixture Material	/
Installation	Paving or aluminum groove

FS2835-24/08-12W-120S

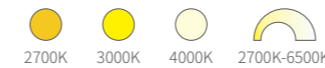

Product information

Power	12W/m
LED QTY	120LED/m
Input voltage	DC24V
PCB width	8mm
System Luminous flux	75Lm/w
CRI	Ra>90/95
Cut length	One LED one cut

Product performance

Saturation red reduction degree	R9=90
Color Accuracy	Rf≥92
Color Saturation	Rg=99
Color tolerance	SDCM<3
Light Fixture Material	/
Installation	Paving or aluminum groove



LB5050-24/12-12W-60RGB



Product information

Power	12W/m
LED QTY	60LED/m
Input voltage	DC24V
PCB width	12mm
System Luminous flux	90Lm/w
CRI	Ra>90/95
Cut length	One LED one cut

Product performance

Saturation red reduction degree	R9=90
Color Accuracy	Rf≥92
Color Saturation	Rg=99
Color tolerance	SDCM<3
Light Fixture Material	/
Installation	Paving or aluminum groove



LB5050-24/12-12W-60RGBCW



Product information

Power	12W/m
LED QTY	60LED/m
Input voltage	DC24V
PCB width	12mm
System Luminous flux	90Lm/w
CRI	Ra>90/95
Cut length	One LED one cut

Product performance

Saturation red reduction degree	R9=90
Color Accuracy	Rf≥92
Color Saturation	Rg=99
Color tolerance	SDCM<3
Light Fixture Material	/
Installation	Paving or aluminum groove

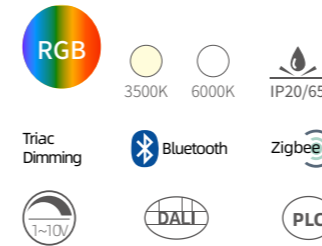

LB5050-24/12-15W-60RGBW



Product information

Power	15W/m
LED QTY	60LED/m
Input voltage	DC24V
PCB width	12mm
System Luminous flux	72Lm/w
CRI	Ra>90/95
Cut length	One LED one cut

Product performance

Saturation red reduction degree	R9=90
Color Accuracy	Rf≥92
Color Saturation	Rg=99
Color tolerance	SDCM<3
Light Fixture Material	/
Installation	Paving or aluminum groove



LINEAR PROFILE SERIES



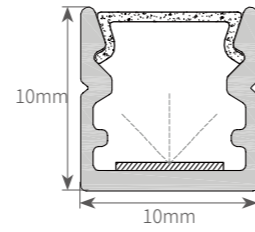
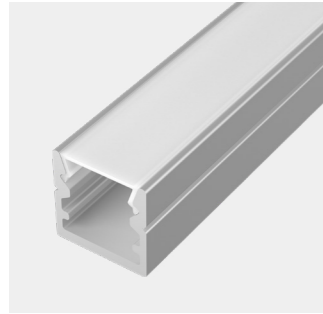

M1010

standard length of aluminum groove: 1m/1.5m/2m

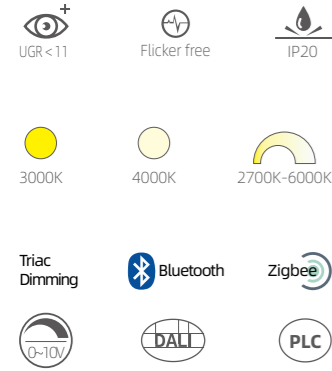

Product information

Power	10W/12.5W/18W
Beam angle	110°
Input voltage	DC 24V
Input frequency	50/60Hz
System Luminous flux	>100Lm/w
CRI	Ra > 90
Length	1000/1500/2000mm
Finish color	white/silver/black

Product performance

Saturation red reduction degree	R9=90
Color Accuracy	Rf ≥ 92
Color Saturation	Rg=99
Color tolerance	SDCM < 3
Light Fixture Material	Aluminium + PC diffuser
Installation	Surface Mounted

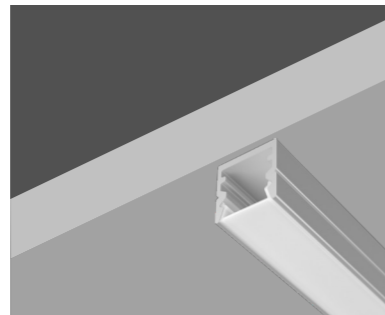

Installation steps

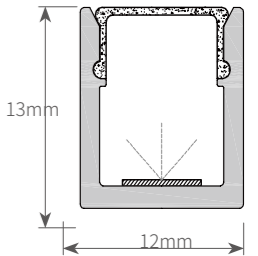
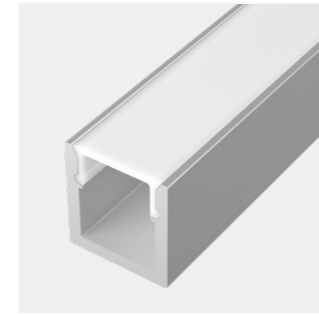
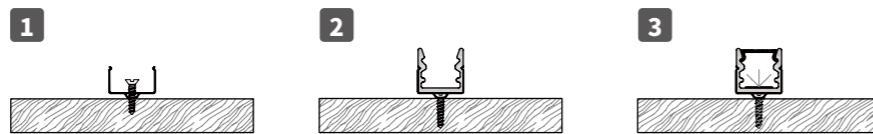

M1213

standard length of aluminum groove: 1m/1.5m/2m

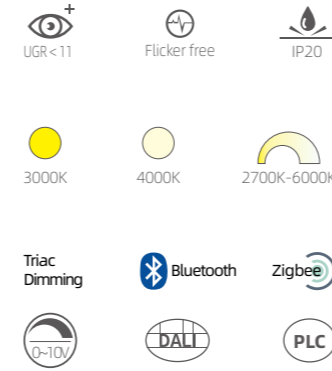

Product information

Power	10W/12.5W/18W
Beam angle	110°
Input voltage	DC 24V
Input frequency	50/60Hz
System Luminous flux	>100Lm/w
CRI	Ra > 90
Length	1000/1500/2000mm
Finish color	white/silver/black

Product performance

Saturation red reduction degree	R9=90
Color Accuracy	Rf ≥ 92
Color Saturation	Rg=99
Color tolerance	SDCM < 3
Light Fixture Material	Aluminium + PC diffuser
Installation	Surface Mounted



Installation steps

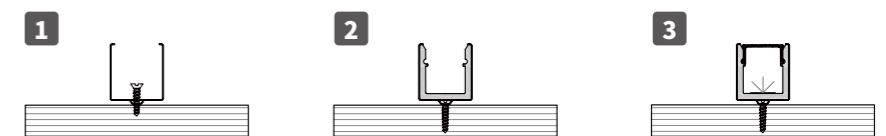

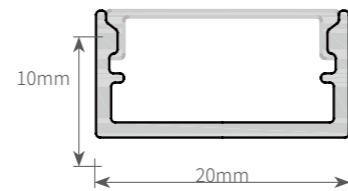
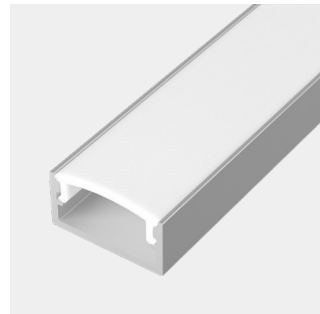

M2010

standard length of aluminum groove: 1m/1.5m/2m

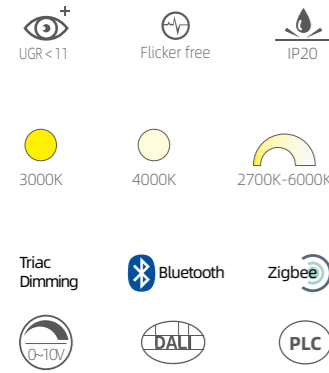

Product information

Power	10W/12.5W/18W
Beam angle	110°
Input voltage	DC 24V
Input frequency	50/60Hz
System Luminous flux	>100Lm/w
CRI	Ra>90
Length	1000/1500/2000mm
Finish color	white/silver/black

Product performance

Saturation red reduction degree	R9=90
Color Accuracy	Rf≥92
Color Saturation	Rg=99
Color tolerance	SDCM<3
Light Fixture Material	Aluminium + PC diffuser
Installation	Surface Mounted

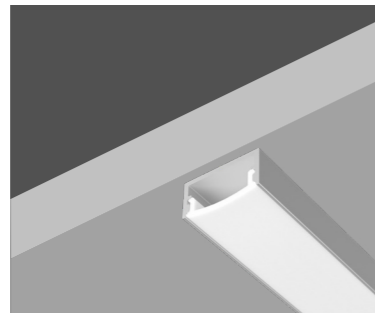

Installation steps

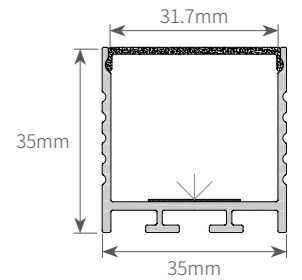
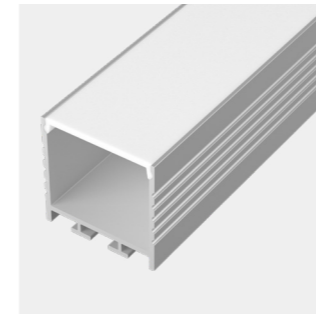
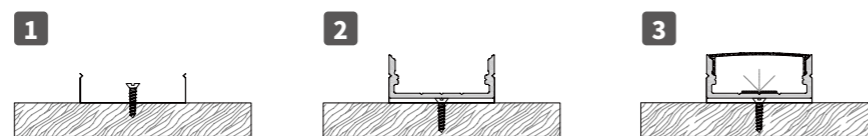

M3535

standard length of aluminum groove: 1m/1.5m/2m

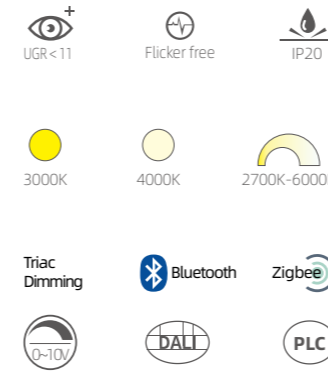

Product information

Power	24W/36W/48W
Beam angle	110°
Input voltage	DC 24V
Input frequency	50/60Hz
System Luminous flux	>100Lm/w
CRI	Ra>90
Length	1000/1500/2000mm
Finish color	white/silver/black

Product performance

Saturation red reduction degree	R9=90
Color Accuracy	Rf≥92
Color Saturation	Rg=99
Color tolerance	SDCM<3
Light Fixture Material	Aluminium + PC diffuser
Installation	Surface Mounted

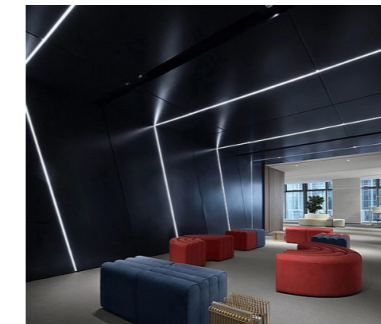

Installation steps

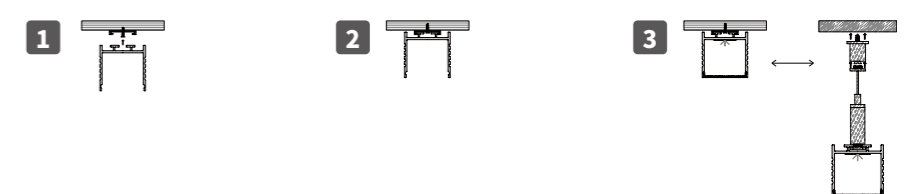

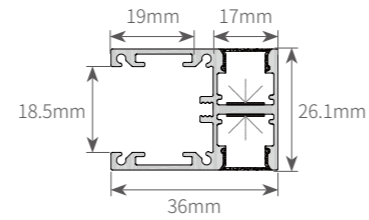
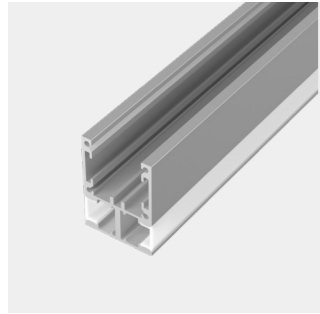

M3626

standard length of aluminum groove: 1m/1.5m/2m

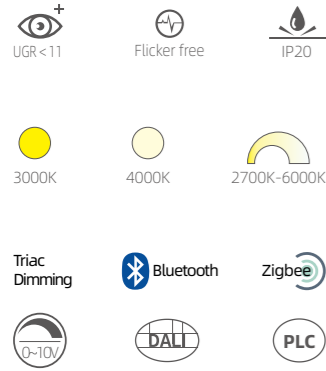

Product information

Power	Up 10/12.5/18W + Down 10/12.5/18W
Beam angle	110°
Input voltage	DC 24V
Input frequency	50/60Hz
System Luminous flux	>100Lm/w
CRI	Ra > 90
Length	1000/1500/2000mm
Finish color	white/silver/black

Product performance

Saturation red reduction degree	R9=90
Color Accuracy	Rf ≥ 92
Color Saturation	Rg=99
Color tolerance	SDCM < 3
Light Fixture Material	Aluminium + PC diffuser
Installation	Surface Mounted

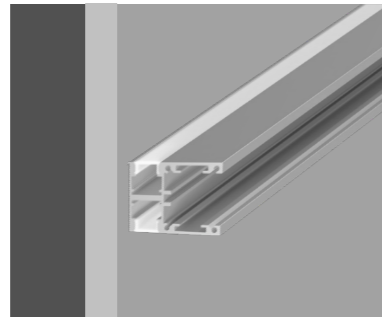

Installation steps

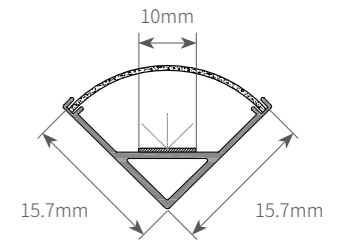
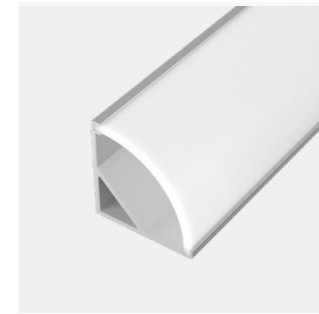
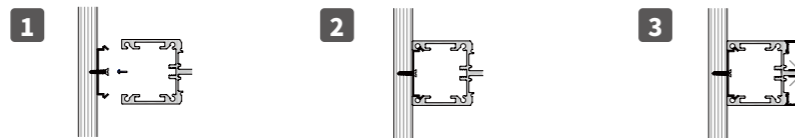

M1616

standard length of aluminum groove: 1m/1.5m/2m

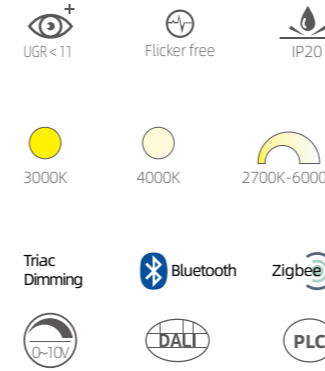

Product information

Power	10W/12.5W/18W
Beam angle	110°
Input voltage	DC 24V
Input frequency	50/60Hz
System Luminous flux	>100Lm/w
CRI	Ra > 90
Length	1000/1500/2000mm
Finish color	white/silver/black

Product performance

Saturation red reduction degree	R9=90
Color Accuracy	Rf ≥ 92
Color Saturation	Rg=99
Color tolerance	SDCM < 3
Light Fixture Material	Aluminium + PC diffuser
Installation	Surface Mounted



Installation steps

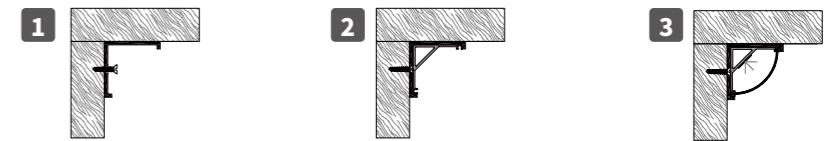

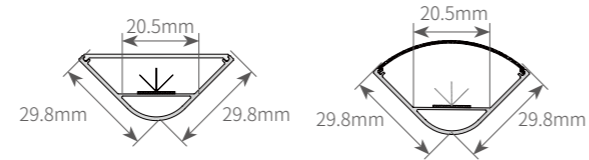
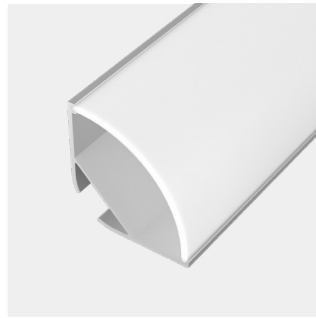

M3030

standard length of aluminum groove: 1m/1.5m/2m

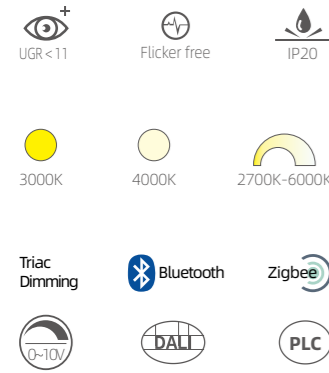

Product information

Power	10W/12.5W/18W
Beam angle	110°
Input voltage	DC 24V
Input frequency	50/60Hz
System Luminous flux	>100Lm/w
CRI	Ra > 90
Length	1000/1500/2000mm
Finish color	white/silver/black

Product performance

Saturation red reduction degree	R9=90
Color Accuracy	Rf ≥ 92
Color Saturation	Rg=99
Color tolerance	SDCM < 3
Light Fixture Material	Aluminium + PC diffuser
Installation	Surface Mounted



Installation steps

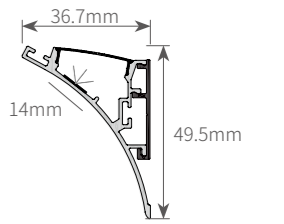
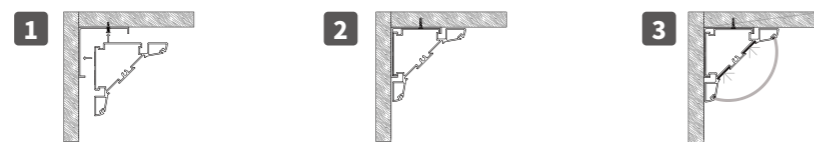

M5036

standard length of aluminum groove: 1m/1.5m/2m

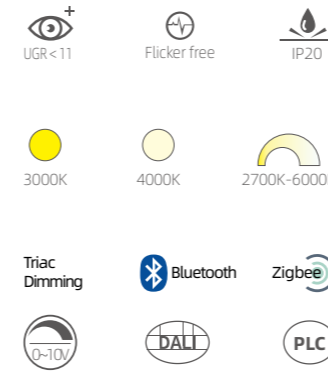

Product information

Power	10W/12.5W/18W
Beam angle	110°
Input voltage	DC 24V
Input frequency	50/60Hz
System Luminous flux	>100Lm/w
CRI	Ra > 90
Length	1000/1500/2000mm
Finish color	white/silver/black

Product performance

Saturation red reduction degree	R9=90
Color Accuracy	Rf ≥ 92
Color Saturation	Rg=99
Color tolerance	SDCM < 3
Light Fixture Material	Aluminium + PC diffuser
Installation	Surface Mounted

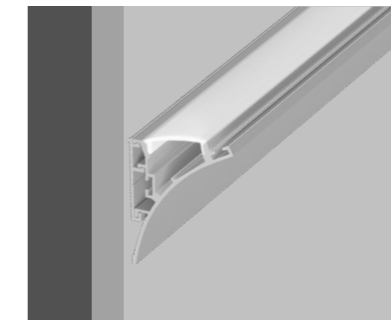

Installation steps

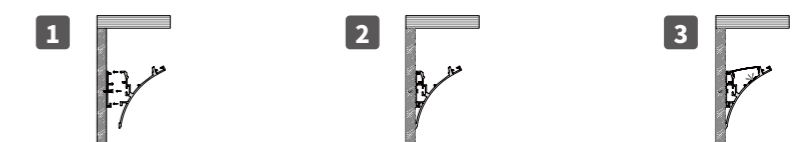

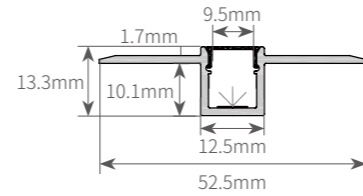
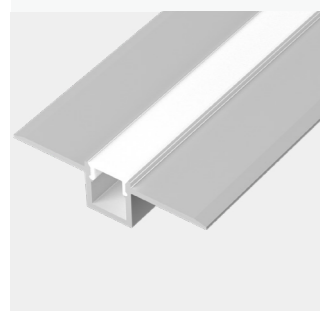

C5315

standard length of aluminum groove: 1m/1.5m/2m

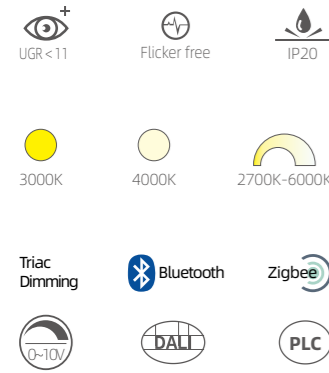

Product information

Power	10W/12.5W/18W
Beam angle	110°
Input voltage	DC 24V
Input frequency	50/60Hz
System Luminous flux	>100Lm/w
CRI	Ra>90
Length	1000/1500/2000mm
Finish color	white/silver/black

Product performance

Saturation red reduction degree	R9=90
Color Accuracy	Rf≥92
Color Saturation	Rg=99
Color tolerance	SDCM<3
Light Fixture Material	Aluminium + PC diffuser
Installation	Recessed

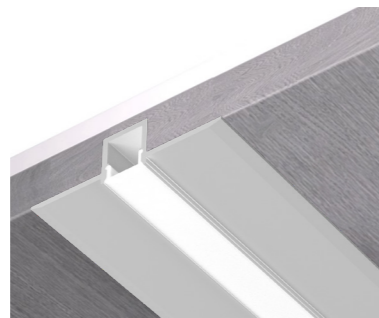

Installation steps

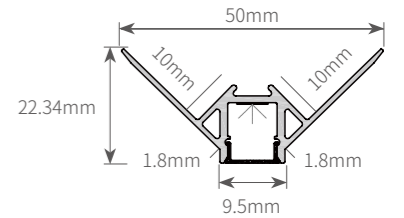

C5022

standard length of aluminum groove: 1m/1.5m/2m

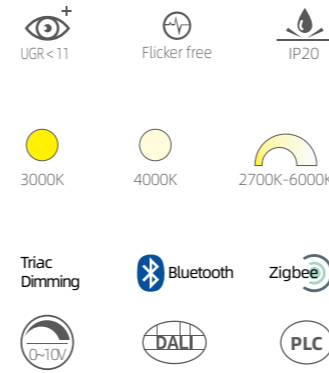

Product information

Power	10W/12.5W/18W
Beam angle	110°
Input voltage	DC 24V
Input frequency	50/60Hz
System Luminous flux	>100Lm/w
CRI	Ra>90
Length	1000/1500/2000mm
Finish color	white/silver/black

Product performance

Saturation red reduction degree	R9=90
Color Accuracy	Rf≥92
Color Saturation	Rg=99
Color tolerance	SDCM<3
Light Fixture Material	Aluminium + PC diffuser
Installation	Recessed

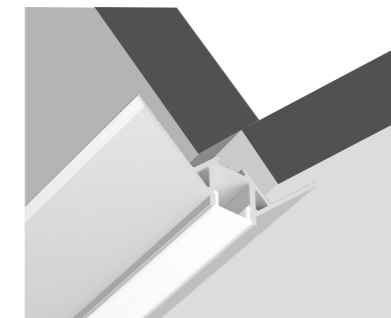

Installation steps



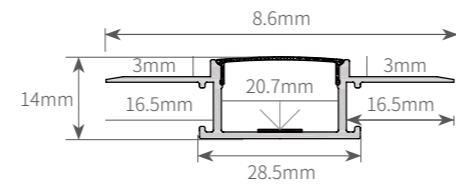
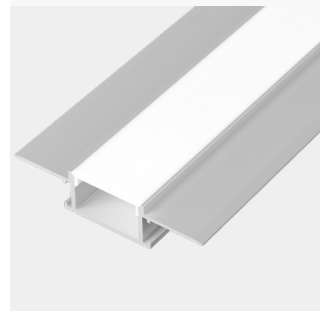

C6214

standard length of aluminum groove: 1m/1.5m/2m

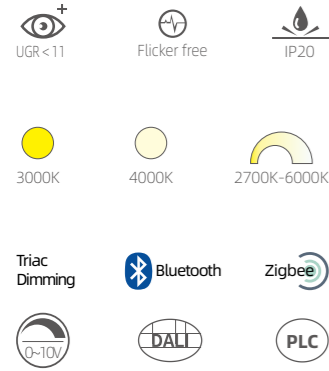

Product information

Power	10W/12.5W/18W
Beam angle	110°
Input voltage	DC 24V
Input frequency	50/60Hz
System Luminous flux	>100Lm/w
CRI	Ra>90
Length	1000/1500/2000mm
Finish color	white/silver/black

Product performance

Saturation red reduction degree	R9=90
Color Accuracy	Rf≥92
Color Saturation	Rg=99
Color tolerance	SDCM<3
Light Fixture Material	Aluminium + PC diffuser
Installation	Recessed

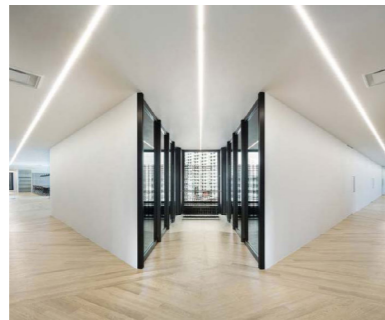

Installation steps

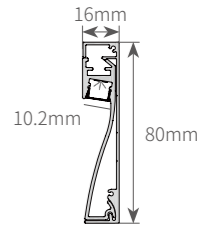
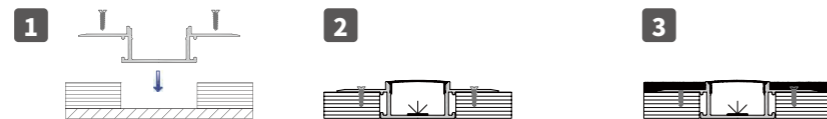

C8016

standard length of aluminum groove: 1m/1.5m/2m

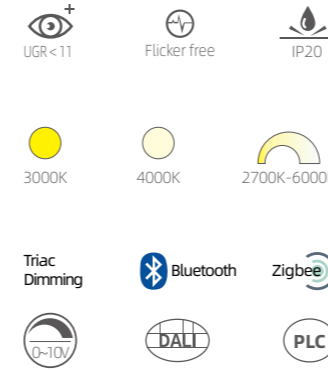

Product information

Power	10W/12.5W/18W
Beam angle	110°
Input voltage	DC 24V
Input frequency	50/60Hz
System Luminous flux	>100Lm/w
CRI	Ra>90
Length	1000/1500/2000mm
Finish color	white/silver/black

Product performance

Saturation red reduction degree	R9=90
Color Accuracy	Rf≥92
Color Saturation	Rg=99
Color tolerance	SDCM<3
Light Fixture Material	Aluminium + PC diffuser
Installation	Recessed



Installation steps

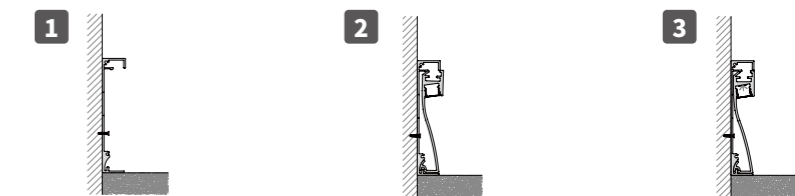

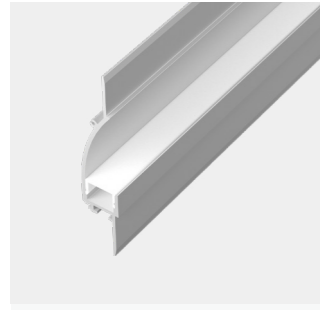

C9719

standard length of aluminum groove: 1m/1.5m/2m

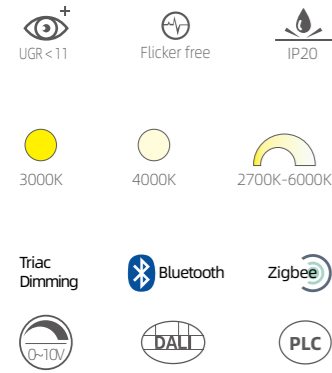
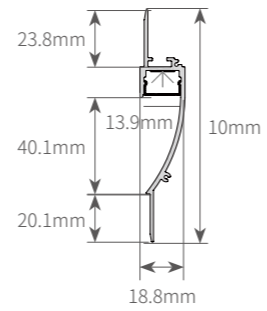

Product information

Power	10W/12.5W/18W
Beam angle	110°
Input voltage	DC 24V
Input frequency	50/60Hz
System Luminous flux	>100Lm/w
CRI	Ra > 90
Length	1000/1500/2000mm
Finish color	white/silver/black

Product performance

Saturation red reduction degree	R9=90
Color Accuracy	Rf ≥ 92
Color Saturation	Rg=99
Color tolerance	SDCM < 3
Light Fixture Material	Aluminium + PC diffuser
Installation	Recessed

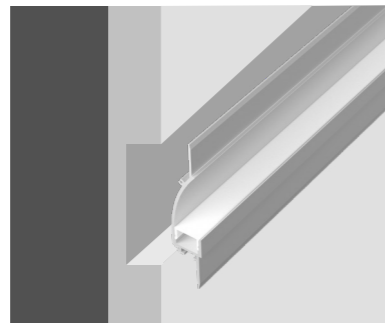

Installation steps

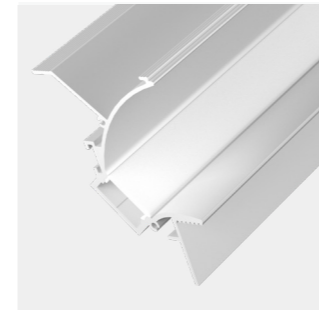
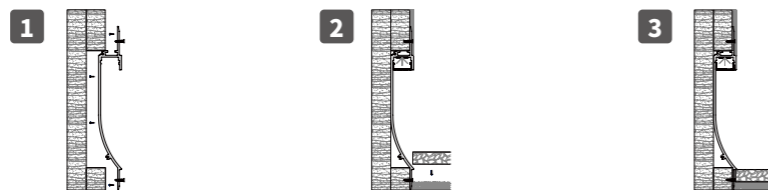

C8958

standard length of aluminum groove: 1m/1.5m/2m

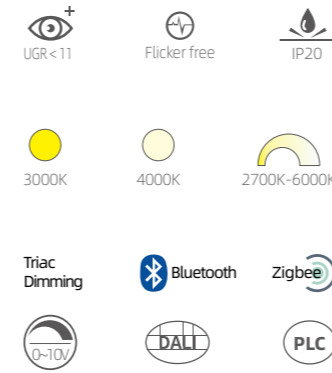
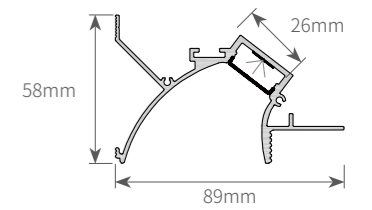

Product information

Power	24W/36W/48W
Beam angle	110°
Input voltage	DC 24V
Input frequency	50/60Hz
System Luminous flux	>100Lm/w
CRI	Ra > 90
Length	1000/1500/2000mm
Finish color	white/silver/black

Product performance

Saturation red reduction degree	R9=90
Color Accuracy	Rf ≥ 92
Color Saturation	Rg=99
Color tolerance	SDCM < 3
Light Fixture Material	Aluminium + PC diffuser
Installation	Recessed

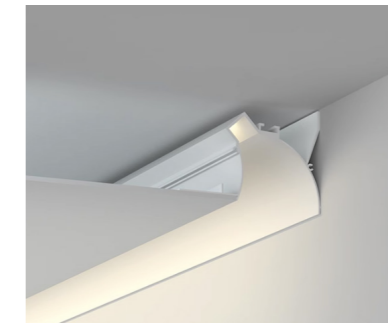

Installation steps

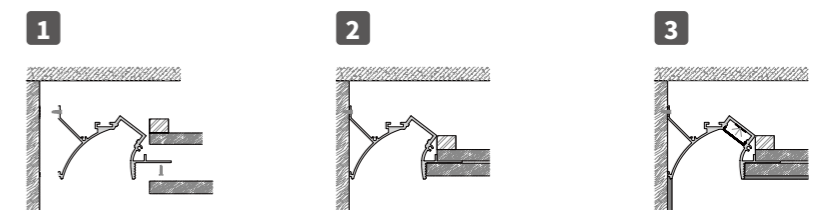

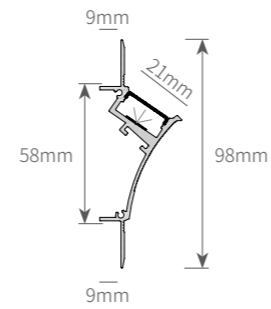
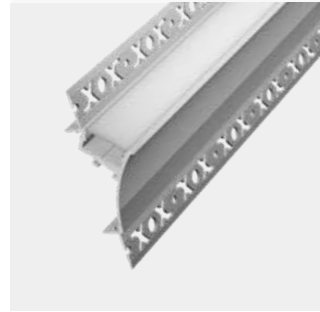

C9835

standard length of aluminum groove: 1m/1.5m/2m

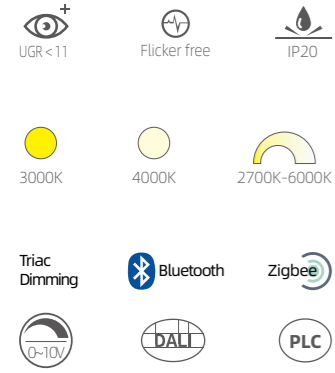

Product information

Power	24W/36W/48W
Beam angle	110°
Input voltage	DC 24V
Input frequency	50/60Hz
System Luminous flux	>100Lm/w
CRI	Ra>90
Length	1000/1500/2000mm
Finish color	white/silver/black

Product performance

Saturation red reduction degree	R9=90
Color Accuracy	Rf≥92
Color Saturation	Rg=99
Color tolerance	SDCM<3
Light Fixture Material	Aluminium + PC diffuser
Installation	Recessed

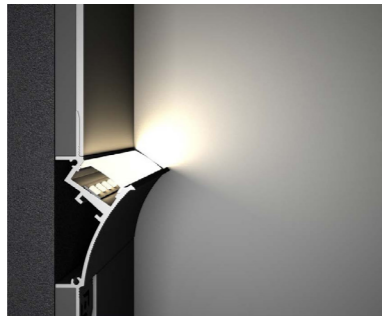

Installation steps

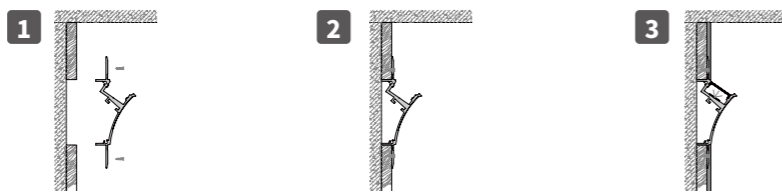

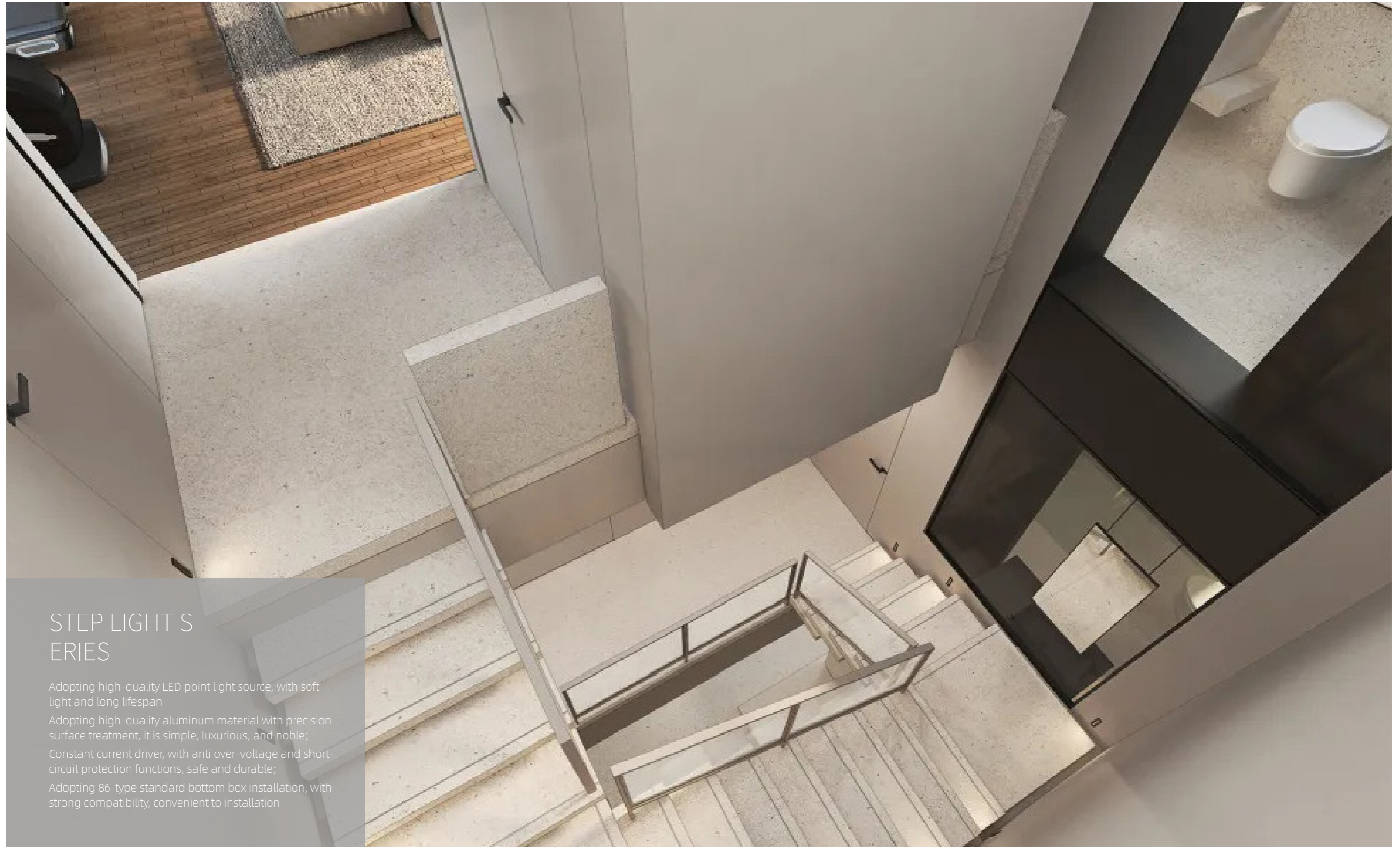

STEP LIGHT SERIES

Adopting high-quality LED point light source, with soft light and long lifespan

Adopting high-quality aluminum material with precision surface treatment, it is simple, luxurious, and noble;

Constant current driver, with anti over-voltage and short-circuit protection functions, safe and durable;

Adopting 86-type standard bottom box installation, with strong compatibility, convenient to installation



FL03-L-S

Selective Color

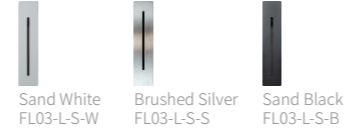

Product information

Power	2W
Beam angle	10°
Input voltage	AC 100-240V
Input frequency	50/60Hz
System Luminous flux	16Lm/w
CRI	Ra>90
Finish color	/

Product performance

Saturation red reduction degree	R9=90
Color Accuracy	Rf≥92
Color Saturation	Rg=99
Color tolerance	SDCM<3
Light Fixture Material	Aluminium
Installation	Recessed



FL04-L-L

Selective Color



Product information

Power	3W
Beam angle	90°
Input voltage	AC 100-240V
Input frequency	50/60Hz
System Luminous flux	16Lm/w
CRI	Ra>90
Finish color	/

Product performance

Saturation red reduction degree	R9=90
Color Accuracy	Rf≥92
Color Saturation	Rg=99
Color tolerance	SDCM<3
Light Fixture Material	Aluminium
Installation	Recessed

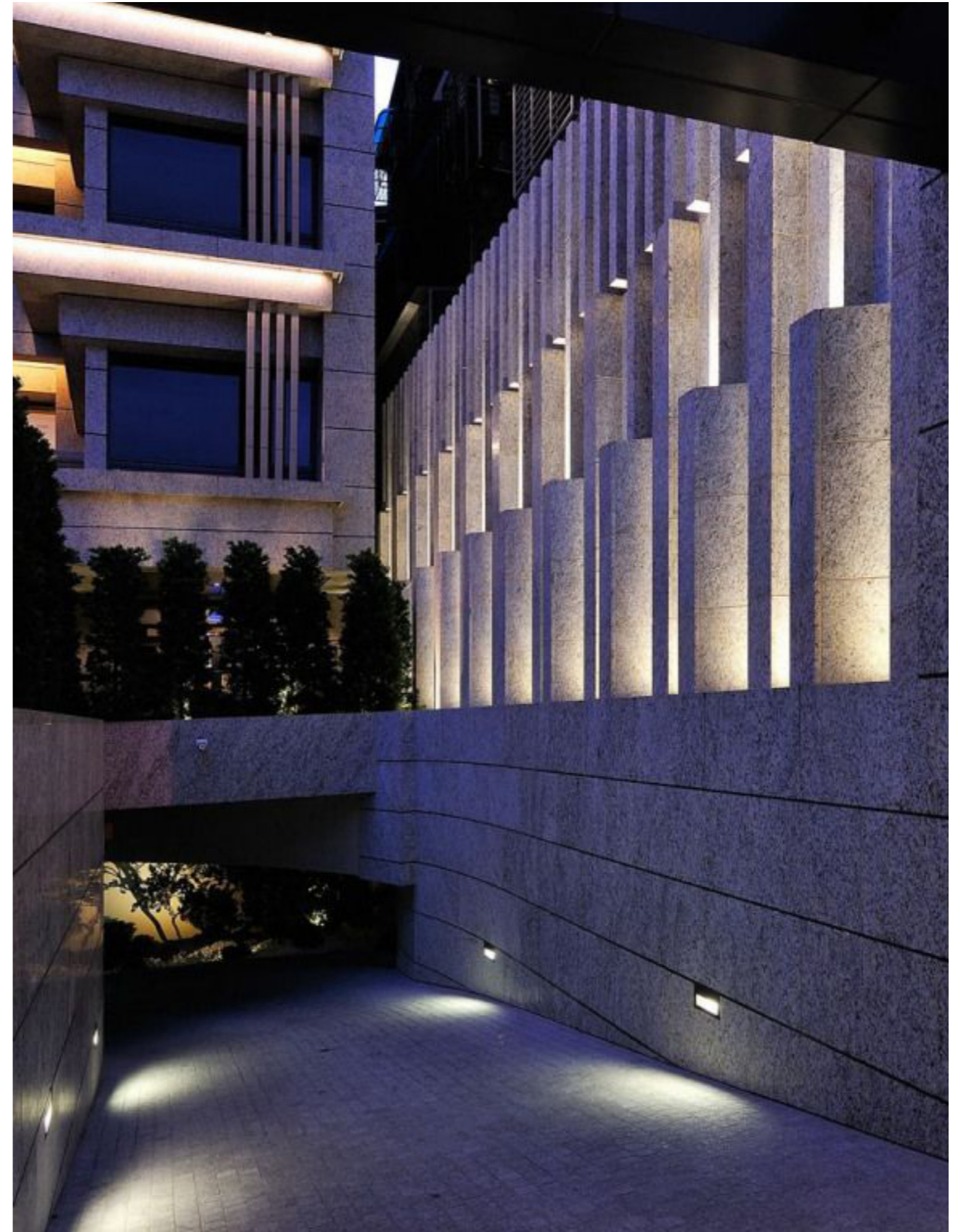

OFFICE LINEAR LIGHT SERIES



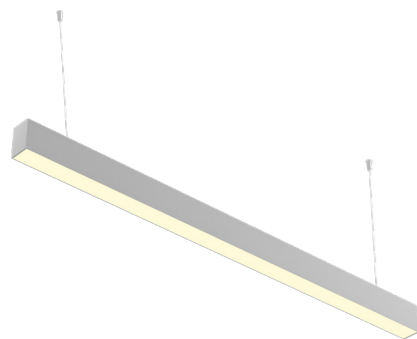

BM5075

Product information

Power	36W
Beam angle	110°
Input voltage	AC 200-240V
Input frequency	50Hz
System Luminous flux	85Lm/w
CRI	Ra>90
Lamp size	L1200xW50xH75mm
Finish color	White/Silver/Black

Product performance

Saturation red reduction degree	R9=90
Color Accuracy	Rf≥92
Color Saturation	Rg=99
Color tolerance	SDCM<3
Light Fixture Material	Aluminium
Installation	suspension wire/suspension rod

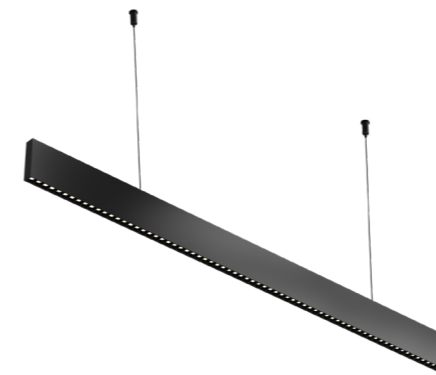
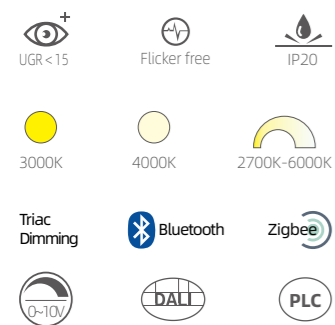

BM1670

Product information

Power	36W
Beam angle	15/30/45°
Input voltage	AC 200-240V
Input frequency	50Hz
System Luminous flux	75Lm/w
CRI	Ra>90
Lamp size	L1200xW16xH70mm
Finish color	White/Silver/Black

Product performance

Saturation red reduction degree	R9=90
Color Accuracy	Rf≥92
Color Saturation	Rg=99
Color tolerance	SDCM<3
Light Fixture Material	Aluminium
Installation	suspension wire/suspension rod

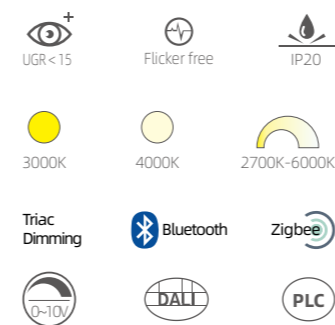

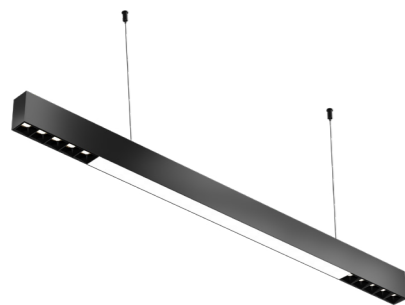

BM4375

Product information

Power	36W
Beam angle	30°/110°
Input voltage	AC 200-240V
Input frequency	50Hz
System Luminous flux	85Lm/w
CRI	Ra>90
Lamp size	L1200xW43xH75mm
Finish color	White/Silver/Black

Product performance

Saturation red reduction degree	R9=90
Color Accuracy	Rf≥92
Color Saturation	Rg=99
Color tolerance	SDCM<3
Light Fixture Material	Aluminium
Installation	suspension wire/suspension rod

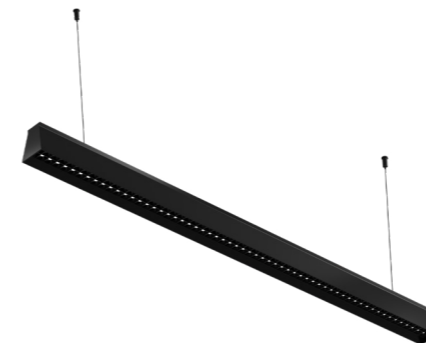
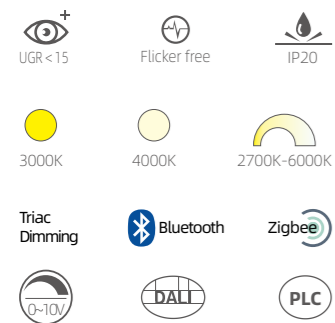

M6270

Product information

Power	36W
Beam angle	15/30/45°
Input voltage	AC 200-240V
Input frequency	50Hz
System Luminous flux	75Lm/w
CRI	Ra>90
Lamp size	L1200xW62xH70mm
Finish color	White/Silver/Black

Product performance

Saturation red reduction degree	R9=90
Color Accuracy	Rf≥92
Color Saturation	Rg=99
Color tolerance	SDCM<3
Light Fixture Material	Aluminium
Installation	suspension wire/suspension rod

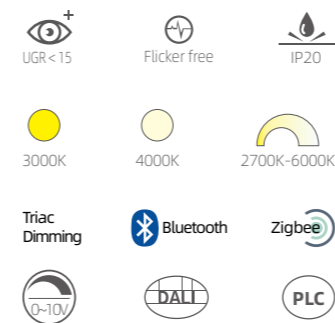

CLASSROOM LIGHT
PANEL LIGHT
Highbay AND STADIUM LIGHT SERIES





KWT-HB-040-N01

Product information

Power	28W/32W/36W/40W
Beam angle	/
Input voltage	AC 200-240V
Input frequency	/
System Luminous flux	/
CRI	Ra>90
Finish color	White+Titanium

Product performance

Saturation red reduction degree	R9=90
Color Accuracy	Rf≥92
Color Saturation	Rg=99
Color tolerance	SDCM<3
Light Fixture Material	Aluminium
Installation	suspension rod

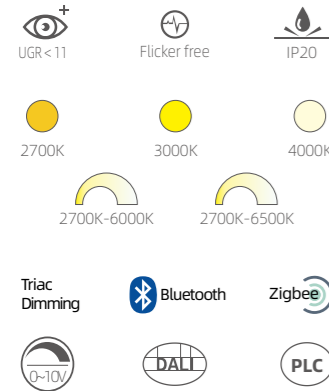

KWT-HB-040-N02

Product information

Power	28W/32W/36W/40W
Beam angle	/
Input voltage	AC 200-240V
Input frequency	/
System Luminous flux	/
CRI	Ra>90
Finish color	White+Titanium

Product performance

Saturation red reduction degree	R9=90
Color Accuracy	Rf≥92
Color Saturation	Rg=99
Color tolerance	SDCM<3
Light Fixture Material	Aluminium
Installation	suspension rod

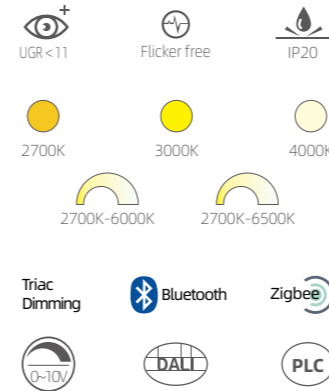

KWT-JS-040-N01

Product information

Power	28W/32W/36W
Beam angle	/
Input voltage	AC 200-240V
Input frequency	/
System Luminous flux	/
CRI	Ra>90
Finish color	White+Titanium

Product performance

Saturation red reduction degree	R9=90
Color Accuracy	Rf≥92
Color Saturation	Rg=99
Color tolerance	SDCM<3
Light Fixture Material	Aluminium
Installation	suspension rod/ceiling/wire suspension

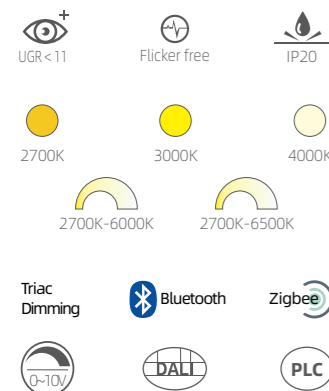

KWT-JS-040-N02

Product information

Power	28W/32W/36W/40W/54W
Beam angle	/
Input voltage	AC 200-240V
Input frequency	/
System Luminous flux	/
CRI	Ra>90
Finish color	White+Titanium

Product performance

Saturation red reduction degree	R9=90
Color Accuracy	Rf≥92
Color Saturation	Rg=99
Color tolerance	SDCM<3
Light Fixture Material	Aluminium
Installation	suspension rod

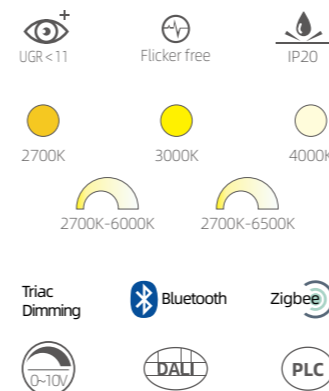

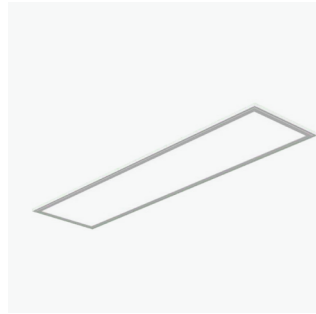

KWT-JS-040-N02

Product information

Power	28W/32W/36W/40W/54W
Beam angle	/
Input voltage	AC 200-240V
Input frequency	/
System Luminous flux	/
CRI	Ra>90
Finish color	White+Titanium

Product performance

Saturation red reduction degree	R9=90
Color Accuracy	Rf≥92
Color Saturation	Rg=99
Color tolerance	SDCM<3
Light Fixture Material	Aluminium
Installation	suspension rod/recessed/ceiling/wire suspension/ suspension ring

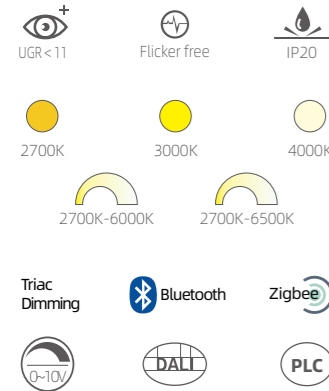

KWT-TD-015-N01

Product information

Power	15W
Beam angle	/
Input voltage	AC 200-240V
Input frequency	/
System Luminous flux	/
CRI	Ra>90
Finish color	White+Titanium

Product performance

Saturation red reduction degree	R9=90
Color Accuracy	Rf≥92
Color Saturation	Rg=99
Color tolerance	SDCM<3
Light Fixture Material	Aluminium
Installation	/

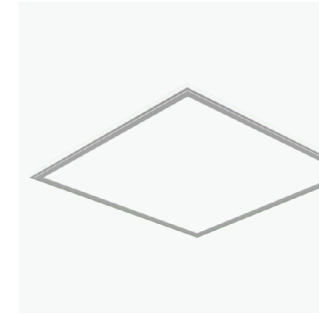
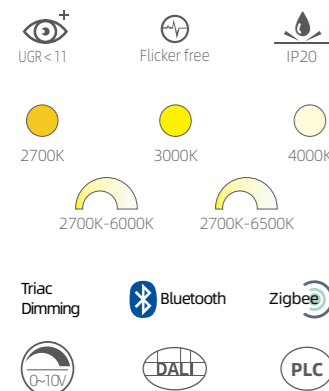

KWT-JS-036-N04

Product information

Power	28W/32W/36W/40W
Beam angle	/
Input voltage	AC 200-240V
Input frequency	/
System Luminous flux	/
CRI	Ra>90
Finish color	White+Titanium

Product performance

Saturation red reduction degree	R9=90
Color Accuracy	Rf≥92
Color Saturation	Rg=99
Color tolerance	SDCM<3
Light Fixture Material	Aluminium
Installation	suspension rod/recessed/ceiling/wire suspension/ suspension ring

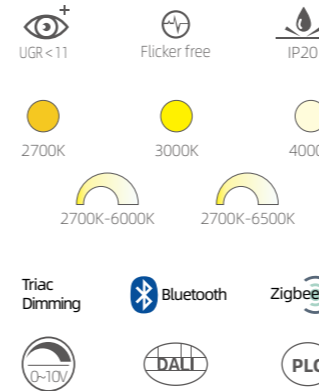

KWT-SP-0300

Product information

Power	100W/120W/150W/200W/250W/300W
Beam angle	/
Input voltage	AC 200-240V
Input frequency	/
System Luminous flux	/
CRI	Ra>80
Finish color	White+Titanium

Product performance

Saturation red reduction degree	R9=90
Color Accuracy	Rf≥92
Color Saturation	Rg=99
Color tolerance	SDCM<3
Light Fixture Material	Aluminium
Installation	suspension rod / suspension ring

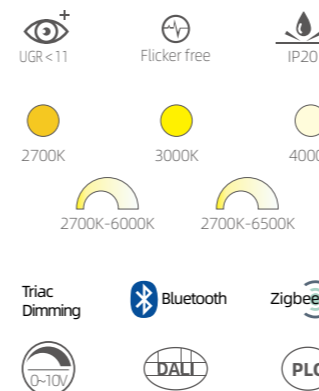



KWT-SP-1200

Product information

Power	600W/1200W
Beam angle	/
Input voltage	AC 200-240V
Input frequency	50/60Hz
System Luminous flux	/
CRI	Ra>80
Finish color	White+Titanium

Product performance

Saturation red reduction degree	R9=90
Color Accuracy	Rf≥92
Color Saturation	Rg=99
Color tolerance	SDCM<3
Light Fixture Material	Aluminium
Installation	/

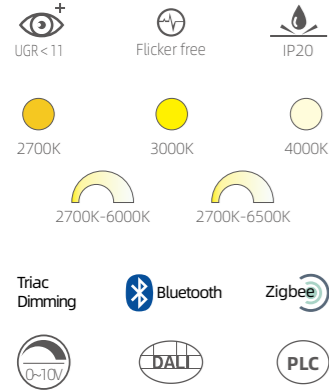

KWT-SP-0300B

Product information

Power	180W/240W/300W
Beam angle	/
Input voltage	AC 200-240V
Input frequency	50/60Hz
System Luminous flux	/
CRI	Ra>80
Finish color	White+Titanium

Product performance

Saturation red reduction degree	R9=90
Color Accuracy	Rf≥92
Color Saturation	Rg=99
Color tolerance	SDCM<3
Light Fixture Material	Aluminium
Installation	/

